

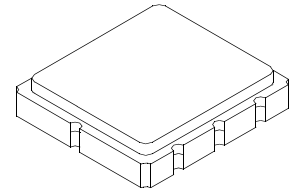



For prototype or pre-production sample please contact RFM Sales.

SF2072C

**360.00 MHz
SAW Filter**



SM5050-8

- **Designed for Broadband Receiver IF Applications**
- **Low Insertion Loss**
- **5.0 X 5.0 mm Surface-Mount Case**
- **Differential Input and Output**
- **Complies with Directive 2002/95/EC (RoHS)** 

Absolute Maximum Ratings

Rating	Value	Units
Maximum Incident Power in Passband	+13	dBm
Max. DC voltage between any 2 terminals	30	VDC
Storage Temperature Range	-40 to +85	°C
Suitable for lead-free soldering - Max Soldering Profile	260°C for 30 s	

Electrical Characteristics

Characteristic	Sym	Notes	Min	Typ	Max	Units
Nominal Center Frequency	CF			360.00		MHz
Insertion Loss				9	10.5	dB
Bandwidth 1 dB			30	36		MHz
Bandwidth 3 dB			36	40		MHz
Amplitude Ripple across 30 MHz				0.4		dB
Amplitude Ripple across any 10 MHz				0.75		dB
VSWR across fc ±15 MHz				1.7	2.2	
Group Delay Variation				40		nsec
	100 to 285 MHz			50		dB
	285 to 325 MHz		25	38		
	325 to 435 MHz		25	38		
	435 to ++			45		
Center Frequency Temperature Coefficient				-34		kHz/°C
Temperature	Operating		-40		85	°C
Case Style			SM5050-8 5 x 5 mm Nominal Footprint			
Lid Symbolization (YY=year, WW=week, S=shift)			RFM 649 YYWWS			

Notes:

1. Unless noted otherwise, all specifications apply over the operating temperature range with filter soldered to the specified demonstration board with impedance matching to 50 Ω and measured with 50 Ω network analyzer.
2. Rejection is measured as attenuation below the minimum IL point in the passband. Rejection in final user application is dependent on PCB layout and external impedance matching design. See Application Note No. 42 for details.
3. The design, manufacturing process, and specifications of this filter are subject to change.
4. Tape and Reel Standard ANSI / EIA 481.
5. US and international patents may apply.
6. RFM, stylized RFM logo, and RF Monolithics, Inc. are registered trademarks of RF Monolithics, Inc.
7. ©Copyright 1999, RF Monolithics Inc.
8. Electrostatic Sensitive Device. Observe precautions for handling.
9. The center of the bandwidths will move with ambient temperature. 

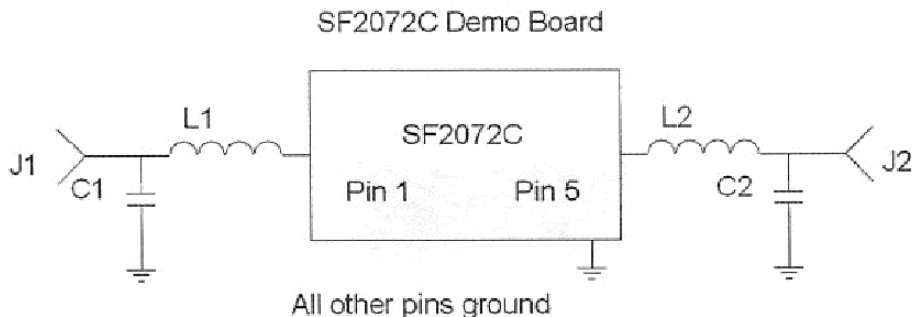

J1, J2=500-0248-001 4 Hole Flange SMA
 PCB=400-1592-001 Pin 1&5 Type 2 5x5
 C1,C2=10 pF 500-0003-100
 L1=33 nH 0805CS 500-0782-330
 L2=36 nH 0805CS 500-0782-360

21 Sep 2006 09:37:54

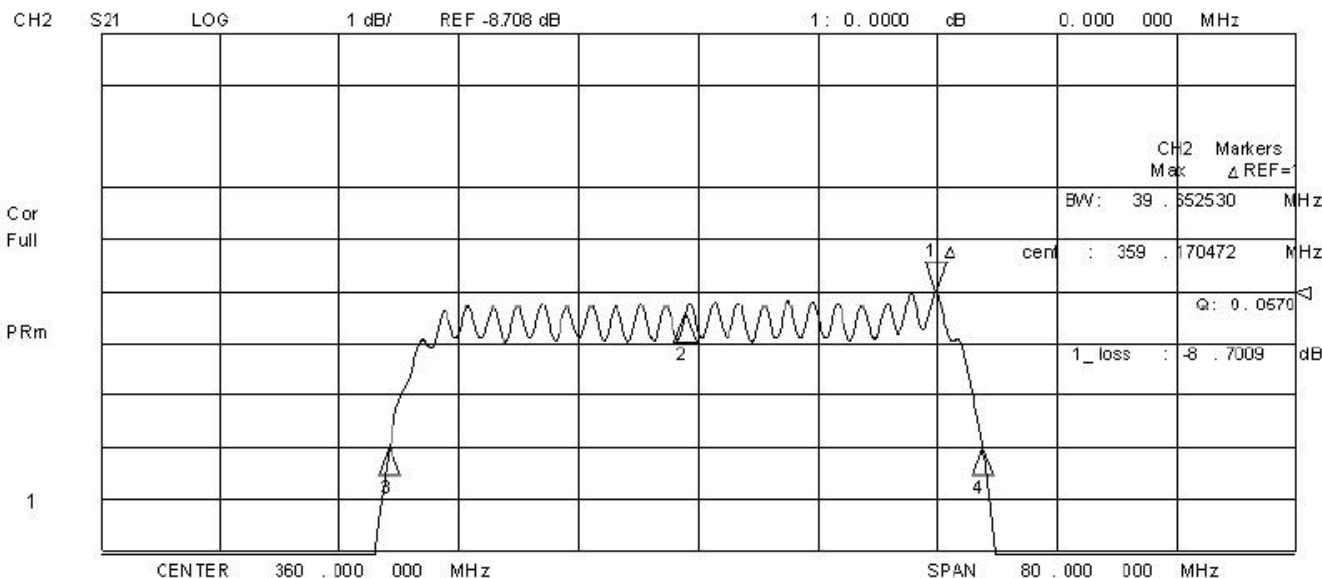
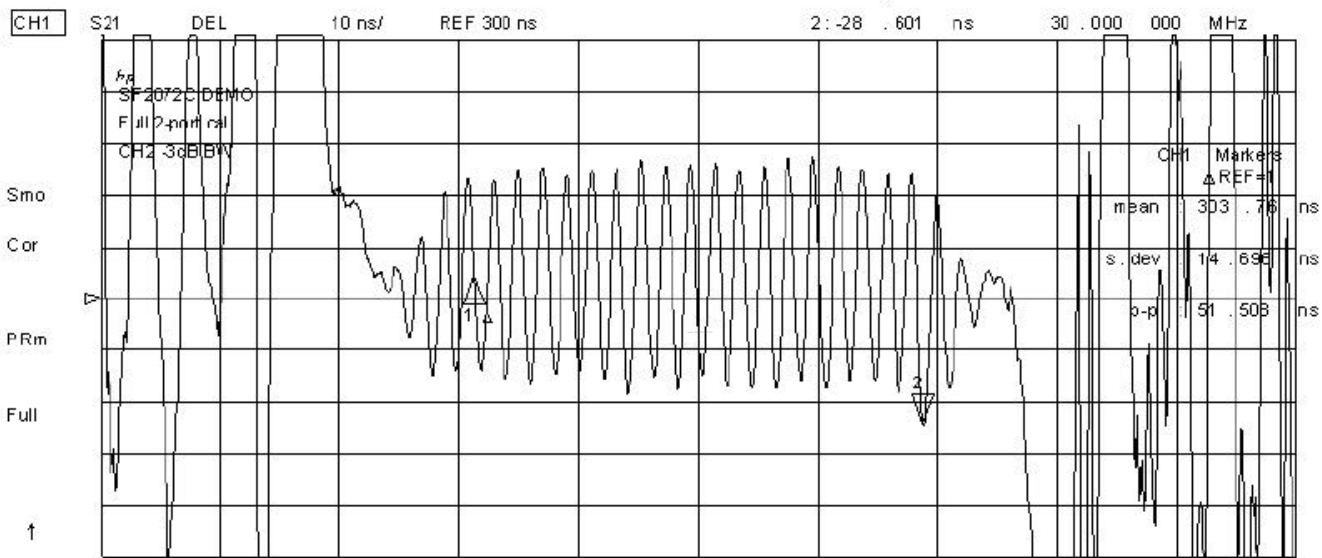

21 Sep 2006 09:31:29

CH1 S11 1 UFS

1: 70.449 Ω -31.391 Ω 14.064 pF

360.000 000 MHz

hp
SF2072C DEMO
Full 2-port cal

Cor

PRm

Full

↑

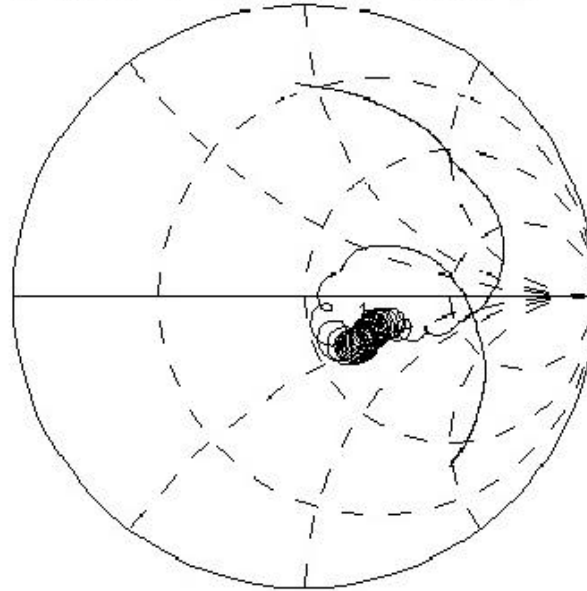

CH2 S22 1 UFS

1: 79.523 Ω -32.938 Ω 13.422 pF

360.000 000 MHz

Cor

Full

PRm

↑

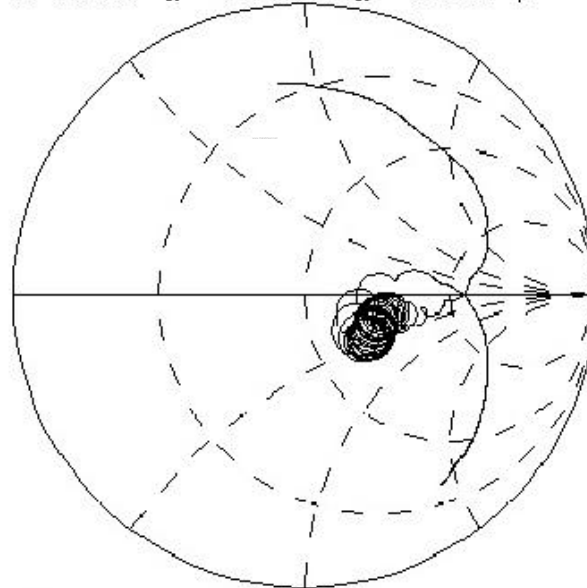

CENTER 360.000 000 MHz

SPAN 80.000 000 MHz

21 Sep 2006 09:41:58

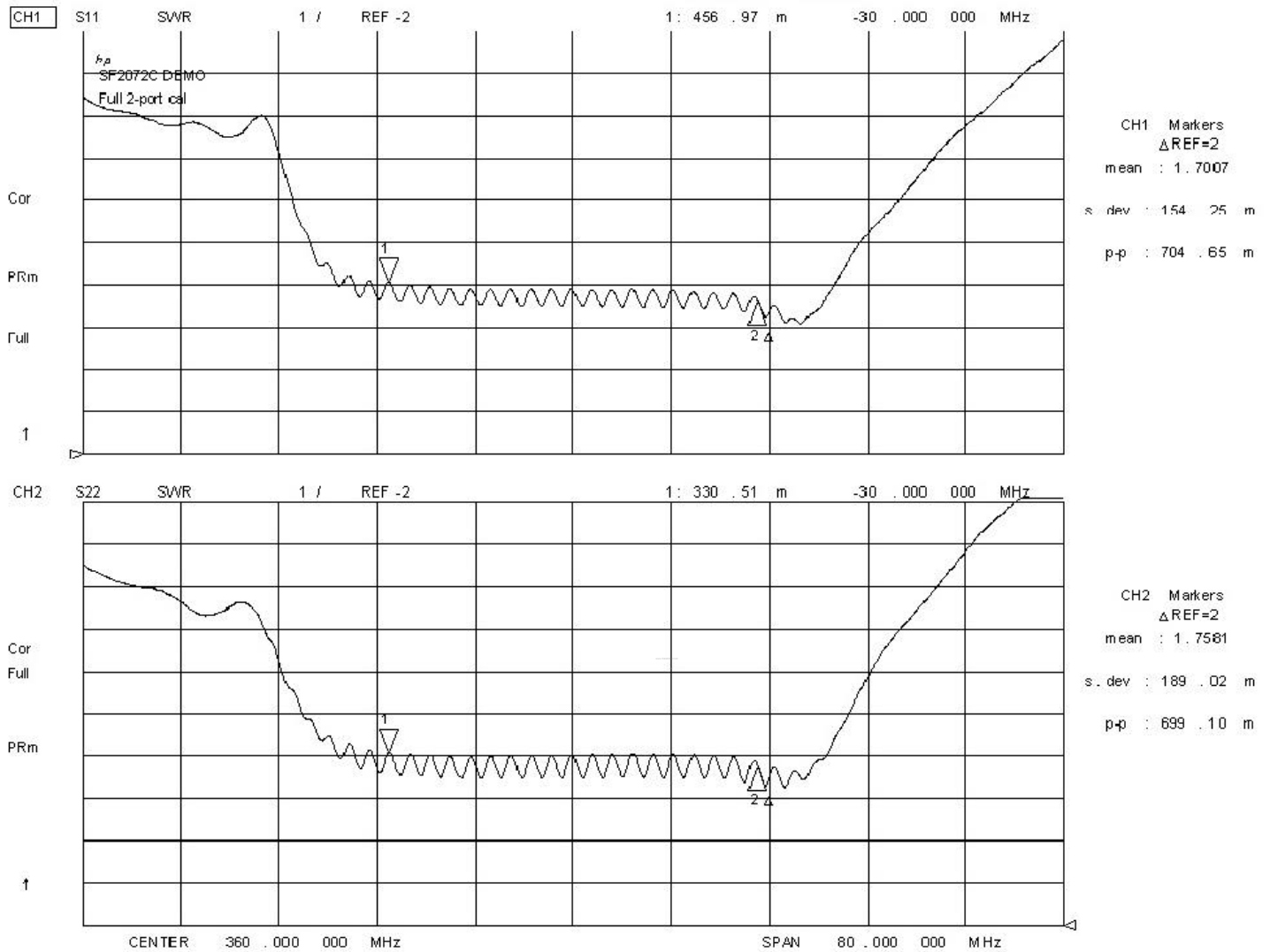

21 Sep 2006 09:29:52

CH2 S21 LOG 10 dB/ REF -40 dB 1: -8.5177 dB 374.250000 MHz

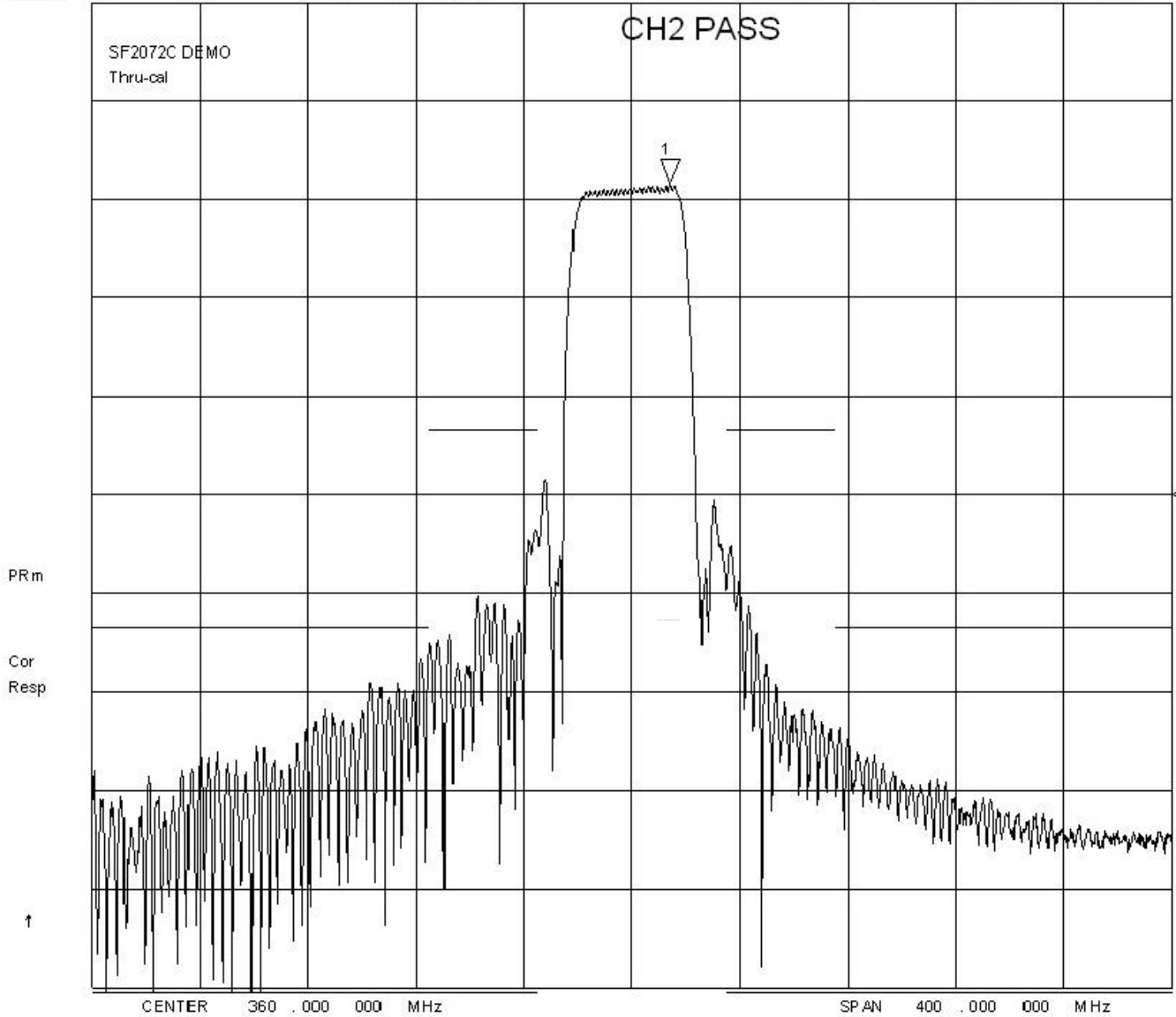

SM5050-8 Case

8-Terminal Ceramic Surface-Mount Case 5.0 X 5.0 mm Nominal Footprint

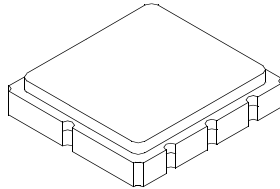

Case Dimensions

Dimension	mm			Inches		
	Min	Nom	Max	Min	Nom	Max
A	4.8	5.0	5.2		0.1968	
B	4.8	5.0	5.2		0.1968	
C			1.7			0.0669
D		2.08			0.0818	
E		1.17			0.046	
F		0.64			0.0252	
G	2.39	2.54	2.69		0.100	

Materials	
Solder Pad Termination	Au plating 30 - 60 ulnches (76.2-152 uM) over 80-200 ulnches (203-508 uM) Ni.
Lid	Fe-Ni-Co Alloy Electroless Nickel Plate (8-11% Phosphorus) 100-200 ulnches Thick
Body	Al ₂ O ₃ Ceramic
Pb Free	

Electrical Connections

Connection		Terminals
Port 1	Differential Input	2,3
Port 2	Differential Output	6,7
	Ground	All others
Single Ended Operation		Return is ground
Differential Operation		Return is hot
Dot indicates Pin 1		

TOP VIEW

BOTTOM VIEW

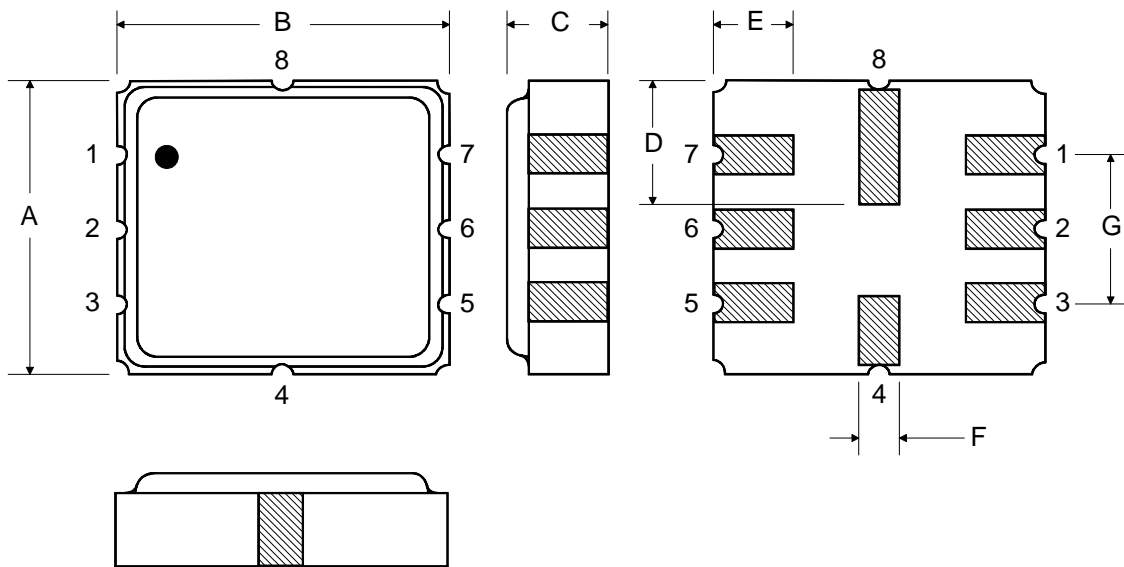

Tape and Reel Specifications

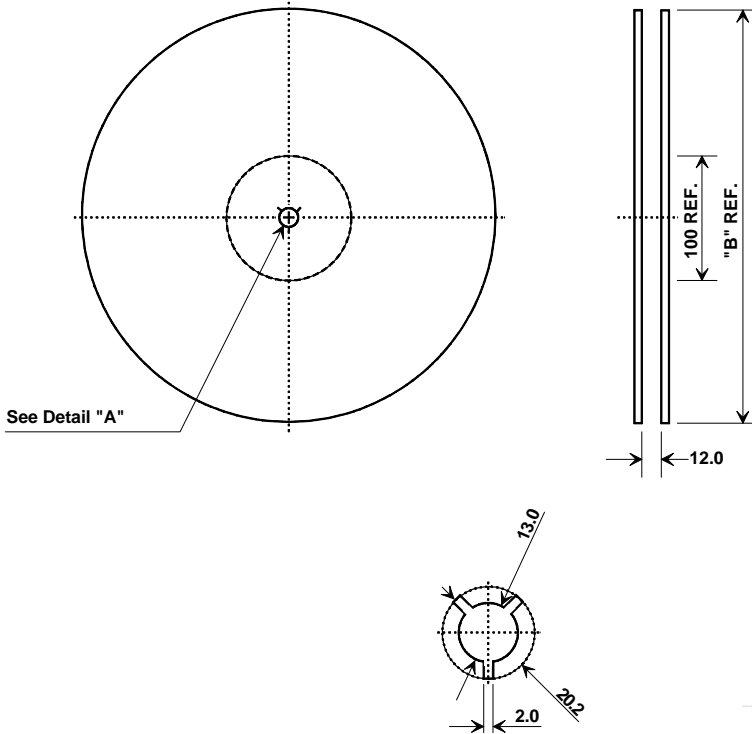

"B "		Quantity Per Reel
Nominal Size		
Inches	millimeters	
7	178	500
13	330	2000

COMPONENT ORIENTATION and DIMENSIONS

Carrier Tape Dimensions	
Ao	5.3 mm
Bo	5.3 mm
Ko	2.0 mm
Pitch	8.0 mm
W	12.0 mm

