

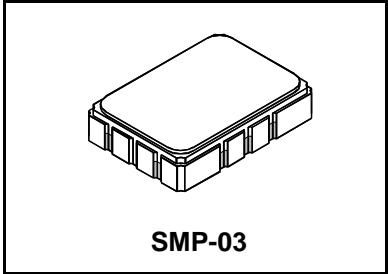

**SF2073B**

**456.00 MHz  
SAW Filter**



- **Designed for 802.16 and WIMAX Receiver IF Application**
- **Low Insertion Loss**
- **5.0 X 7.0 mm Surface-Mount Case**
- **Differential or Single Ended Input and Output**
- **Complies with Directive 2002/95/EC (RoHS)**

**Absolute Maximum Ratings**

Rating	Value	Units
Maximum Incident Power in Passband	+13	dBm
Max. DC voltage between any 2 terminals	30	VDC
Storage Temperature Range	-40 to +85	°C
Suitable for lead-free soldering - Max Soldering Temperature	260°C for 30 s	

**Electrical Characteristics**

Characteristic	Sym	Notes	Min	Typ	Max	Units
Nominal Frequency	$f_N$	1		456.000		MHz
Minimum Insertion Attenuation	$\alpha_{min}$	1		12.5	14.5	dB
Amplitude Variation	$f_N \pm 5.0$ MHz	$\Delta\alpha$	1	0.6	1.5	dB p-p
			1	0.8	2.5	
Absolute Group Delay (at $f_N$ )		1		0.5	0.7	$\mu$ s
Group Delay Variation (p-p)	$f_N \pm 5.0$ MHz	1		35	100	ns
Relative Attenuation	256 to 360 MHz	1, 2	35	50	dB	
			360 to 416.0 MHz	38		64
			416 to 443 MHz	35		40
			468 to 656 MHz	35		40
			656 to 946 MHz	50		60
Temperature Range	Operating		-40		85	°C
			Storage	-40		
Case Style	SMP-03 7 x 5 mm Nominal Footprint					
Lid Symbolization (YY=year, WW=week, S=shift)	RFM SF2073B YYWWS					

- I. 200 ohm Matching .....page 2
- II. 50 ohm Matching .....page 4
- III. SMI 7035 Matching .....page 6

**Notes:**

1. Unless noted otherwise, all specifications apply over the operating temperature range.
2. Rejection is measured as attenuation below the minimum IL point in the passband. Rejection in final user application is dependent on PCB layout and external impedance matching design. See Application Note No. 42 for details.
3. The design, manufacturing process, and specifications of this filter are subject to change.
4. Tape and Reel Standard ANSI / EIA 481.
5. Either Port 1 or Port 2 may be used for either input or output in the design. However, impedances and impedance matching may vary between Port 1 and Port 2, so that the filter must always be installed in one direction per the circuit design.
6. US and international patents may apply.
7. RFM, stylized RFM logo, and RF Monolithics, Inc. are registered trademarks of RF Monolithics, Inc.
8. ©Copyright 1999, RF Monolithics Inc.
9. Electrostatic Sensitive Device. Observe precautions for handling.

## I. Impedance Matching for Differential 200 Ohm Load: Coilcraft Inductors

(SAW Matched to 200 Ohms Balanced, 4:1 Transformers Account for 2dB of Loss)

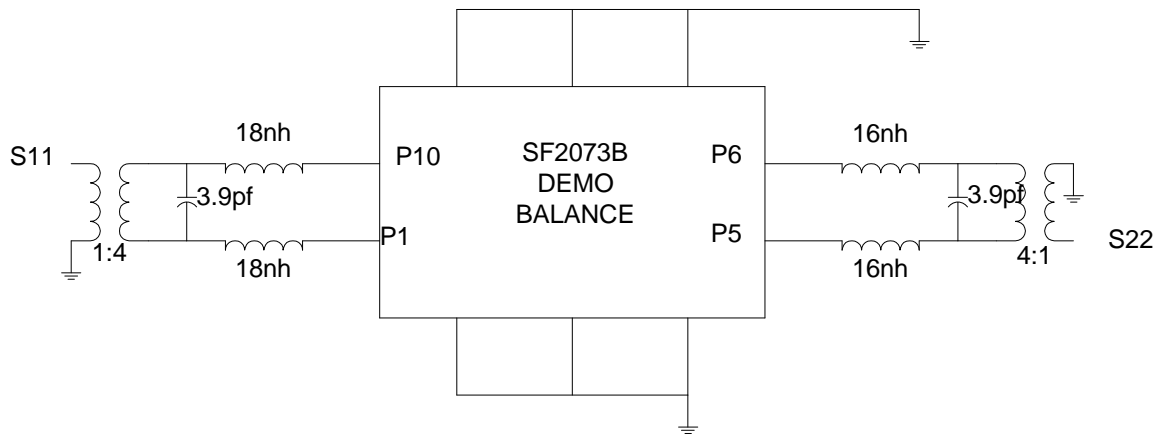

0603 coilcraft inductor

## I. Impedance Matching for Differential 200 Ohm Load: Coilcraft Inductors

(SAW Matched to 200 Ohms Balanced, 4:1 Transformers Account for 2dB of Loss)

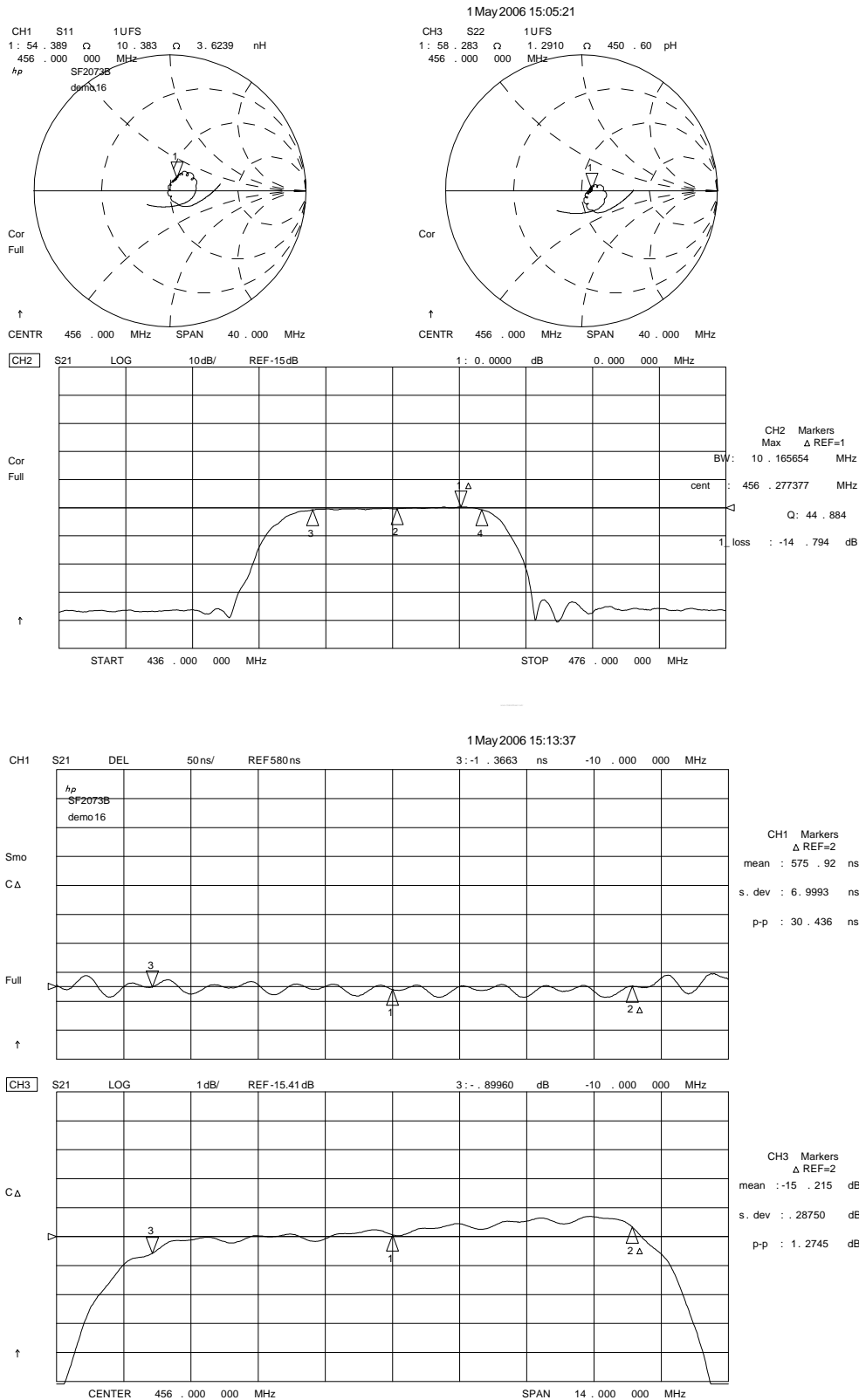

## II. Impedance Matching for Single Ended 50 Ohm load.

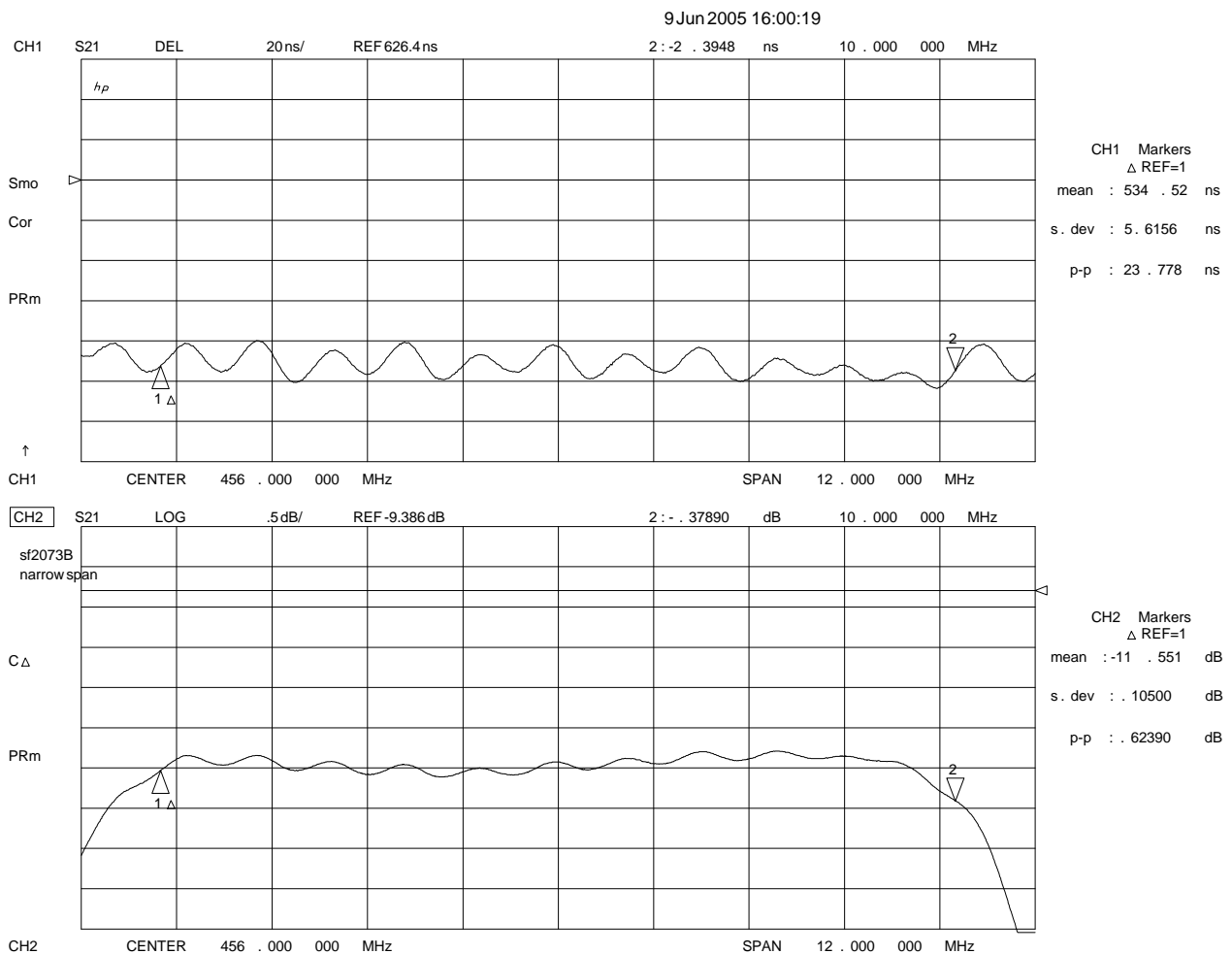
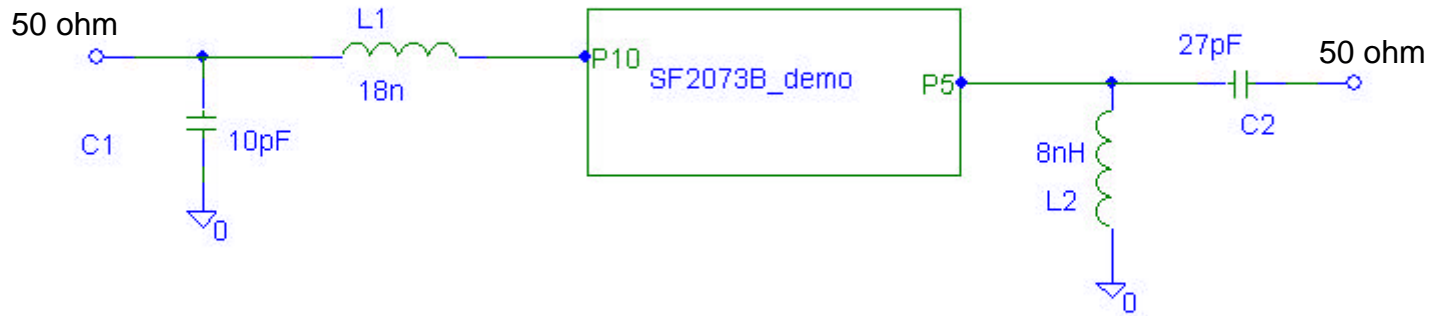

## II. Impedance Matching for Single Ended 50 Ohm load.

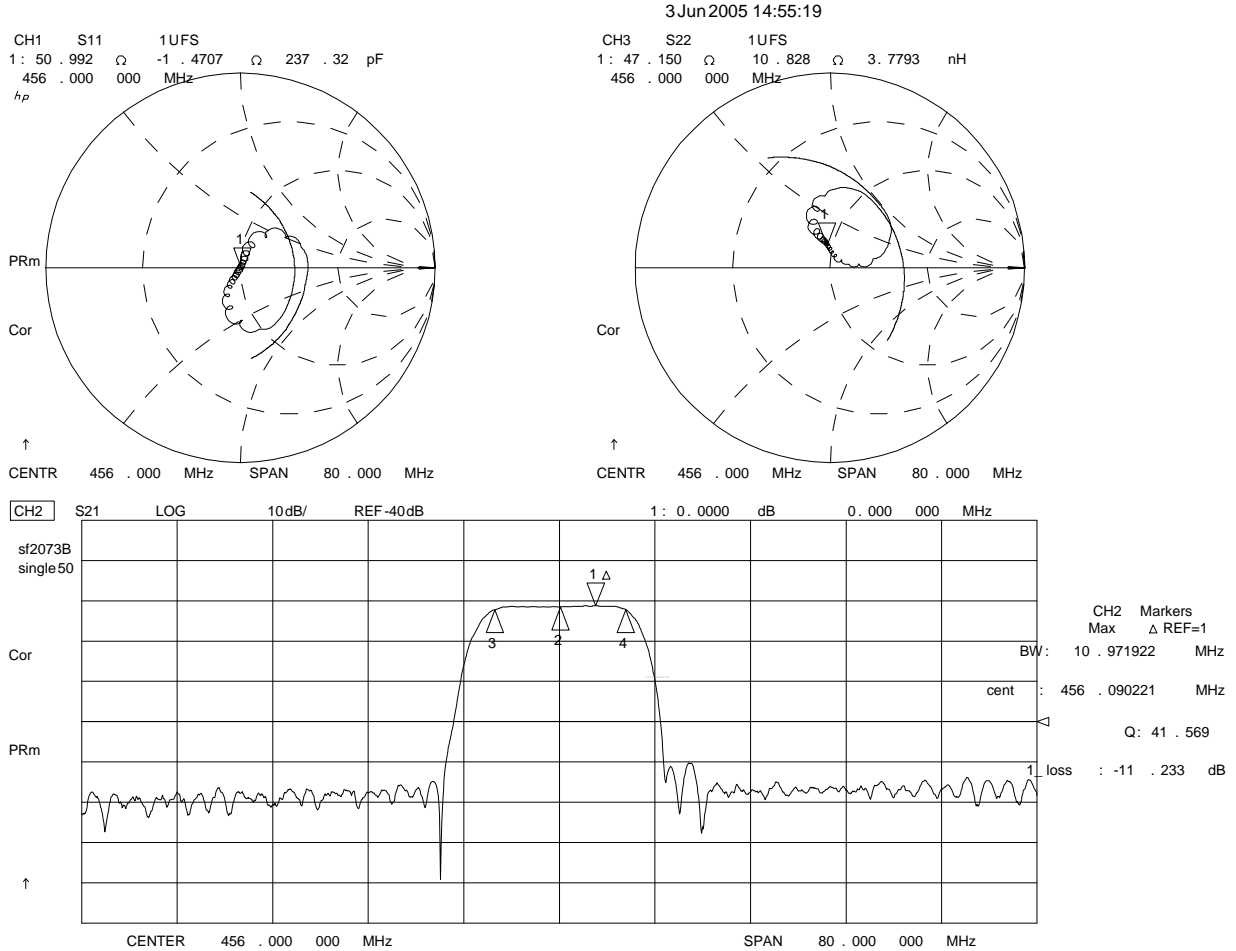

## III. Impedance Matching on SMI Radio Board: SMI 7035

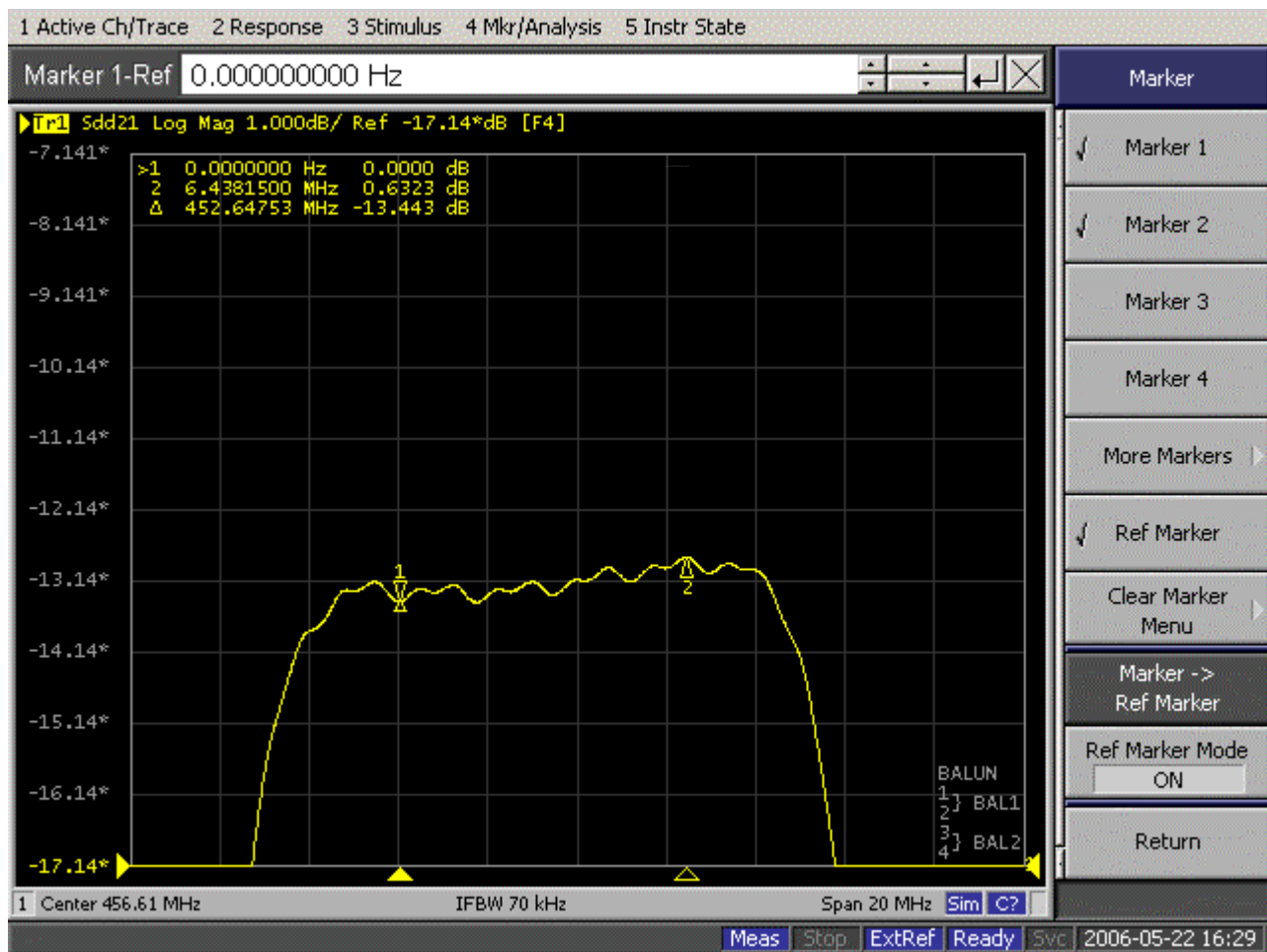
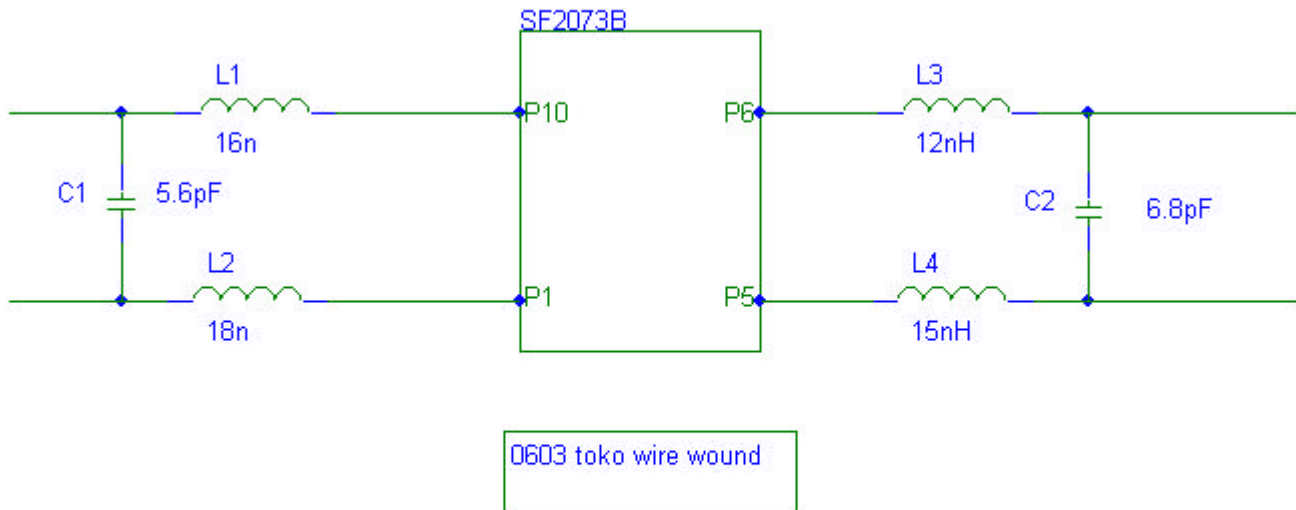

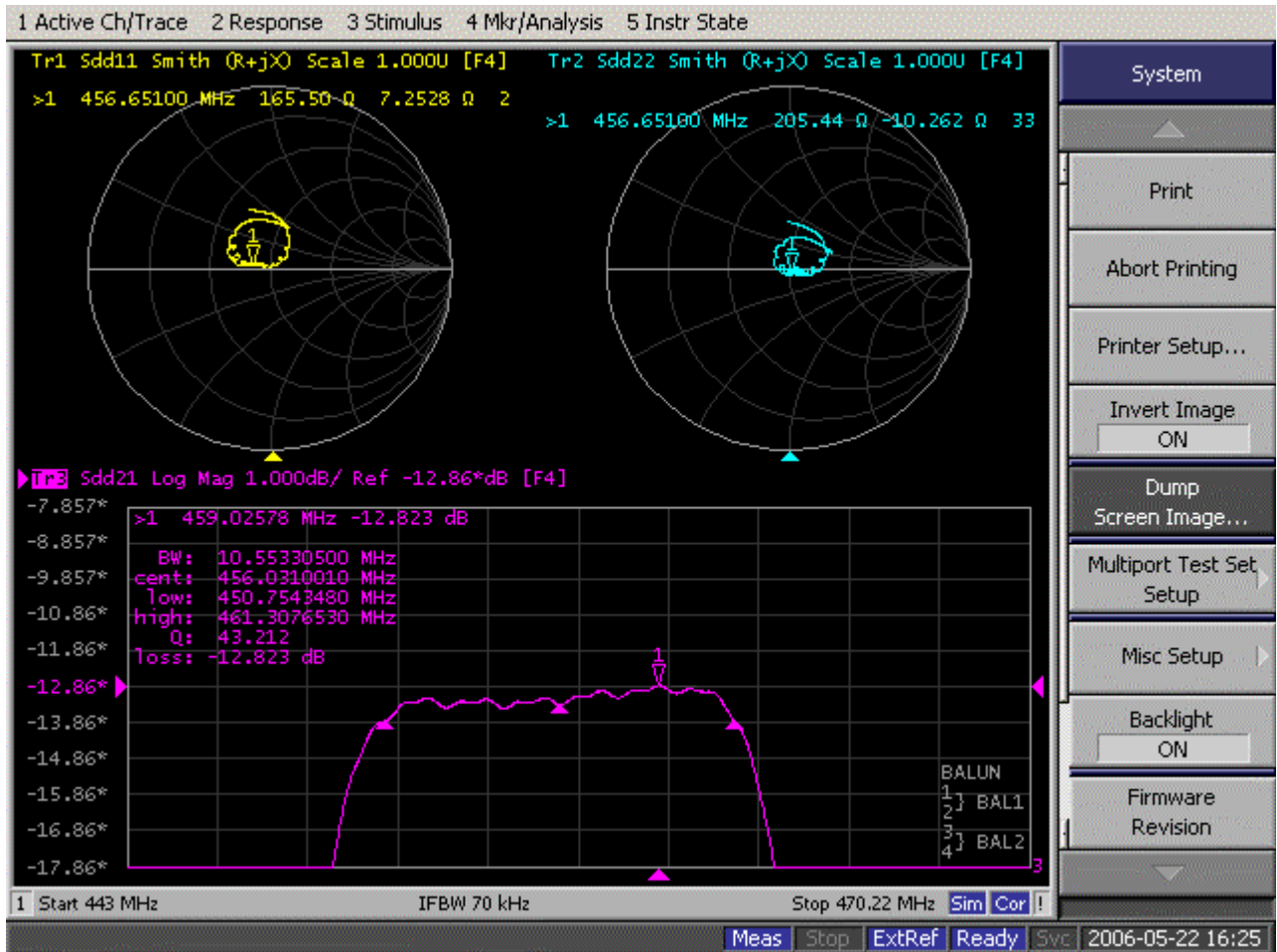

# SMP-03 Case

## 10-Terminal Ceramic Surface-Mount Case 7 x 5 mm Nominal Footprint

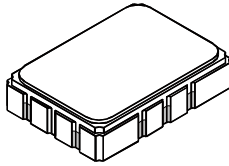

### Recommended PCB Footprint

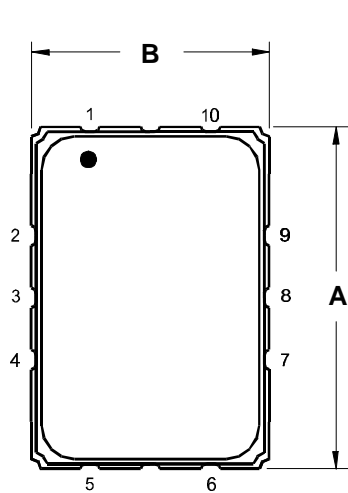
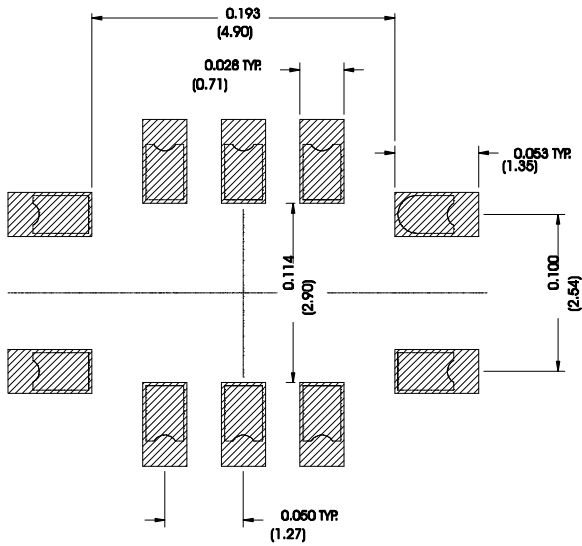

TOP VIEW

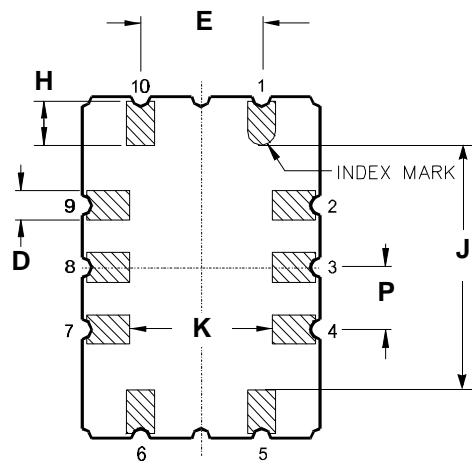
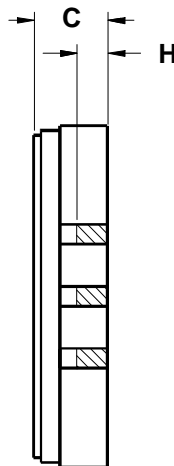

BOTTOM VIEW

Case Dimensions						
Dimension	mm			Inches		
	Min	Nom	Max	Min	Nom	Max
A	6.80	7.00	7.20	0.268	0.276	0.283
B	4.80	5.00	5.20	0.189	0.197	0.205
C	1.50	1.65	2.00	0.059	0.065	0.079
D	.47	0.60	.73	0.019	0.024	0.029
E	2.41	2.54	2.67	0.095	0.100	0.105
H	0.87	1.0	1.13	0.034	0.039	0.044
J	4.87	5.00	5.13	0.192	0.197	0.202
K	2.87	3.00	3.13	0.113	0.118	0.123
P	1.14	1.27	1.40	0.045	0.050	0.055

Materials	
Solder Pad Termination	Au plating 30 - 60 μinches (76.2-152 μm) over 80-200 μinches (203-508 μm) Ni.
Lid	Fe-Ni-Co Alloy Electroless Nickel Plate (8-11% Phosphorus) 100-200 μinches Thick
Body	Al <sub>2</sub> O <sub>3</sub> Ceramic
Pb Free	

Electrical Connections		
Connection		Terminals
Port 1	Input or Return	10
	Return or Input	1
Port 2	Output or Return	5
	Return or Output	6
Ground		All others
Single Ended Operation		Return is ground
Differential Operation		Return is hot



## Tape and Reel Specifications

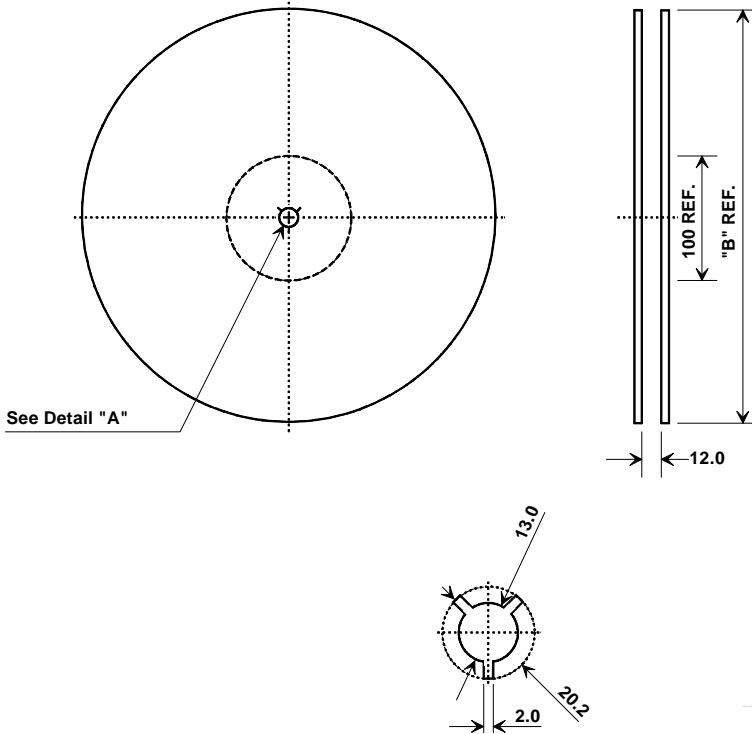

"B" Nominal Size		Quantity Per Reel
Inches	millimeters	
7	178	500
13	330	2000

## COMPONENT ORIENTATION and DIMENSIONS

Carrier Tape Dimensions		Tolerance
Ao	5.5 mm	± 0.1mm
Bo	7.5 mm	± 0.1mm
Ko	2.0 mm	± 0.1mm
Pitch	8.0 mm	± 0.1mm
W	16.0 mm	± 0.2mm

