

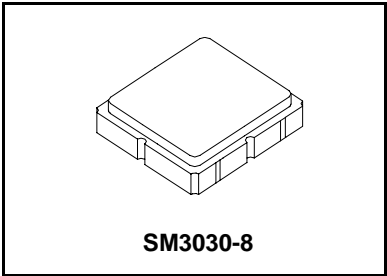

SF2093E

915.00 MHz SAW Filter



- Steep Roll-off Filter for 915 MHz ISM band
- Differential Input / Single-ended Output
- Complies with Directive 2002/95/EC (RoHS)



Absolute Maximum Ratings

| Rating | Value | Units |
|--|----------------|-------|
| Input Power Level | +15 | dBm |
| DC Voltage on any Non-ground Terminal | 3 | V |
| Operating Temperature Range | -30 to +85 | °C |
| Storage Temperature Range in Tape and Reel | -40 to +85 | °C |
| Suitable for Lead-free Soldering - Maximum Soldering Profile | 260°C for 30 s | |

Electrical Characteristics

| Characteristic | Sym | Notes | Min | Typ | Max | Units |
|---------------------------------------|-------|-------|-----|--------|-----|----------|
| Center Frequency | f_c | | | 915.00 | | MHz |
| Insertion Loss, 902 to 928 MHz | IL | | | 2.5 | 3.5 | dB |
| Amplitude Ripple, p-p, 902 to 928 MHz | | | | 0.5 | 2.0 | |
| VSWR, 902 to 928 MHz | | | | 1.75 | 2.4 | |
| Attenuation Referenced to 0 dB: | | | | | | |
| DC to 800 MHz | | | 40 | 54 | | |
| 850 to 870 MHz | | | 35 | 54 | | |
| 960 to 1035 MHz | | | 28 | 36 | | |
| 1035 to 1500 MHz | | | 40 | 57 | | |
| 1500 to 3000 MHz | | | 30 | 56 | | |
| Source Impedance | Z_s | | | 800 | | Ω |
| Load Impedance | Z_L | | | 50 | | Ω |

| | | | |
|--|---|------------------|--|
| Case Style | SM3030-8 3.0 x 3.0 mm Nominal Footprint | | |
| Lid Symbolization (Y=year, WW=week, S=shift) dot=pin 1 indicator | 582, YWWS | | |
| Standard Reel Quantity | Reel Size 7 Inch | 500 Pieces/Reel | |
| | Reel Size 13 Inch | 3000 Pieces/Reel | |

Electrical Connections

| Connection | Terminals |
|----------------------|------------|
| Input, Balanced | 1, 3 |
| Output, Single Ended | 6 |
| Case Ground | All others |



CAUTION: Electrostatic Sensitive Device. Observe precautions for handling.

Notes:

1. Unless noted otherwise, all specifications apply over the operating temperature range with filter soldered to the specified demonstration board with impedance matching to 50 Ω and measured with 50 Ω network analyzer.
2. Unless noted otherwise, all frequency specifications are referenced to the nominal center frequency, f_c .
3. Rejection is measured as attenuation below the minimum IL point in the passband. Rejection in final user application is dependent on PCB layout and external impedance matching design. See Application Note No. 42 for details.
4. The design, manufacturing process, and specifications of this filter are subject to change.
5. US and international patents may apply.
6. RFM, stylized RFM logo, and RF Monolithics, Inc. are registered trademarks of RF Monolithics, Inc.

SF2093E Filter Response Plots

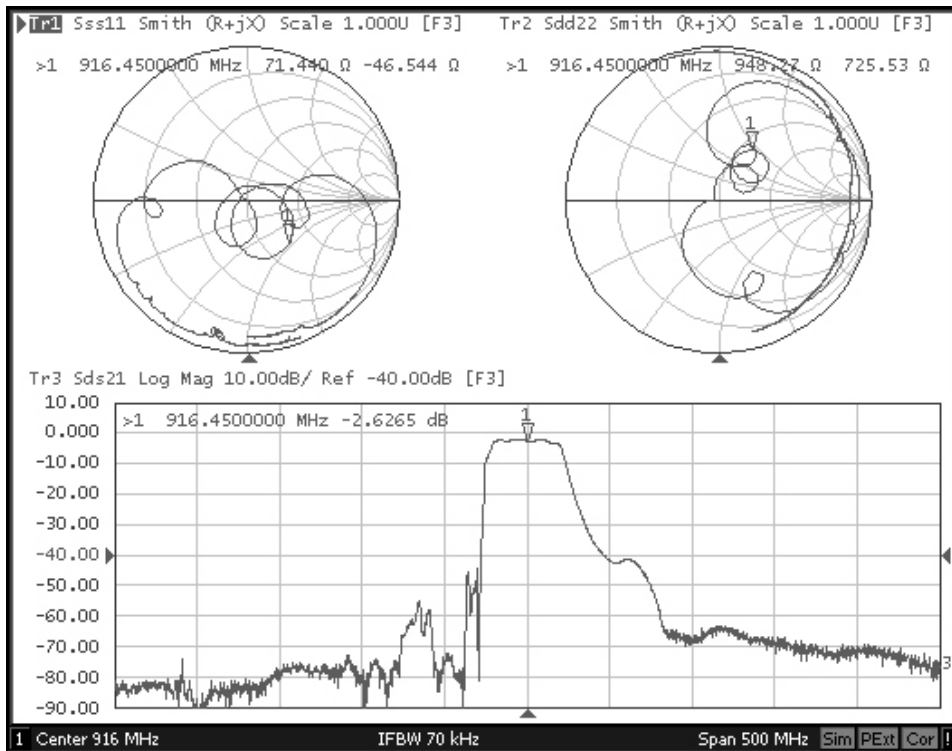

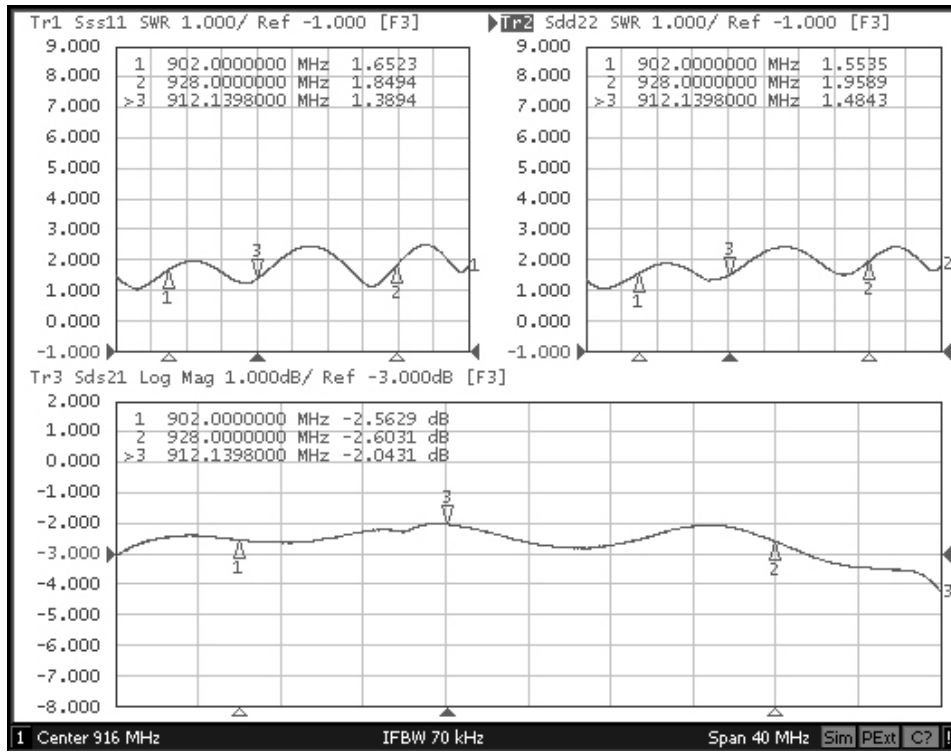

D. MEASUREMENT CIRCUIT:

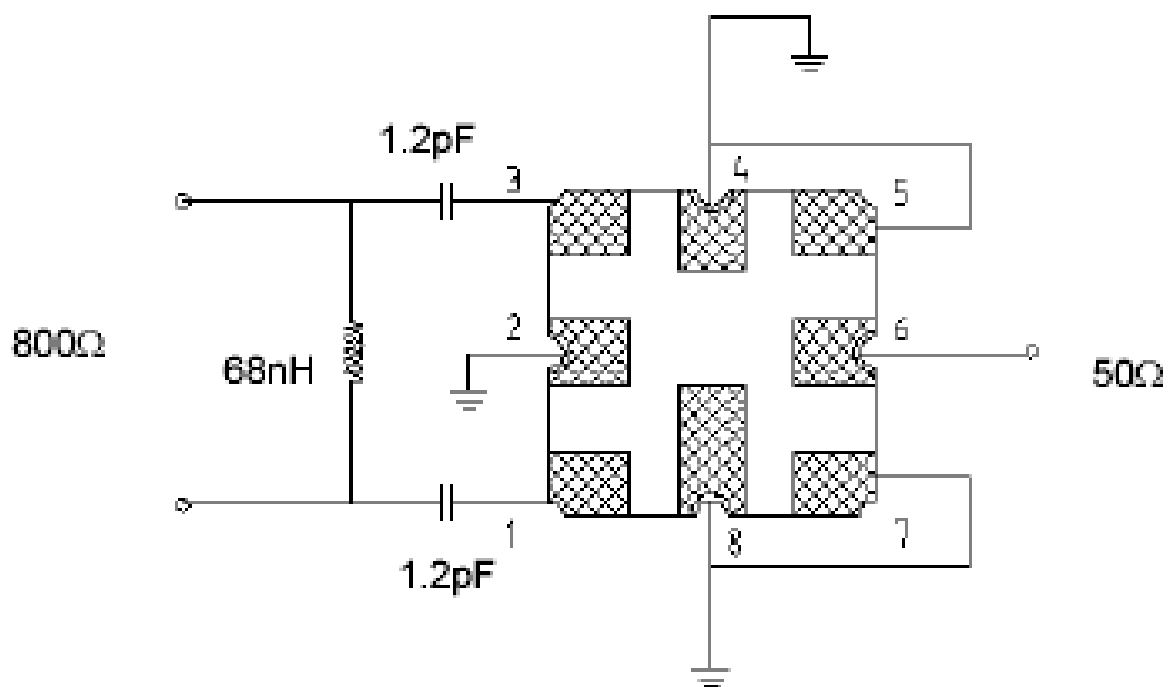

8-Terminal Ceramic Surface-Mount Case 3.0 X 3.0 mm Nominal Footprint

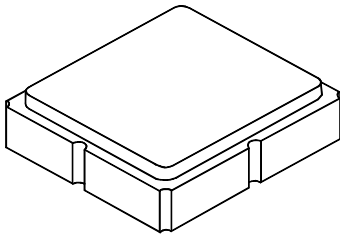

Case and PCB Footprint Dimensions

| Dimension | mm | | | Inches | | |
|-----------|------|------|------|--------|-------|-------|
| | Min | Nom | Max | Min | Nom | Max |
| A | 2.87 | 3.0 | 3.13 | 0.113 | 0.118 | 0.123 |
| B | 2.87 | 3.0 | 3.13 | 0.113 | 0.118 | 0.123 |
| C | 1.14 | 1.27 | 1.40 | 0.045 | 0.050 | 0.055 |
| D | 0.79 | 0.92 | 1.05 | 0.031 | 0.036 | 0.041 |
| E | 0.62 | 0.75 | 0.88 | 0.024 | 0.029 | 0.034 |
| F | 0.47 | 0.60 | 0.73 | 0.018 | 0.024 | 0.029 |
| G | 0.47 | 0.60 | 0.73 | 0.018 | 0.024 | 0.029 |
| H | 1.07 | 1.20 | 1.33 | 0.042 | 0.047 | 0.052 |
| I | | 3.19 | | | 0.126 | |
| J | | 0.81 | | | 0.032 | |
| K | | 0.96 | | | 0.038 | |
| L | | 0.81 | | | 0.032 | |
| M | | 1.39 | | | 0.055 | |
| N | | 0.23 | | | 0.009 | |
| O | | 0.38 | | | 0.015 | |

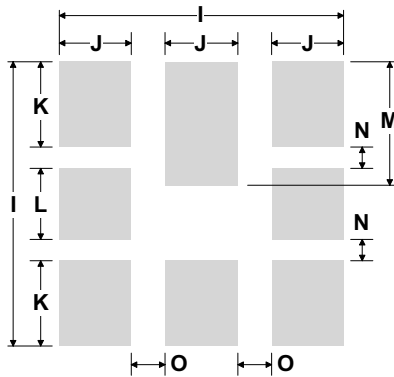

PCB Footprint Top View

Case Materials

| Materials | |
|--------------------|--|
| Solder Pad Plating | 0.3 to 1.0 μm Gold over 1.27 to 8.89 μm Nickel |
| Lid Plating | 2.0 to 3.0 μm Nickel |
| Body | Al_2O_3 Ceramic |
| | Pb Free |

TOP VIEW

BOTTOM VIEW

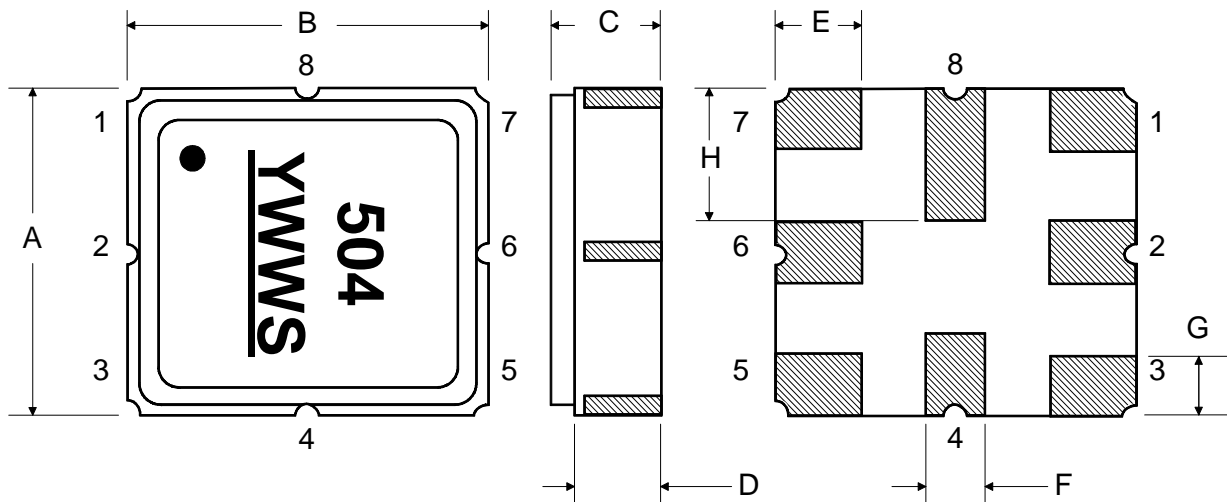

Tape and Reel Specifications

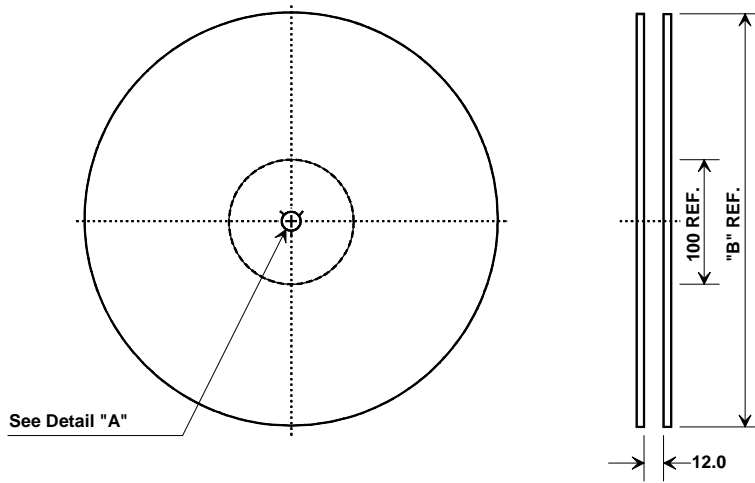

| "B" | | Quantity Per Reel |
|--------|-------------|-------------------|
| Inches | millimeters | |
| 7 | 178 | 500 |
| 13 | 330 | 3000 |

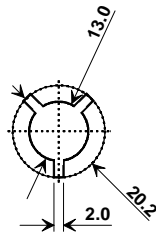

| Carrier Tape Dimensions | |
|-------------------------|---------|
| Ao | 3.35 mm |
| Bo | 3.35 mm |
| Ko | 1.40 mm |
| Pitch | 8.0 mm |
| W | 12.0 mm |

COMPONENT ORIENTATION and DIMENSIONS

