

Preliminary

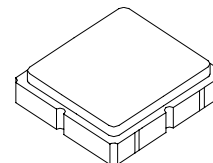

SF2139D

**177.0 MHz
SAW Filter**



SM3838-6

- **Low Insertion Loss**
- **3.8 X 3.8 X 1.0 mm Surface Mount Case**
- **Complies with Directive 2002/95/EC (RoHS)**



Absolute Maximum Ratings

Rating	Value	Units
Maximum Incident Power in Passband	+10	dBm
Maximum DC Voltage Between any Two Terminals	30	VDC
Storage Temperature Range in Tape and Reel	-40 to +85	°C
Suitable for Lead-free Soldering - Maximum Soldering Profile	260 °C for 30 s	

Electrical Characteristics

Characteristic	Sym	Notes	Min	Typ	Max	Units
Center Frequency	f_c	1		177		MHz
Source Impedance, Single Ended				50		Ω
Load Impedance, Single Ended				50		Ω
1 dB Bandwidth	BW_1		20	23.8		MHz
40 dB Bandwidth	BW_{40}			40	60	MHz
Template on the Amplitude, Reference is Minimum IL						dB
10 to 149 MHz			38	40		
209 to 350 MHz			37	39		
Maximum Insertion Loss	IL_{MAX}			7.0	9.0	dB
Amplitude Variation over 20 MHz Passband				1.1	1.5	dB _{p-p}
Group Delay Variation over 20 MHz Passband				15	80	nsp-p
Absolute Group Delay at f_c				0.308		μ s
Input/Output Return loss over 20 MHz Passband			5	7		dB
Operating Temperature			-40		+85	°C

Case Style	SM3838-6 3.8 x 3.8 mm Nominal Footprint		
Lid Symbolization (Y=year, WW=week, S=shift) dot=pin 1 indicator	TBD, YWWS		
Standard Reel Quantity	Reel Size 7 Inch	1000 Pieces/Reel	
	Reel Size 13 Inch	3000 Pieces/Reel	



CAUTION: Electrostatic Sensitive Device. Observe precautions for handling.

Notes:

1. Unless noted otherwise, all specifications apply over the operating temperature range with filter soldered to the specified demonstration board with impedance matching to 50 Ω and measured with 50 Ω network analyzer.
2. Unless noted otherwise, all frequency specifications are referenced to the nominal center frequency, f_c .
3. Rejection is measured as attenuation below the minimum IL point in the passband. Rejection in final user application is dependent on PCB layout and external impedance matching design. See Application Note No. 42 for details.
4. The design, manufacturing process, and specifications of this filter are subject to change.
5. Either Port 1 or Port 2 may be used for either input or output in the design. However, impedances and impedance matching may vary between Port 1 and Port 2, so that the filter must always be installed in one direction per the circuit design.
6. US and international patents may apply.
7. RFM, stylized RFM logo, and RF Monolithics, Inc. are registered trademarks of RF Monolithics, Inc.

6 Mar 2009 11:18:17

CH1 S11 1 UFS
1: 26.826 \cap -3.6221 \cap 248.25 pF
177.000 000 MHz
SF2139D BIAS+0.5UM'S

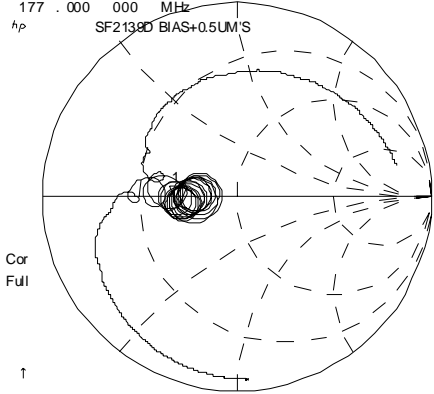

CENTR 177.000 MHz SPAN 100.000 MHz

CH3 S22 1 UFS
1: 27.332 \cap -10.479 \cap 85.804 pF
177.000 000 MHz

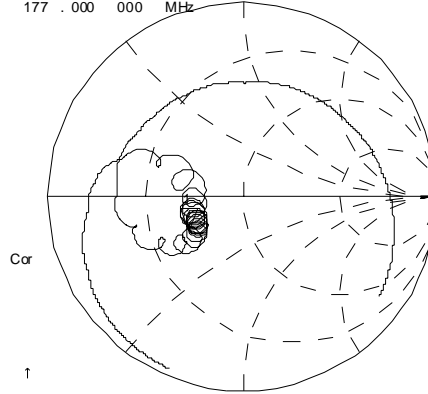

CENTR 177.000 MHz SPAN 100.000 MHz

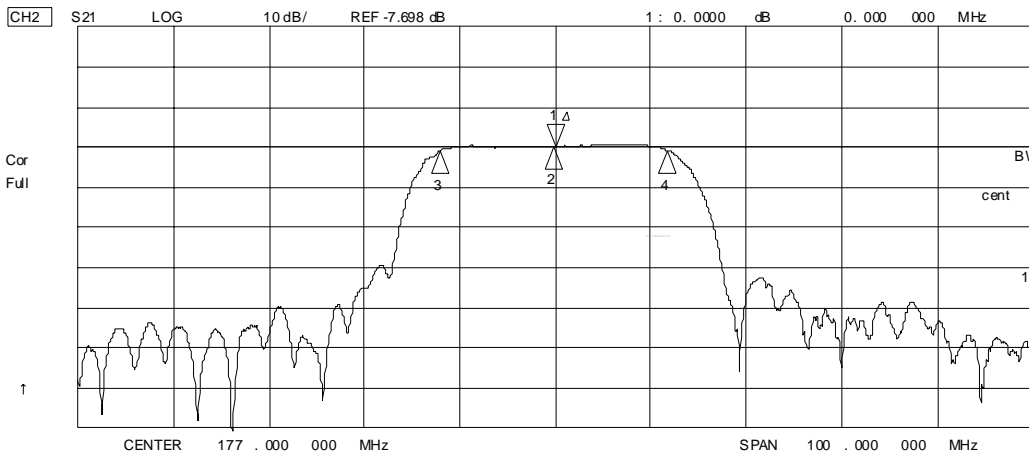

6 Mar 2009 11:20:18

CH1 LOG 10 dB/ REF 0 dB
S11 3 :-9 .1614 dB 187 .000 000 MHz

CHB LOG 10 dB/ REF 0 dB
S22 3 :-7 .3876 dB 187 .000 000 MHz

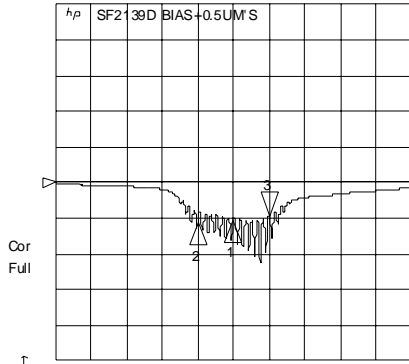

CH1 Markers
1 : -10 .318 dB
177 .000 MHz
2 : -11 .047 dB
167 .000 MHz

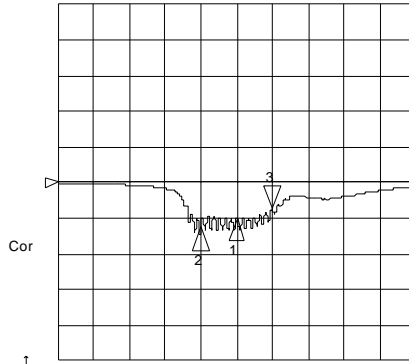

CH3 Markers
1 : -9 .8974 dB
177 .000 MHz
2 : -12 .421 dB
167 .000 MHz

CENTR 177 .000 MHz SPAN 100 .000 MHz

CENTR 177 .000 MHz SPAN 100 .000 MHz

CH2 S21 LOG 10 dB/ REF -7.698 dB 1: 0.000 dB 0.000 000 MHz

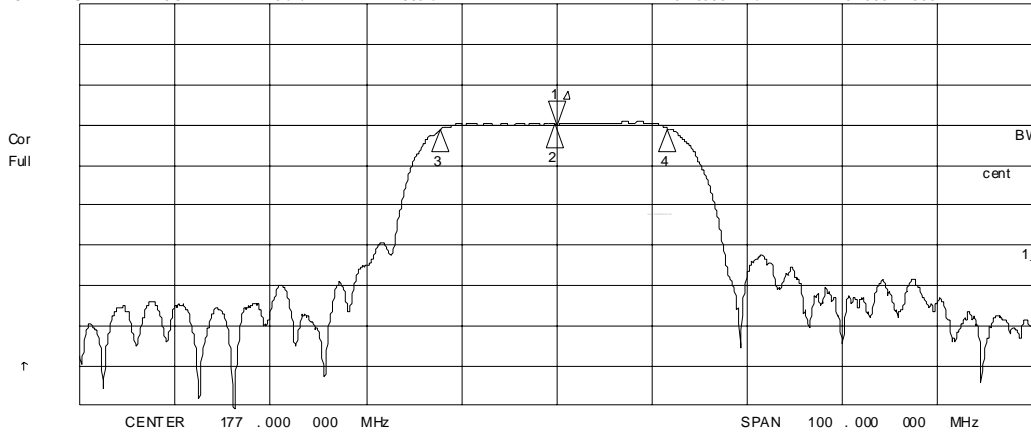

CH2 Markers
Δ REF=1
BW: 23 .827048 MHz
cent : 176 .778625 MHz
Q: 7 .4192
1 loss : -7 .7004 dB

CENTR 177 .000 000 MHz SPAN 100 .000 000 MHz

6 Mar 2009 11:31:25

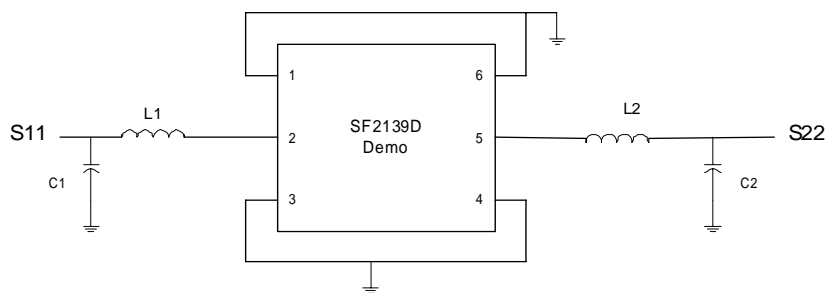
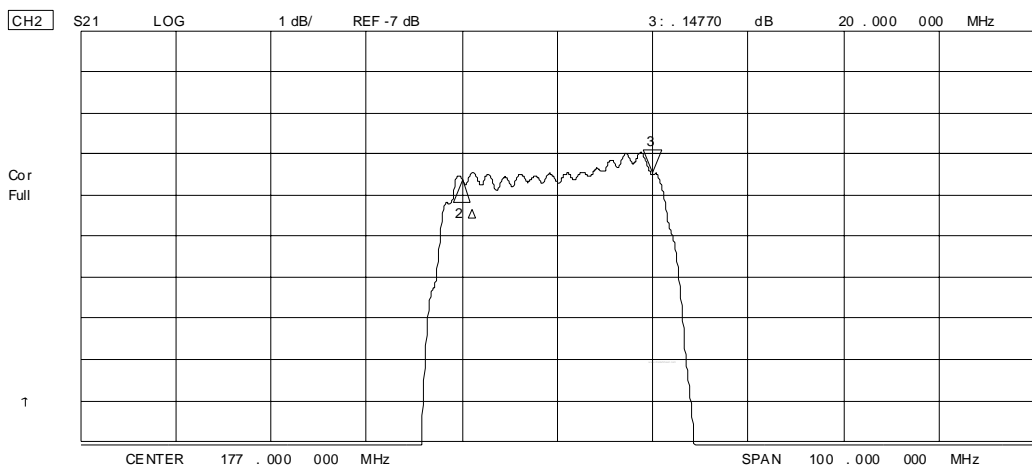
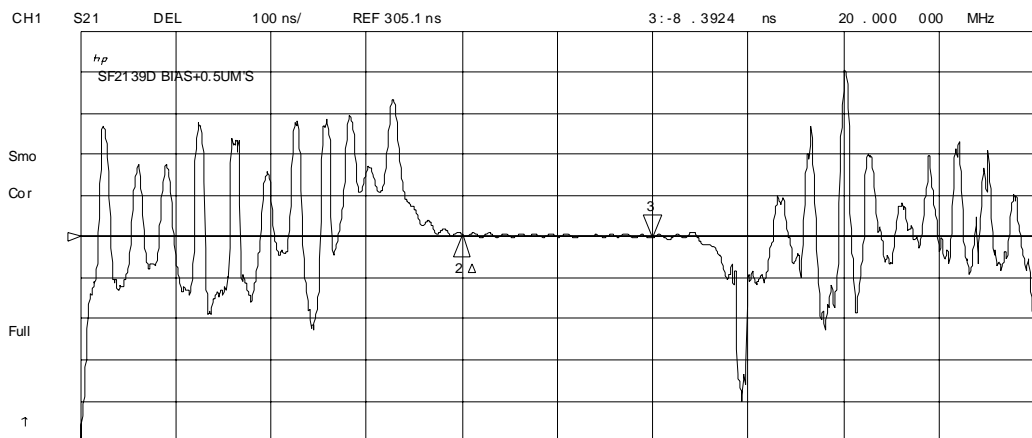

- PCB: 401-1720-002
- L1: 501-0782-121 0805CS, 120 nH
- L2: 501-0782-101 0805CS, 100 nH
- C1: 500-1275-068 0805CS, 6.8 pF
- C2: 500-1275-150 0805CS, 15 pF

Tape and Reel Specifications

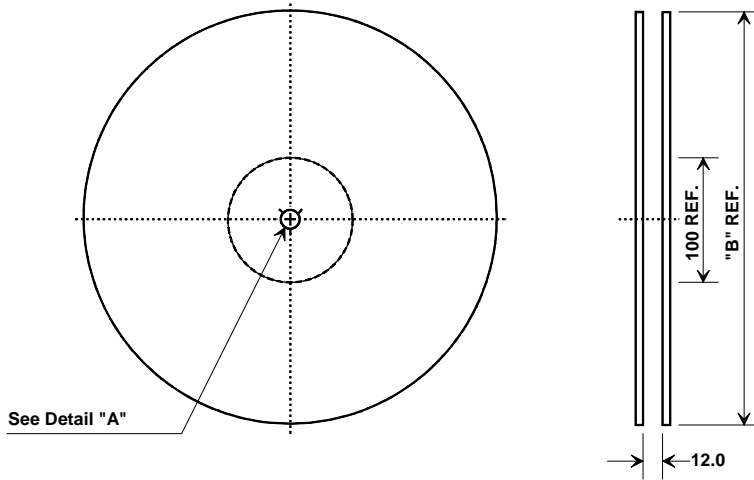

"B"		Quantity Per Reel
Inches	millimeters	
7	178	1000
13	330	3000

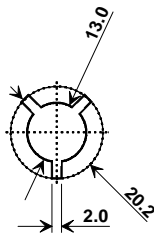

COMPONENT ORIENTATION and DIMENSIONS

Carrier Tape Dimensions	
Ao	4.25 mm
Bo	4.25 mm
Ko	1.30 mm
Pitch	8.0 mm
W	12.0 mm

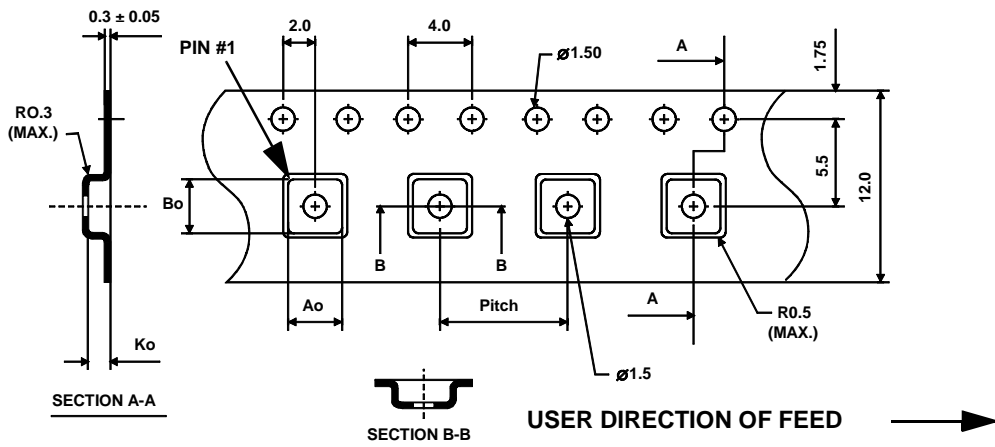

SM3838-6 Case

6-Terminal Ceramic Surface-Mount Case 3.8 X 3.8 mm Nominal Footprint

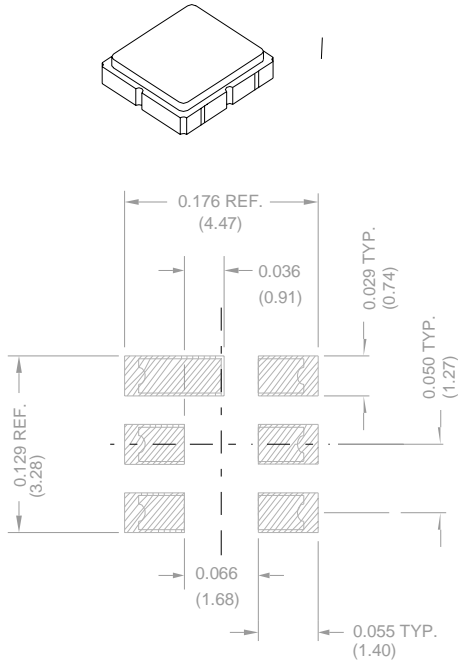

PCB Footprint

Case Dimensions						
Dimension	mm			Inches		
	Min	Nom	Max	Min	Nom	Max
A	3.60	3.80	4.0	0.14	0.15	0.16
B	3.60	3.80	4.0	0.14	0.15	0.16
C	1.30	1.50	1.70	0.05	0.06	0.067
D	0.95	1.10	1.25	0.037	0.043	0.05
E	2.39	2.54	2.69	0.090	0.10	0.110
G	0.90	1.0	1.10	0.035	0.04	0.043
H	1.90	2.0	2.10	0.75	0.08	0.83
I	0.50	0.6	0.70	0.020	0.024	0.028
J	1.70	1.8	1.90	0.067	0.07	0.075

Electrical Connections		
Connection	Terminals	
Port 1	Single-ended Input	2
Port 2	Single-ended Output	5
	Ground	All others
Single-ended Operation Only		
Dot indicates Pin 1		

Materials	
Solder Pad Plating	0.3 to 1.0 μm Gold over 1.27 to 8.89 μm Nickel
Lid Plating	2.0 to 3.0 μm Nickel
Body	Al_2O_3 Ceramic
Pb Free	

TOP VIEW

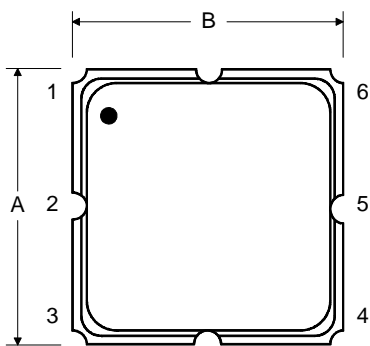

BOTTOM VIEW

