

TOSHIBA THYRISTOR SILICON PLANAR TYPE

# SF25GZ51, SF25JZ51

## MEDIUM POWER CONTROL APPLICATIONS

- Repetitive Peak Off-State Voltage :  $V_{DRM} = 400, 600 \text{ V}$   
 Repetitive Peak Reverse Voltage :  $V_{RRM} = 400, 600 \text{ V}$
- Average On-State Current :  $I_T (AV) = 25 \text{ A}$
- Isolation Voltage :  $V_{Isol} = 1500 \text{ V AC}$

## MAXIMUM RATINGS

CHARACTERISTIC	SYMBOL	RATING	UNIT
Repetitive Peak Off-State Voltage and Repetitive Peak Reverse Voltage	SF25GZ51	400	V
	SF25JZ51	600	
Non-Repetitive Peak Reverse Voltage (Non-Repetitive < 5 ms, $T_j = 0\sim 125^\circ\text{C}$ )	SF25GZ51	500	V
	SF25JZ51	720	
Average On-State Current (Half Sine Waveform)	$I_T (AV)$	25	A
R.M.S On-State Current	$I_T (RMS)$	39	A
Peak One Cycle Surge On-State Current (Non-Repetitive)	$I_{TSM}$	350 (50 Hz)	A
		385 (60 Hz)	
$I^2t$ Limit Value	$I^2t$	612	$\text{A}^2\text{s}$
Critical Rate of Rise of On-State Current (Note)	$di / dt$	100	$\text{A} / \mu\text{s}$
Peak Gate Power Dissipation	$P_{GM}$	5	W
Average Gate Power Dissipation	$P_G (AV)$	0.5	W
Peak Forward Gate Voltage	$V_{FGM}$	10	V
Peak Reverse Gate Voltage	$V_{RGM}$	-5	V
Peak Forward Gate Current	$I_{GM}$	2	A
Junction Temperature	$T_j$	-40~125	$^\circ\text{C}$
Storage Temperature Range	$T_{stg}$	-40~125	$^\circ\text{C}$
Isolation Voltage (AC, $t = 1 \text{ min.}$ )	$V_{Isol}$	1500	V

Note :  $di / dt$  Test Condition,  $I_G = 30\text{mA}$ ,  $t_{GW} = 10\mu\text{s}$ ,  $t_{GR} \leq 250\text{ns}$

Unit in mm

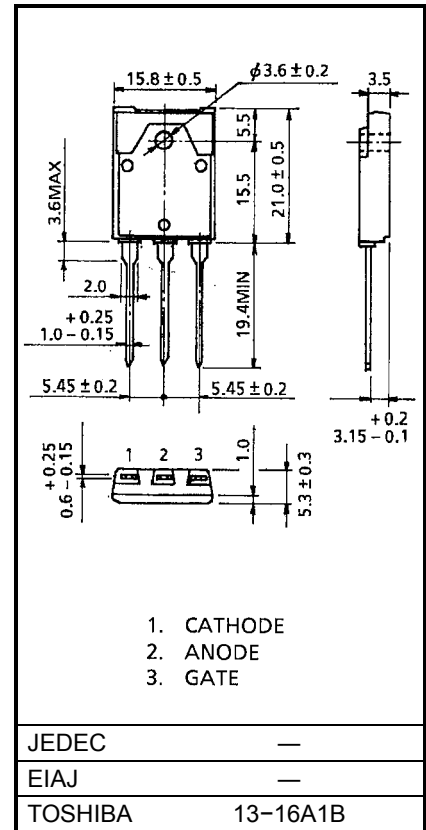

Weight : 5.9g

## ELECTRICAL CHARACTERISTICS (Ta = 25°C)

CHARACTERISTIC	SYMBOL	TEST CONDITION	MIN.	TYP.	MAX.	UNIT
Repetitive Peak Off-State Current and Repetitive Peak Reverse Current	$I_{DRM}$ $I_{RRM}$	$V_{DRM} = V_{RRM} = \text{Rated}$	—	—	20	$\mu\text{A}$
Peak On-State Voltage	$V_{TM}$	$I_{TM} = 80 \text{ A}$	—	—	1.5	V
Gate Trigger Voltage	$V_{GT}$	$V_D = 6 \text{ V}, R_L = 10 \Omega$	—	—	1.5	V
Gate Trigger Current	$I_{GT}$		—	—	20	mA
Holding Current	$I_H$	$V_D = 6 \text{ V}, I_{TM} = 500 \text{ mA}$	—	—	100	mA
Critical Rate of Rise of Off-State Voltage	$dv / dt$	$V_{DRM} = \text{Rated}, T_c = 125^\circ\text{C}$ Exponential Rise	—	50	—	$\text{V} / \mu\text{s}$
Thermal Resistance	$R_{th(j-c)}$	Junction to Case	—	—	1.3	$^\circ\text{C} / \text{W}$

## MARKING

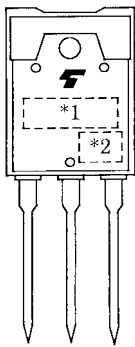

NUMBER	SYMBOL	MARK
*1	TYPE	SF25GZ51
		SF25JZ51
*2	Lot Number  Month (Starting from ) (Alphabet A ) Year (Last Decimal Digit of ) (the Year of Manufacture )	Example 8A : January 1998 8B : February 1998 8L : December 1998

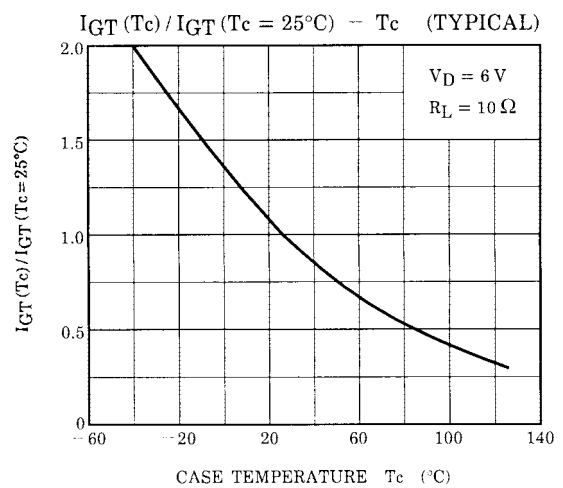
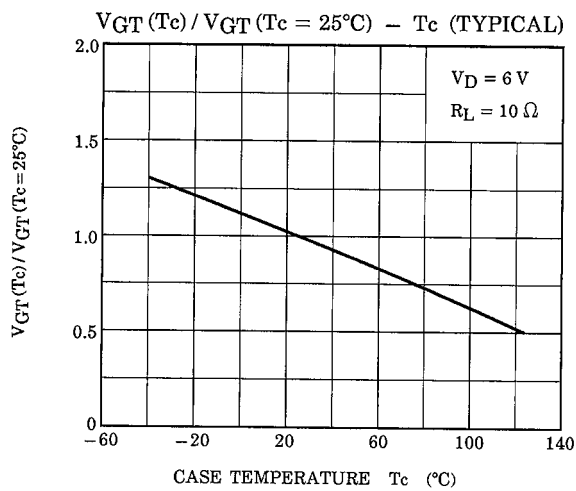
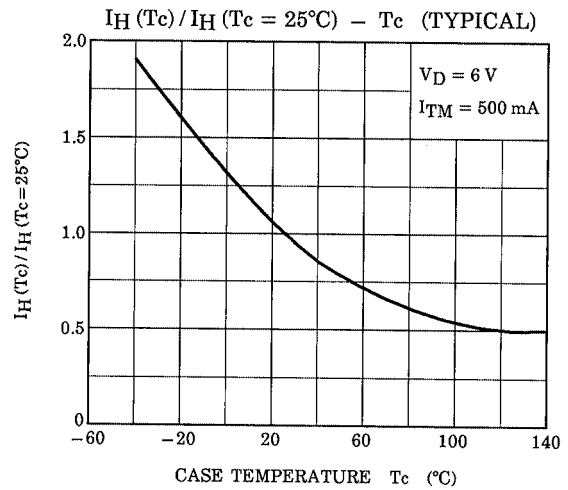
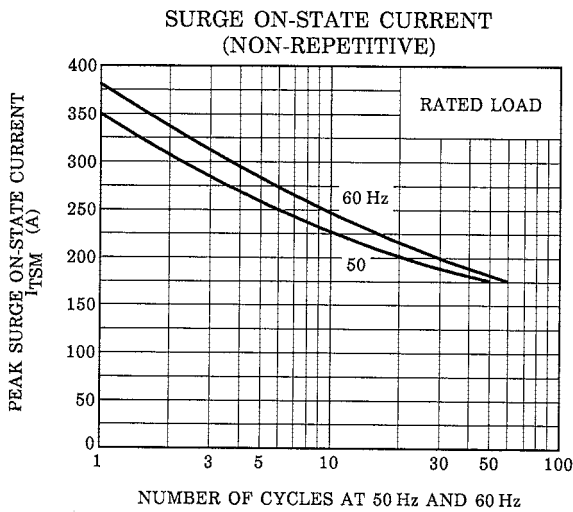
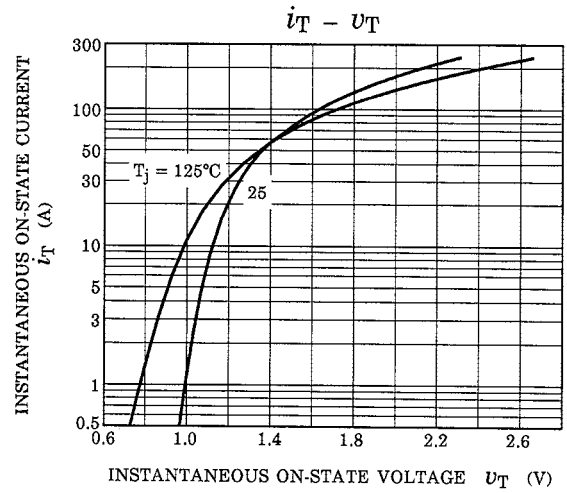
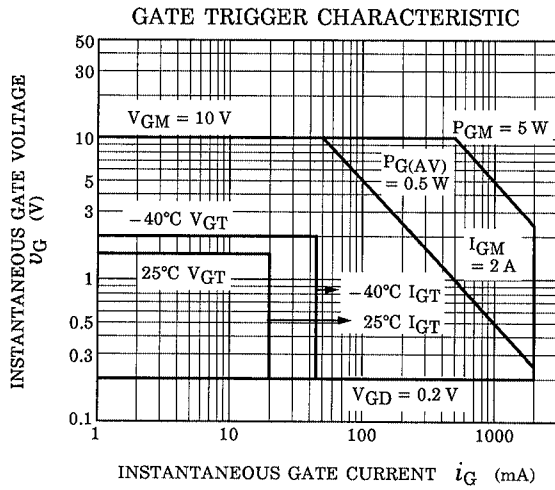

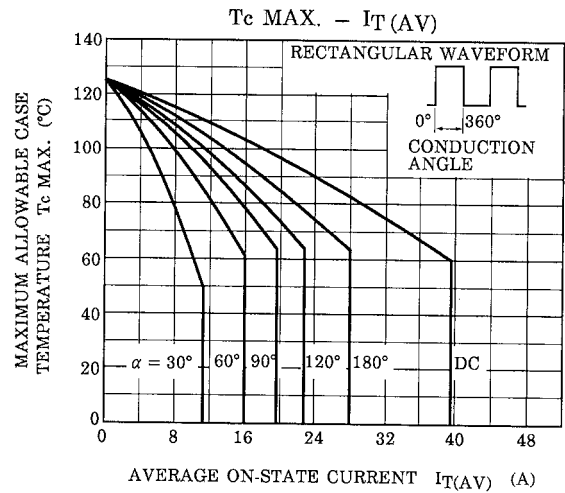
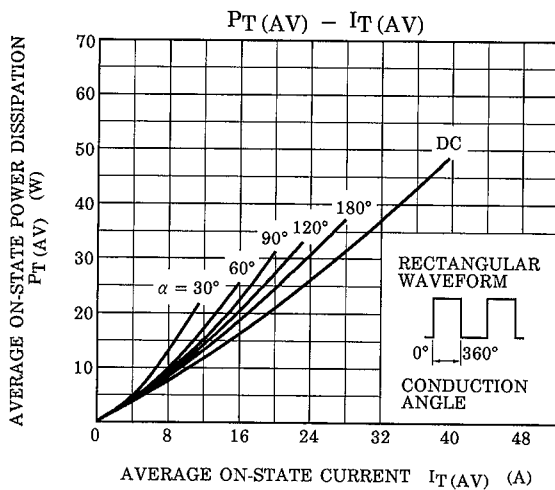
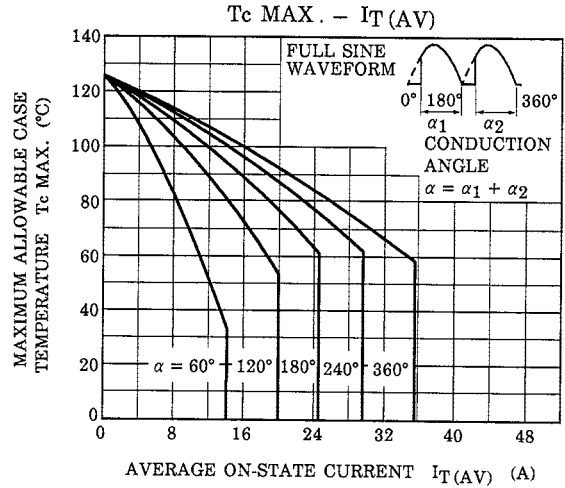
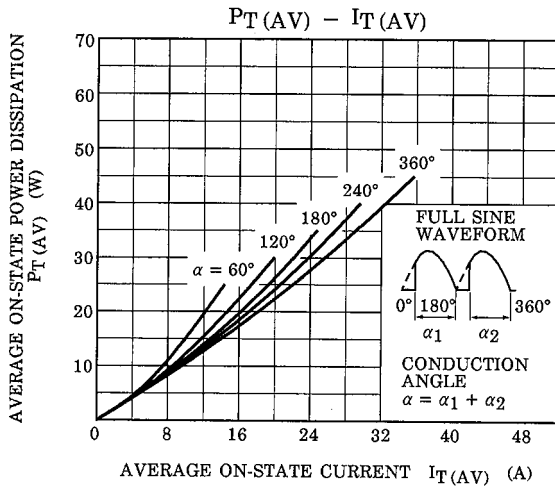
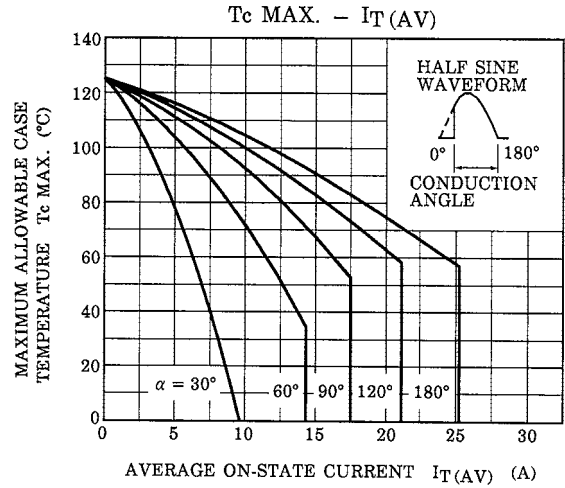
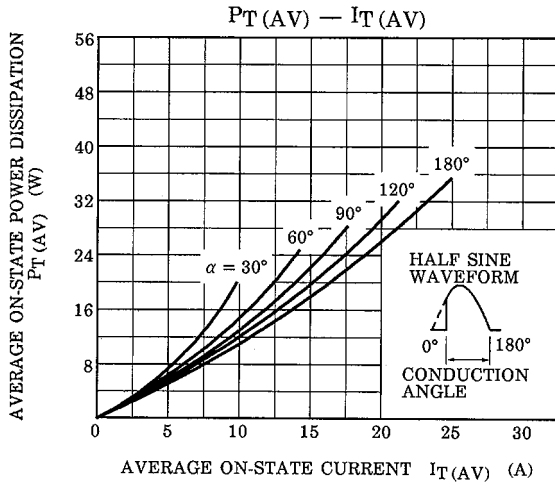

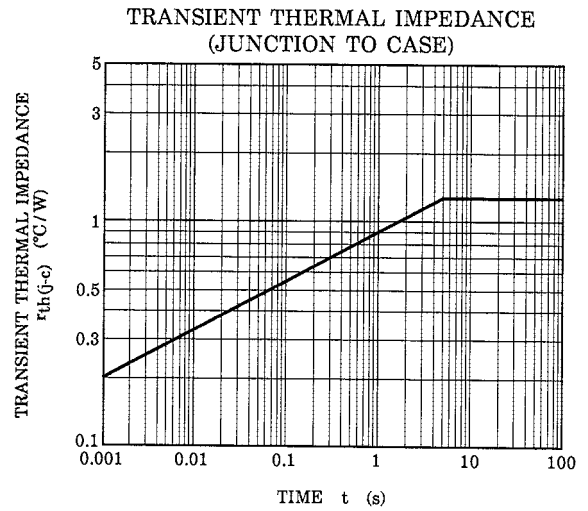
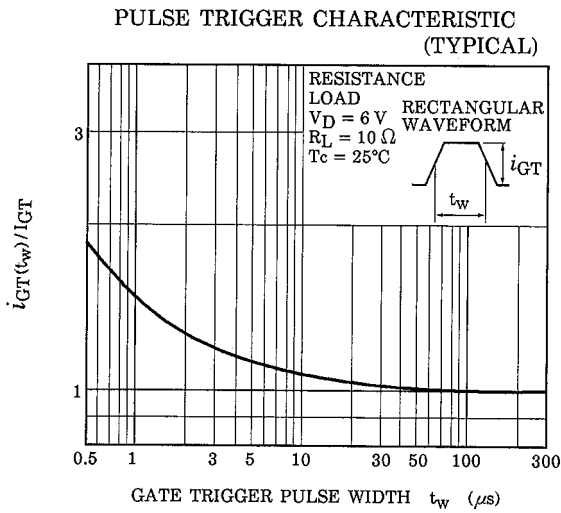
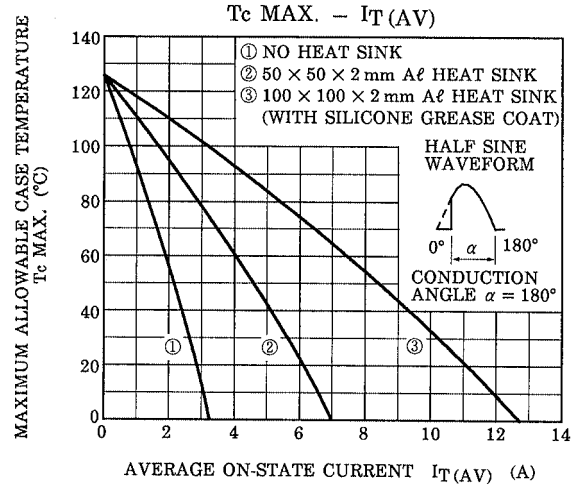
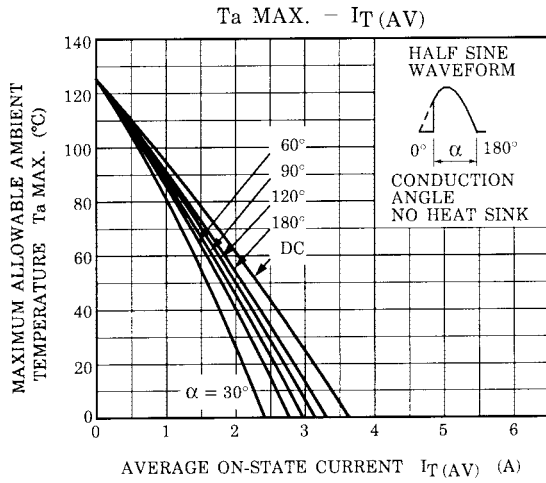

**RESTRICTIONS ON PRODUCT USE**

000707EAA

- TOSHIBA is continually working to improve the quality and reliability of its products. Nevertheless, semiconductor devices in general can malfunction or fail due to their inherent electrical sensitivity and vulnerability to physical stress. It is the responsibility of the buyer, when utilizing TOSHIBA products, to comply with the standards of safety in making a safe design for the entire system, and to avoid situations in which a malfunction or failure of such TOSHIBA products could cause loss of human life, bodily injury or damage to property.  
In developing your designs, please ensure that TOSHIBA products are used within specified operating ranges as set forth in the most recent TOSHIBA products specifications. Also, please keep in mind the precautions and conditions set forth in the "Handling Guide for Semiconductor Devices," or "TOSHIBA Semiconductor Reliability Handbook" etc..
- The TOSHIBA products listed in this document are intended for usage in general electronics applications (computer, personal equipment, office equipment, measuring equipment, industrial robotics, domestic appliances, etc.). These TOSHIBA products are neither intended nor warranted for usage in equipment that requires extraordinarily high quality and/or reliability or a malfunction or failure of which may cause loss of human life or bodily injury ("Unintended Usage"). Unintended Usage include atomic energy control instruments, airplane or spaceship instruments, transportation instruments, traffic signal instruments, combustion control instruments, medical instruments, all types of safety devices, etc.. Unintended Usage of TOSHIBA products listed in this document shall be made at the customer's own risk.
- The information contained herein is presented only as a guide for the applications of our products. No responsibility is assumed by TOSHIBA CORPORATION for any infringements of intellectual property or other rights of the third parties which may result from its use. No license is granted by implication or otherwise under any intellectual property or other rights of TOSHIBA CORPORATION or others.
- The information contained herein is subject to change without notice.