



**SF31G thru SF38G**

**3.0A Glass Passivated Leaded Super Fast Rectifiers - 50V- 600V**



**FEATURES**

- Low reverse leakage current
- Low forward drop down voltage & high current capability
- High surge current capability
- Super fast switching speed for high efficiency
- Glass passivated chip junction
- High Reliability
- Lead-free parts for green partner, meet RoHS requirements

**MECHANICAL DATA**

- Case: JEDEC DO-201AD molded plastic
- Epoxy: UL94-V0 rated flame retardant
- Terminals: Solderable per MIL-STD-750 Method 2026
- Polarity: Color band denotes cathode end
- Mounting Position: Any
- Weight: 0.04 ounces, 1.1 grams

**DO-201AD**

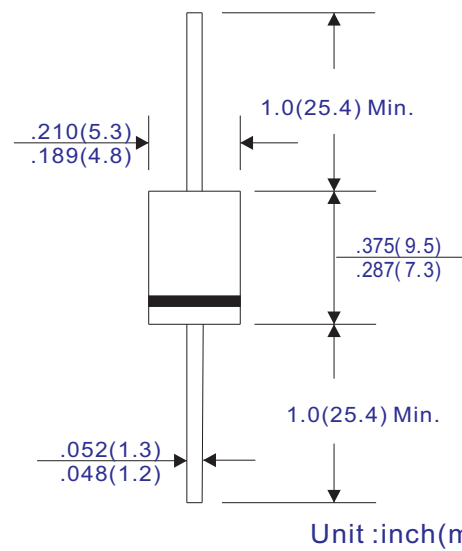

**MAXIMUM RATING AND ELECTRICAL CHARACTERISTICS**  
 Ratings at 25°C ambient temperature unless otherwise specified

	Symbols	SF31G	SF32G	SF33G	SF34G	SF35G	SF36G	SF37G	SF38G	Units
Maximum Recurrent Peak Reverse Voltage	VRRM	50	100	150	200	300	400	500	600	Volts
Maximum RMS Voltage	VRMS	35	70	105	140	210	280	350	420	Volts
Maximum DC Blocking Voltage	VDC	50	100	150	200	300	400	500	600	Volts
Maximum Average Forward Rectified Current .375" (9.5mm) lead length @TA=75°C, See Figure 1	I(AV)	3.0								Amps
Peak Forward Surge Current 8.3mS single half sine-wave superimposed on rated load (JEDEC Method)	IFSM	125								Amps
Maximum Instantaneous Forward Voltage at 3.0A	VF	0.95			1.25		1.5			Volts
Maximum DC Reverse Current at Rated DC Blocking Voltage TA= 25°C TA=125°C	IR	5.0 50.0								µA
Maximum Reverse Recovery Time (Note 1)	Trr	35						50		nS
Typical Junction Capacitance (Note 2)	CJ	70						45		pF
Typical Thermal Resistance (Note 3)	RθJA	20								°C/W
Operating Junction Temperature Range	TJ	-65 ~ +150								°C
Storage Temperature Range	TSTG	-65 ~ +150								°C

Note 1. Reverse recovery test condition: IF=0.5A, IR=1.0A, Irr=0.25A  
 2. Measured at 1.0MHz and applied reverse voltage of 4.0 Volts  
 3. Thermal resistance from junction to ambient, both leads are attached to heatsink 20x20x1t(mm) copper plate at lead length 5mm

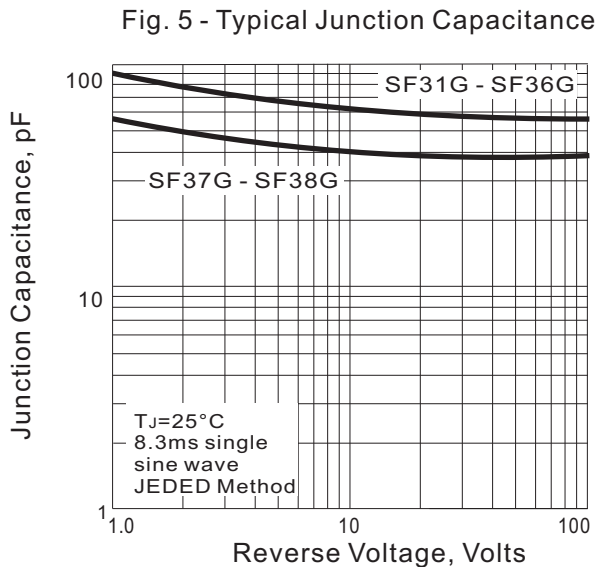
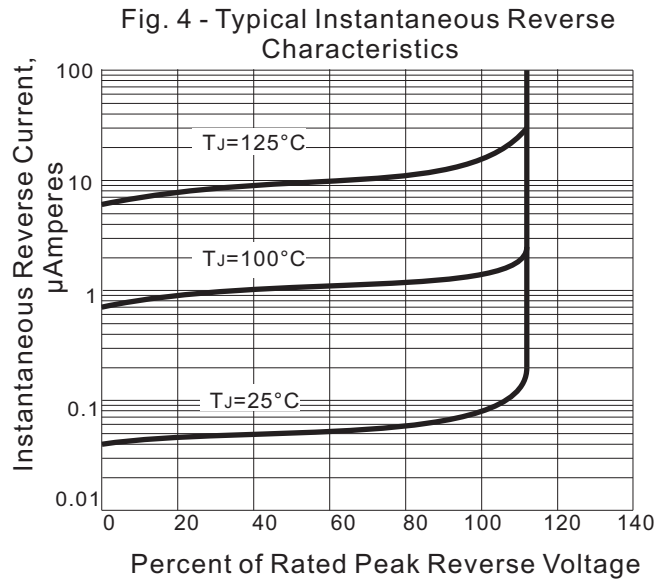
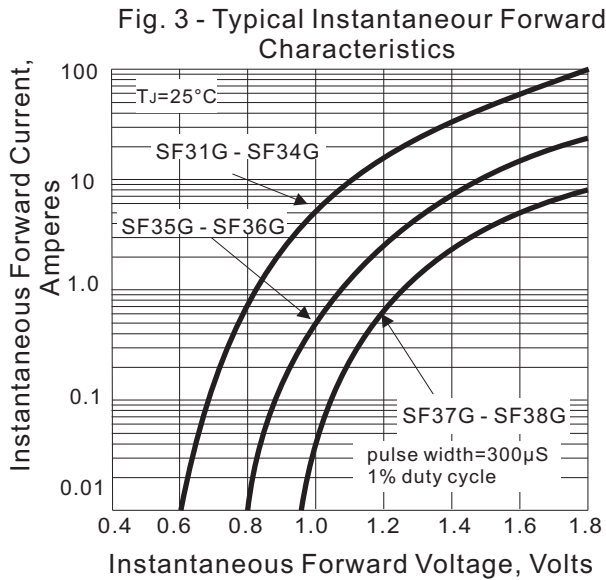
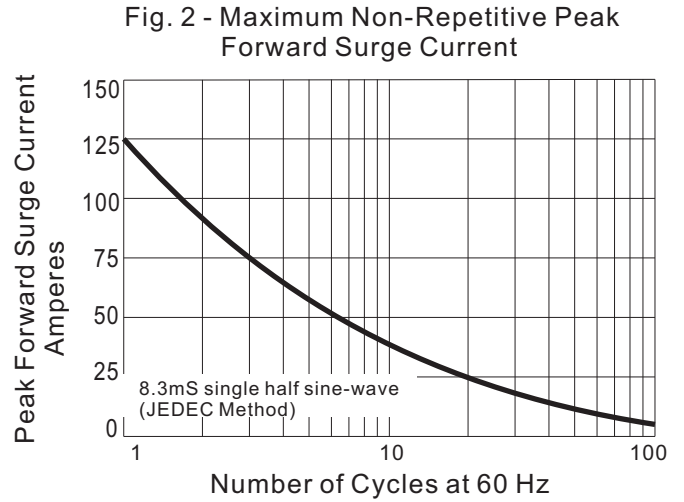
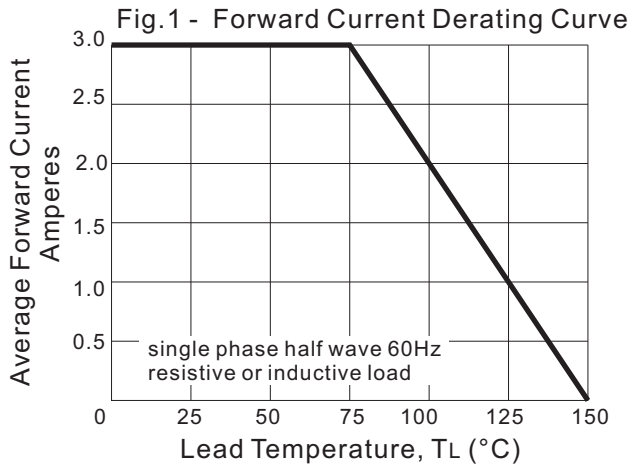
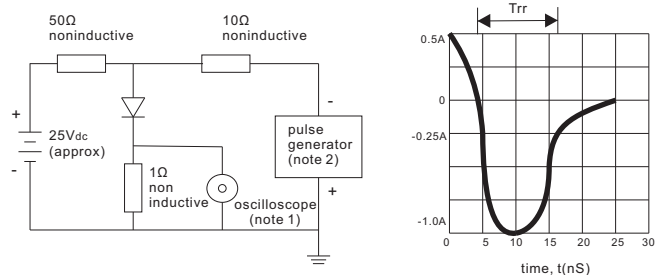

Fig. 6 - Test Circuit Diagram and Reverse Recovery Time Characteristic



Note: 1. rise time=7nS Max. input impedance=1MΩ, 22pF  
 2. rise time=10nS Max. source impedance=80Ω