

# SF51G thru SF58G

## Glass Passivated Junction Ultra Fast Rectifiers Reverse Voltage 50 to 600V Forward Current 5.0A

### FEATURES

- \* Plastic package has Underwriters Laboratory Flammability Classification 94V-0
- \* High temperature metallurgically bonded construction
- \* Glass passivated chip
- \* Capable of meeting environmental standards of MIL-S-19500
- \* For use in high frequency rectifier circuits
- \* Fast switching for high efficiency
- \* High temperature soldering guaranteed: 260°C/10 seconds
- \* 0.375" (9.5mm) lead length, 5 lbs. (2.3kg) tension

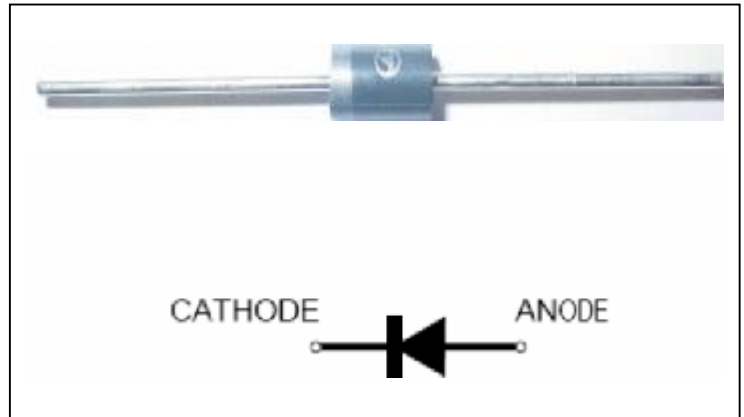

We declare that the material of product compliance with ROHS requirements

### Mechanical Data

- Case:** JEDEC DO-201AD, molded plastic  
**Terminals:** Plated axial leads, solderable per MIL-STD-750, Method 2026  
**Polarity:** Color band denotes cathode end  
**Mounting Position:** Any  
**Weight:** 0.038 oz., 1.03 g  
**Handling precaution:** None

### 1. Maximum & Thermal Characteristics Ratings at 25°C ambient temperature unless otherwise specified.

| Parameter Symbol   | symbol          | SF51G       | SF52G | SF53G | SF54G | SF55G | SF56G | SF57G | SF58G | Unit |
|--|-----------------|-------------|-------|-------|-------|-------|-------|-------|-------|------|
| Marking spec   |                 | SF51G       | SF52G | SF53G | SF54G | SF55G | SF56G | SF57G | SF58G |      |
| Maximum repetitive peak reverse voltage  | $V_{RRM}$       | 50          | 100   | 150   | 200   | 300   | 400   | 500   | 600   | V    |
| Maximum RSM voltage  | $V_{RSM}$       | 35          | 70    | 105   | 140   | 210   | 280   | 350   | 420   | V    |
| Maximum DC blocking voltage  | $V_{DC}$        | 50          | 100   | 150   | 200   | 300   | 400   | 500   | 600   | V    |
| Maximum average forward rectified current 0.375" (9.5mm) lead length at $T_A = 55^\circ\text{C}$ | $I_{F(AV)}$     | 5.0         |       |       |       |       |       |       |       | A    |
| Peak forward surge current 8.3ms single half sine-wave superimposed on rated load (JEDEC Method) | $I_{FSM}$       | 150         |       |       |       |       |       |       |       | A    |
| Maximum DC blocking voltage temperature  | $T_A$           | 150         |       |       |       |       |       |       |       | °C   |
| Typical thermal resistance (Note 2)  | $R_{\theta JA}$ | 20          |       |       |       |       |       |       |       | °C/W |
| Operating junction temperature range   | $T_J$           | -50 to +150 |       |       |       |       |       |       |       | °C   |
| Storage temperature range  | $T_{STG}$       | -50 to +150 |       |       |       |       |       |       |       | °C   |

### Electrical Characteristics Ratings at 25°C ambient temperature unless otherwise specified.

| Parameter Symbol  | symbol   | SF51G | SF52G | SF53G | SF54G | SF55G | SF56G | SF57G | SF58G | Unit |               |
|---|----------|-------|-------|-------|-------|-------|-------|-------|-------|------|---------------|
| Maximum instantaneous forward voltage at 5.0A   | $V_F$    | 0.95  |       |       | 1.25  |       |       | 1.7   |       | V    |               |
| Maximum DC reverse current $T_A = 25^\circ\text{C}$<br>at rated DC blocking voltage $T_A = 125^\circ\text{C}$ | $I_R$    | 10    |       |       |       |       |       |       |       |      | $\mu\text{A}$ |
| Typical reverse recovery time (Note 1)  | $t_{rr}$ | 35    |       |       |       |       |       |       |       |      | ns            |
| Typical junction capacitance at 4.0V, 1MHz  | $C_J$    | 50    |       |       |       | 30    |       |       |       |      | PF            |

NOTES:

1.  $I_F = 0.5\text{A}$ ,  $I_R = 1.0\text{A}$ ,  $IRR = 0.25\text{A}$
2. Thermal resistance from junction to ambient at 0.375" (9.5mm) lead length, P.C.B. mounted

# SF51G thru SF58G

## 2. Ratings and Characteristic Curves (TA = 25°C unless otherwise noted)

Fig. 1 - Forward Current Derating Curve

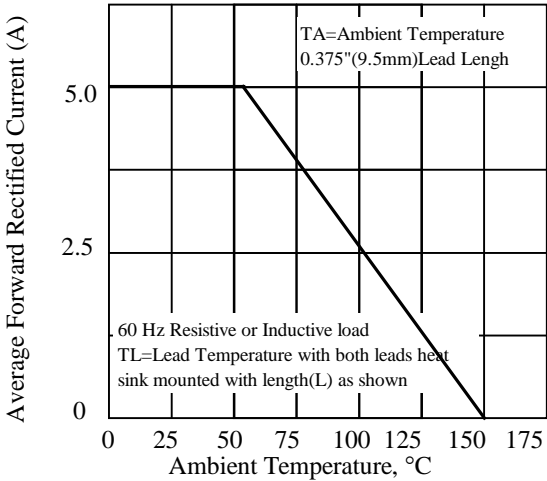

Fig. 2 - Maximum Non-repetitive Peak Forward Surge Current

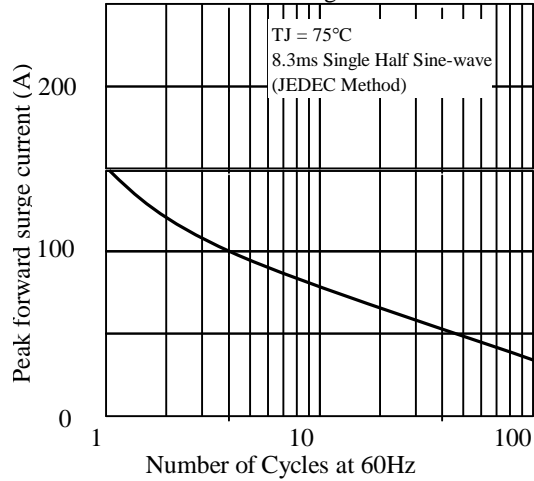

Fig. 3 - Typical Instantaneous Forward Characteristics

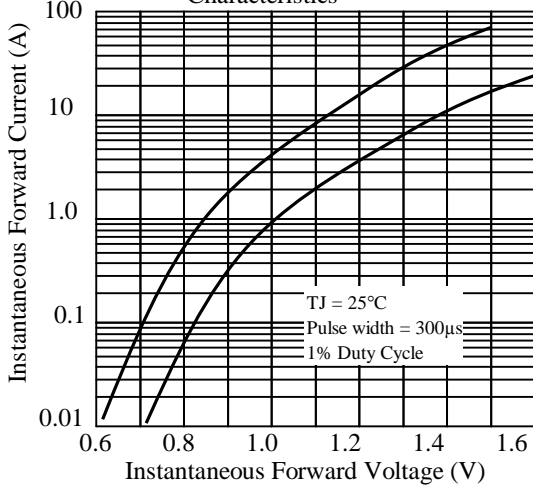

Fig. 4 - Typical Reverse Characteristics

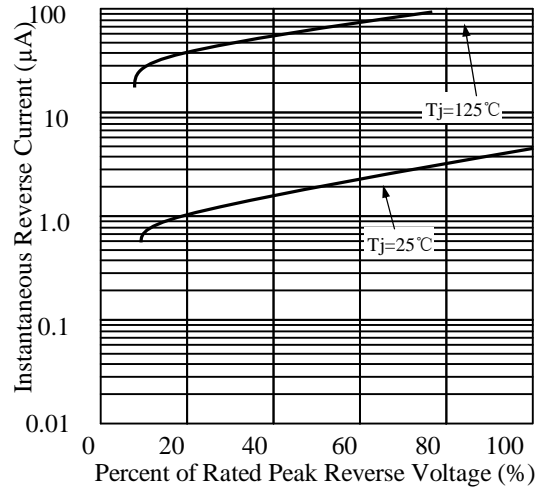

Fig. 5 - typical transient thermal impedance

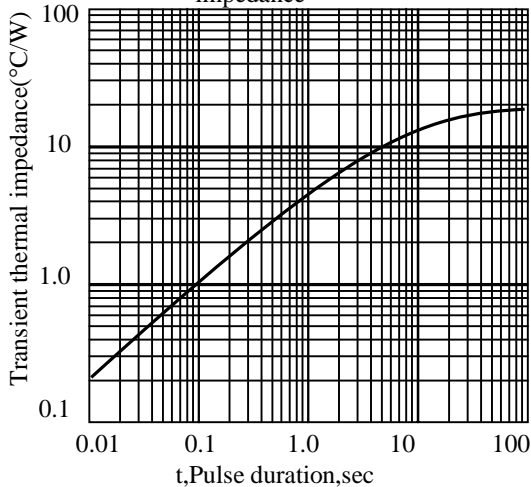
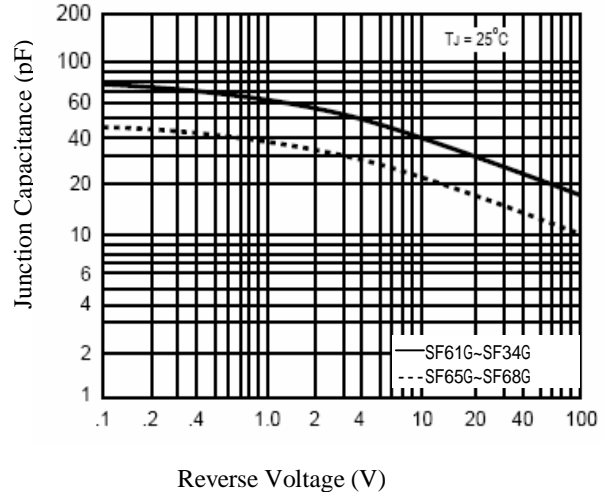
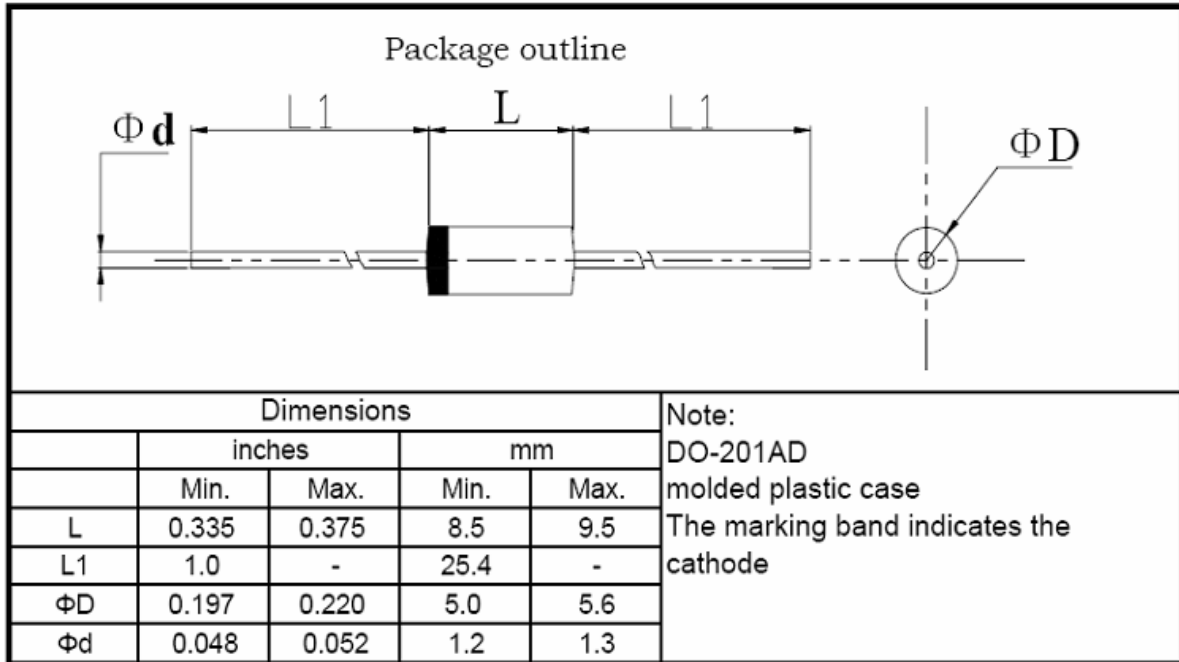

Fig. 6 - Typical Junction Capacitance



## SF51G thru SF58G

### 3. dimension:



标题:

塑封生产线轴向产品包装规范

文件编号: WI-250

第 4 版 第 0 次修改

第 1 页

1 弹带盒装 ammo and box

1.1. 弹带盒规格 ammo spec.

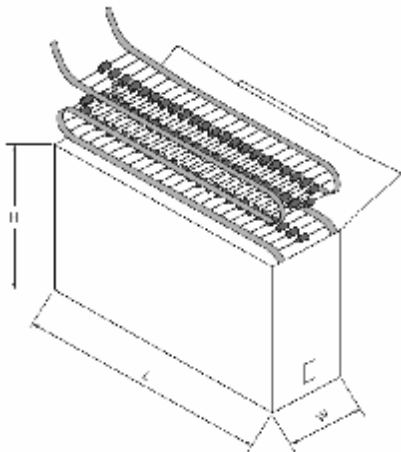

单位: mm

|     | L     | W    | H    |
|-----|-------|------|------|
| T52 | 262±2 | 76±2 | 90±2 |
| T42 | 262±2 | 64±2 | 90±2 |
| T26 | 250±3 | 45±3 | 95±3 |

1.2 弹带内盒要求 inner box spec.

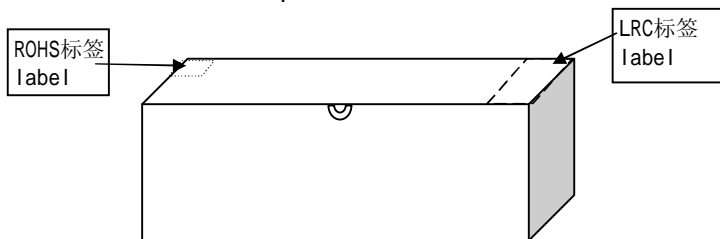

|                             |               |
|-----------------------------|---------------|
| 标题:<br><b>塑封生产线轴向产品包装规范</b> | 文件编号: WI-250  |
|                             | 第 4 版 第 0 次修改 |
|                             | 第 2 页         |

1.4 标签要求 label spec.

1.4.1 LRC标签 LRC label

成型 FORMING \*\*\*\*\* ← 成型规格 forming spec.

型号 TYPE \*\*\*\*\* ← LRC产品型号 type

|                                |       |                                   |
|--------------------------------|-------|-----------------------------------|
| 重复峰压 (V)<br>PRV (V)            | ****  | ← 产品重复峰压值 peak repetitive voltage |
| 额定电流 (A)<br>I <sub>o</sub> (A) | **    | ← 产品额定电流值 average output current  |
| 数量 (只)<br>QTY (pcs)            | ****  | ← 产品数量 quantity                   |
| 检验员<br>CHECKER                 | 02    |                                   |
| 日期:<br>DATE:                   | ***** | ← 产品生产日期 date                     |

1.4.2 环保标签 environmental protection label

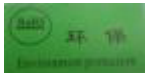

2. 外箱规格 carton spec.

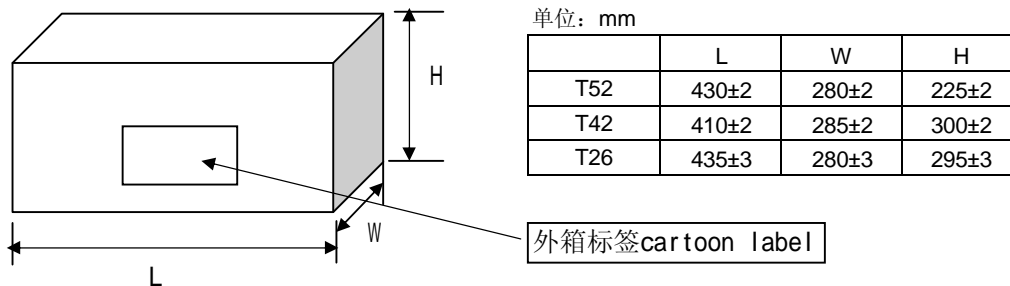

3 按以上包装方式, 编带数量和外包装箱产品数量: typing and carton spec.

|                                  | 塑封外型                |       |                      |          |
|----------------------------------|---------------------|-------|----------------------|----------|
|                                  | A-405 & DO-41 & R-1 | R-3   | DO-15                | DO-201AD |
| 每根编带数量<br>quantity/ammo          | 3K                  | 1.8K  | 2K(T52)<br>1.8K(T26) | 0.8K     |
| 外箱数量 (T52编带)<br>quantity/cartoon | 30K                 | 18K   | 20K                  | 8.0K     |
| 外箱数量 (T26编带)<br>quantity/cartoon | 60K                 | 36K   | 36K                  | -        |
| 外箱数量 (T42编带)<br>quantity/cartoon | 54K                 | 32.4K | 36K                  | -        |

|                             |               |
|-----------------------------|---------------|
| 标题：<br><b>塑封生产线轴向产品包装规范</b> | 文件编号：WI-250   |
|                             | 第 4 版 第 0 次修改 |
|                             | 第 3 页         |

4 编带规格 brede spec

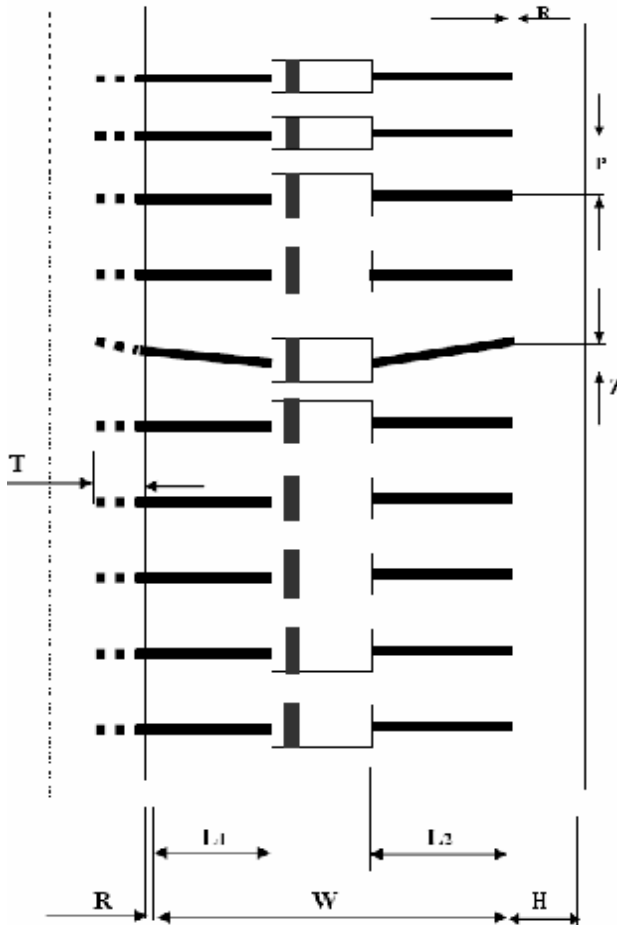

| 尺寸代号         | 编带尺寸 typing dimension |              |              |              |              |              |
|--------------|-----------------------|--------------|--------------|--------------|--------------|--------------|
|              | 26/tape               | 35/tape      | 40/tape      | 42/tape      | 52/tape      | 52/tape#     |
| <b>W</b>     | 26 0.0/+1.6           | 35 -1.0/+0.5 | 40 -1.0/+0.5 | 42 -1.0/+1.0 | 52 -1.0/+2.0 | 52 -1.0/+2.0 |
| <b>P</b>     | 5±0.5                 | 5±0.5        | 5±0.5        | 5±0.5        | 5±0.5        | 10±0.5       |
| <b>L1-L2</b> | <1.0                  | <1.0         | <1.0         | <1.0         | <1.0         | <1.0         |
| <b>H</b>     | 6±1.0                 | 6±1.0        | 6±1.0        | 6±1.0        | 6±1.0        | 6±1.0        |
| <b>Z</b>     | <1.0                  | <1.0         | <1.0         | <1.0         | <1.0         | <1.0         |
| <b>R</b>     | <1.0                  | <1.0         | <1.0         | <1.0         | <1.0         | <1.0         |
| <b>T</b>     | >3.5                  | >3.5         | >3.5         | >3.5         | >3.5         | >3.5         |

注：52编带# 为DO-201AD编带规格 "52编带#" just for D0-201AD

1. 红白编带厚度为0.05mm；两种胶带各自之间无明显色差；编带要求均为胶带。  
The typing thickness is 0.05mm and color is obvious difference
2. 两端引带20~40cm. Typing lead over 20~40cm
3. 红色编带一端为二极管“负极”；白色编带一端为二极管“正极”。  
red color is cathode ,white color is anode
4. 无卤 green epoxy compound (无卤产品才贴HF only)

**Green**

## SF51G thru SF58G

### 4. Update Record

| 版次 | 更新记录    | 更新作者 | 更新日期      |
|----|---------|------|-----------|
| 1  | 第一版     | 周杰   | 2010-6-22 |
| 2  | 增加包装规范  | 周杰   | 2011-6-30 |
| 3  | 增加SF57G | 周杰   | 2012-2-13 |