

ULTRAFast RECOVERY POWER RECTIFIER

Features

- High voltage and high reliability
- Ultrafast reverse recovery time
- High speed switching
- Low power loss and High efficiency
- Halogen-free component and RoHS compliant device

Applications

- General purpose
- Switching mode power supply
- Free-wheeling diode for motor application
- Power switching circuits
- DC-DC converter systems

Description

The SF5A400HD is ideally as boost diode in discontinuous or critical mode power factor corrections. The device is also intended for use as a freewheeling diode in power supplies and other power switching applications.

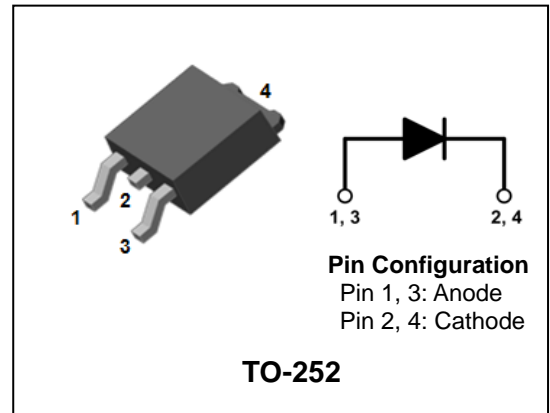

Product Characteristics

$I_{F(AV)}$	5A
V_{RRM}	400V
$V_{FM} @ T_j=125^\circ\text{C}$	1.2V
t_{rr}	30ns

Ordering Information

Device	Marking Code	Package	Packaging
SF5A400HD	SF5A400HD	TO-252	Tape & Reel

Marking Information

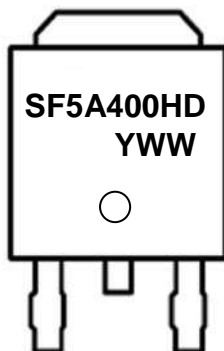

SF5A400HD = Specific Device Code
 YWW = Year & Week Code Marking
 -. Y = Year Code
 -. WW = Week Code

Absolute Maximum Ratings (Limiting Values)

Characteristic	Symbol	Value	Unit
Maximum repetitive reverse voltage Maximum working peak reverse voltage Maximum DC blocking voltage	V_{RRM} V_{RWM} V_R	400	V
Maximum average forward rectified current	$I_{F(AV)}$	5	A
Peak forward surge current 8.3ms single half sine-wave superimposed on rated load per diode	I_{FSM}	60	A
Storage temperature range	T_{stg}	-45 to +150	°C
Maximum operating junction temperature	T_J	150	

Thermal Characteristics

Characteristic	Symbol	Value	Unit
Maximum thermal resistance junction to case	$R_{th(j-c)}$	6.0	°C/W

Electrical Characteristics

Characteristic	Symbol	Test Condition	Min.	Typ.	Max.	Unit	
Peak forward voltage drop	$V_{FM}^{(1)}$	$I_{FM} = 5A$	$T_J = 25^\circ C$	-	-	1.40	V
			$T_J = 125^\circ C$	-	-	1.20	
Reverse leakage current	I_{RM}	$V_R = V_{RRM}$	$T_J = 25^\circ C$	-	-	20	uA
			$T_J = 125^\circ C$	-	-	200	
Reverse recovery time	t_{rr}	$I_F = 1A, di/dt = -100 A/us$	-	-	30	ns	
Junction capacitance	C_j	$V_R = 4V_{DC}, f=1MHz$	-	-	100	pF	

Note : (1) Pulse test : $t_p \leq 380us$, Duty cycle $\leq 2\%$

Rating & Electrical Characteristic Curves

Fig. 1) Typical Forward Characteristics

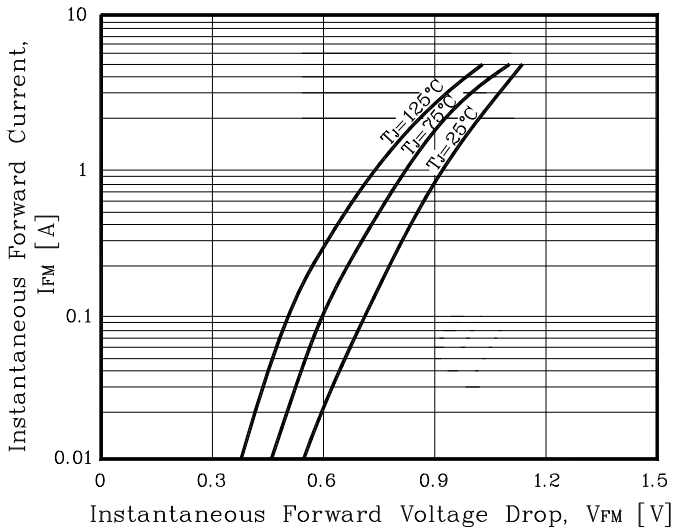

Fig. 2) Typical Reverse Characteristics

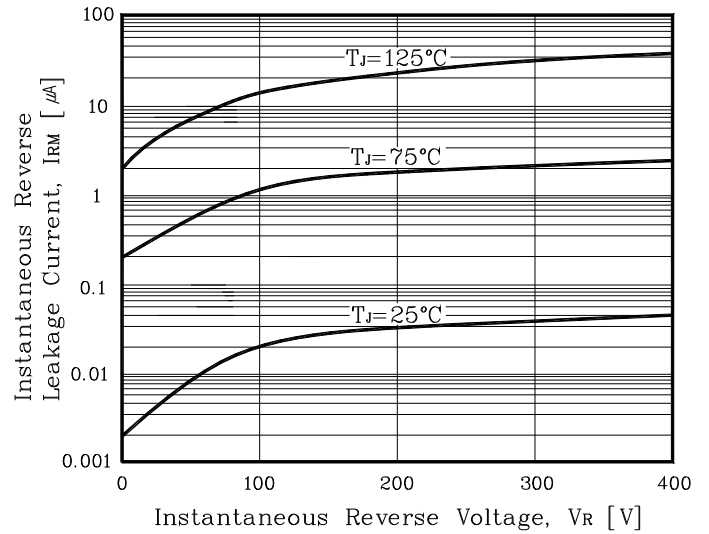

Fig. 3) Maximum Forward Derivative Curve

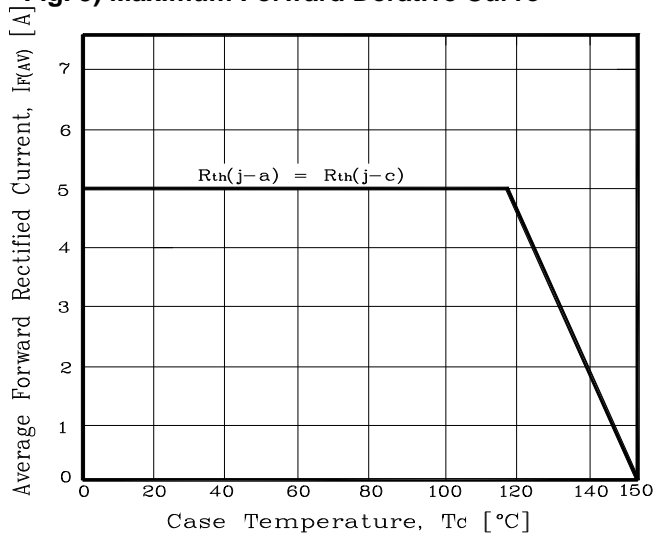

Fig. 4) Forward Power Dissipation

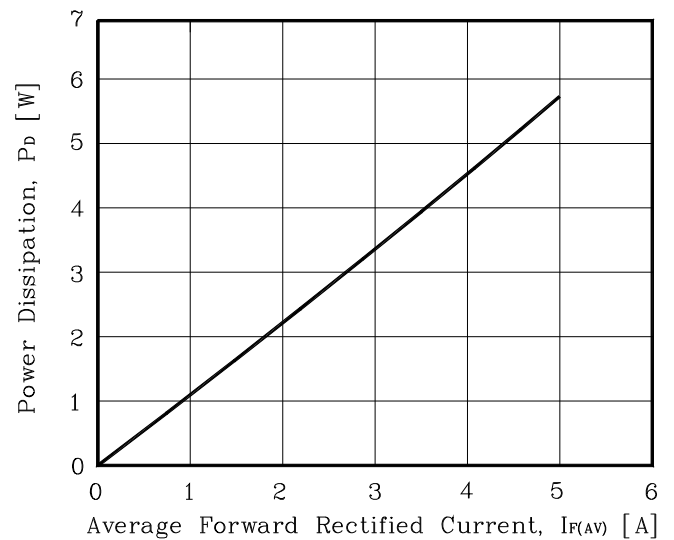

Fig. 5) Maximum Non-Repetitive Peak Forward Surge Current

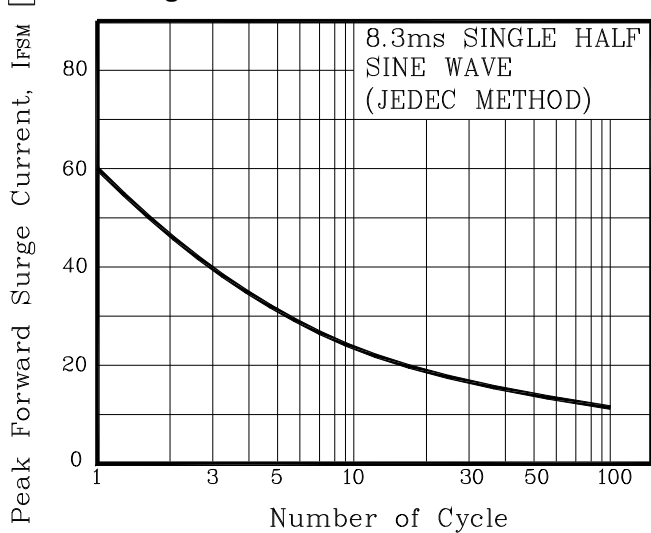
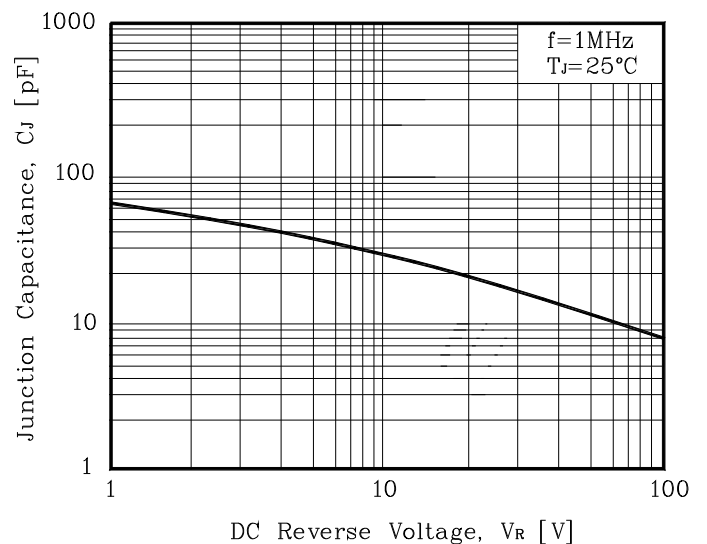
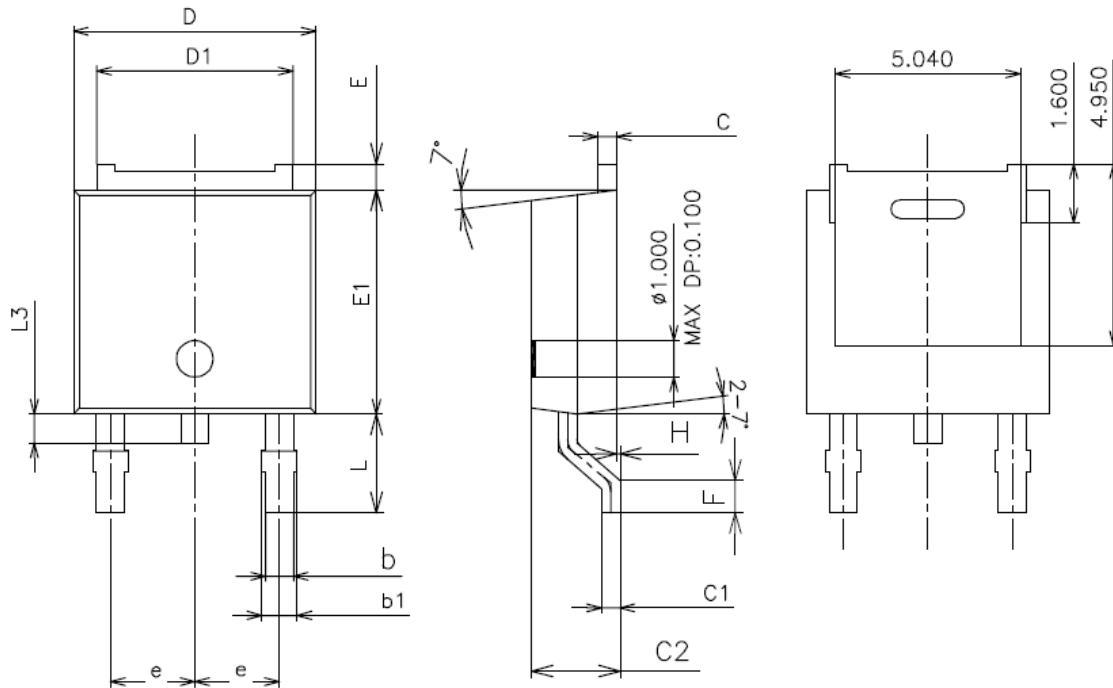

Fig. 6) Typical Junction Capacitance



Package Outline Dimension (Unit: mm)



SYMBOL	MILLIMETERS			NOTE
	MINIMUM	NOMINAL	MAXIMUM	
D	6.40	6.60	6.80	
D1	5.14	5.34	5.54	
E	0.50	0.70	0.90	
E1	5.90	6.10	6.30	
A	2.20	2.30	2.40	
A1	0.87	1.07	1.27	
C	0.40	0.50	0.60	
C1	0.40	0.50	0.60	
C2	2.10	2.30	2.50	
L	2.50	2.70	2.90	
L3	0.60	0.80	1.00	
b	0.66	0.76	0.86	
b1	0.96 MAX			
e	2.10	2.30	2.50	
F	0.80 Min			
H	0	-	0.100	

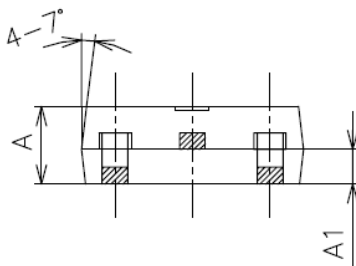

※ Recommended Land Pattern (unit: mm)

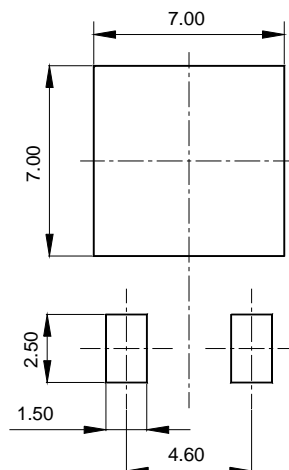

The AUK Corp. products are intended for the use as components in general electronic equipment (Office and communication equipment, measuring equipment, home appliance, etc.).

Please make sure that you consult with us before you use these AUK Corp. products in equipments which require high quality and / or reliability, and in equipments which could have major impact to the welfare of human life(atomic energy control, airplane, spaceship, transportation, combustion control, all types of safety device, etc.). AUK Corp. cannot accept liability to any damage which may occur in case these AUK Corp. products were used in the mentioned equipments without prior consultation with AUK Corp..

Specifications mentioned in this publication are subject to change without notice.