

GaAlAs-Lumineszenzdiode
GaAlAs Infrared Emitter
Lead (Pb) Free Product - RoHS Compliant

SFH 483 L/M E7800



Wesentliche Merkmale

- Hergestellt im Schmelzepitaxieverfahren
- Anode galvanisch mit dem Gehäuseboden verbunden
- Hohe Zuverlässigkeit
- Gute spektrale Anpassung an Si-Fotoempfänger
- Gehäusegleich mit BPX 63, BP 103, LD 242, SFH 464
- Anwendungsklasse nach DIN 40 040 GQC

Features

- Fabricated in a liquid phase epitaxy process
- Anode is electrically connected to the case
- High reliability
- Matches all Si-Photodetectors
- Same package as BPX 63, BP 103, LD 242, SFH 464
- DIN humidity category in acc. with DIN 40 040 GQG

Anwendungen

- Lichtschranken für Gleich- und Wechsellichtbetrieb
- Sensorik
- Lichtgitter

Applications

- Photointerrupters
- Sensor technology
- Light-grille barrier

Typ Type	Bestellnummer Ordering Code	Strahlstärkegruppierung ¹⁾ ($I_F = 100\text{mA}$, $t_p = 20\text{ ms}$) Radiant Intensity Grouping ¹⁾ I_e (mW/sr)
SFH 483 L/M E7800	Q62703Q4755	2 (> 1)

¹⁾ gemessen bei einem Raumwinkel $\Omega = 0.01\text{ sr}$
 measured at a solid angle of $\Omega = 0.01\text{ sr}$

Grenzwerte ($T_A = 25\text{ °C}$)**Maximum Ratings**

Bezeichnung Parameter	Symbol Symbol	Wert Value	Einheit Unit
Betriebs- und Lagertemperatur Operating and storage temperature range	$T_{op}; T_{stg}$	- 40 ... + 80	°C
Sperrspannung Reverse voltage	V_R	5	V
Vorwärtsgleichstrom Forward current	I_F	200	mA
Stoßstrom, $t_p = 10\ \mu\text{s}$, $D = 0$ Surge current	I_{FSM}	2.5	A
Verlustleistung Power dissipation	P_{tot}	470	mW
Wärmewiderstand Thermal resistance	R_{thJA} R_{thJC}	450 160	K/W K/W

Kennwerte ($T_A = 25\text{ °C}$)**Characteristics**

Bezeichnung Parameter	Symbol Symbol	Wert Value	Einheit Unit
Wellenlänge der Strahlung Wavelength at peak emission $I_F = 100\text{ mA}$	λ_{peak}	880	nm
Spektrale Bandbreite bei 50% von I_{max} Spectral bandwidth at 50% of I_{max} $I_F = 100\text{ mA}$	$\Delta\lambda$	80	nm
Abstrahlwinkel Half angle	φ	± 23	Grad deg.
Aktive Chipfläche Active chip area	A	0.16	mm ²
Abmessungen der aktiven Chipfläche Dimension of the active chip area	$L \times B$ $L \times W$	0.4×0.4	mm ²
Abstand Gehäuserückseite bis Chipoberfläche Distance chip front to case back	H	2.7 ... 2.9	mm
Schaltzeiten, I_e von 10% auf 90% und von 90% auf 10%, bei $I_F = 100\text{ mA}$, $R_L = 50\ \Omega$ Switching times, I_e from 10% to 90% and from 90% to 10%, $I_F = 100\text{ mA}$, $R_L = 50\ \Omega$	t_r, t_f	0.6/0.5	μs

Kennwerte ($T_A = 25\text{ °C}$)
Characteristics (cont'd)

Bezeichnung Parameter	Symbol Symbol	Wert Value	Einheit Unit
Kapazität Capacitance $V_R = 0\text{ V}, f = 1\text{ MHz}$	C_o	25	pF
Durchlassspannung Forward voltage $I_F = 100\text{ mA}, t_p = 20\text{ ms}$ $I_F = 1\text{ A}, t_p = 100\text{ }\mu\text{s}$	V_F	1.5 (< 1.8) 2.4 (< 3.0)	V
Sperrstrom Reverse current $V_R = 5\text{ V}$	I_R	0.01 (≤ 1)	μA
Gesamtstrahlungsfluss Total radiant flux $I_F = 100\text{ mA}, t_p = 20\text{ ms}$	Φ_e	23	mW
Temperaturkoeffizient von I_e bzw. Φ_e , $I_F = 100\text{ mA}$ Temperature coefficient of I_e or Φ_e , $I_F = 100\text{ mA}$	TC_I	- 0.5	%/K
Temperaturkoeffizient von V_F , $I_F = 100\text{ mA}$ Temperature coefficient of V_F , $I_F = 100\text{ mA}$	TC_V	- 2.5	mV/K
Temperaturkoeffizient von λ , $I_F = 100\text{ mA}$ Temperature coefficient of λ , $I_F = 100\text{ mA}$	TC_λ	+ 0.25	nm/K

Strahlstärke I_e in Achsrichtung (gemessen bei einem Raumwinkel $\Omega = 0.01$ sr)

Radiant Intensity I_e in Axial Direction (at a solid angle of $\Omega = 0.01$ sr)

Bezeichnung Parameter	Symbol	Werte Values		Einheit Unit
		SFH 483-L E7800	SFH483-M E7800	
Strahlstärke ¹⁾				
Radiant intensity	$I_{e \text{ min}}$	1	1.6	mW/sr
$I_F = 100$ mA, $t_p = 20$ ms	$I_{e \text{ max}}$	2	3.2	mW/sr

¹⁾ Die Messung der Strahlstärke und des Halbwinkels erfolgt mit einer Lochblende vor dem Bauteil (Durchmesser der Lochblende: 1,1 mm; Abstand Lochblende zu Gehäuserückseite: 4,0 mm). Dadurch wird sichergestellt, dass bei der Strahlstärkemessung nur diejenige Strahlung in Achsrichtung bewertet wird, die direkt von der Chipoberfläche austritt. Von der Bodenplatte reflektierte Strahlung (vagabundierende Strahlung) wird dagegen nicht bewertet. Diese Reflexionen sind besonders bei Abbildungen der Chipoberfläche über Zusatzoptiken störend (z.B. Lichtschranken großer Reichweite). In der Anwendung werden im allgemeinen diese Reflexionen ebenfalls durch Blenden unterdrückt. Durch dieses, der Anwendung entsprechende, Messverfahren ergibt sich für den Anwender eine besser verwertbare Größe. Diese Lochblendenmessung ist gekennzeichnet durch den Eintrag „E 7800“, der an die Typenbezeichnung angehängt ist.

¹⁾ An aperture is used in front of the component for measurement of the radiant intensity and the half angle (diameter of the aperture: 1.1 mm; distance of aperture to case back side: 4.0 mm). This ensures that solely the radiation in axial direction emitting directly from the chip surface will be evaluated during measurement of the radiant intensity. Radiation reflected by the bottom plate (stray radiation) will not be evaluated. These reflections impair the projection of the chip surface by additional optics (e.g. long-range light reflection switches). In respect of the application of the component, these reflections are generally suppressed by apertures as well. This measuring procedure corresponding with the application provides more useful values. This aperture measurement is denoted by “E 7800” added to the type designation.

Relative Spectral Emission

$I_{rel} = f(\lambda)$

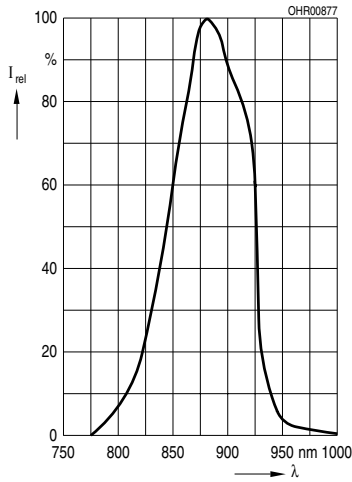

Radiant Intensity $\frac{I_e}{I_e 100 \text{ mA}} = f(I_F)$

Single pulse, $t_p = 20 \mu\text{s}$

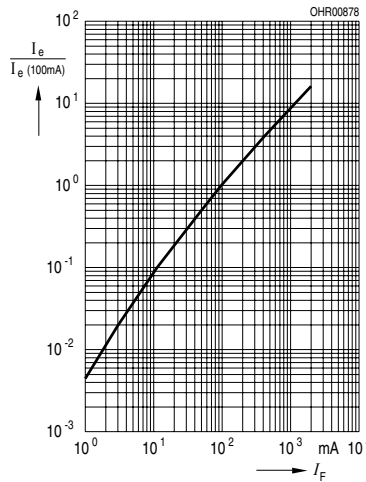

Max. Permissible Forward Current

$I_F = f(T_A)$

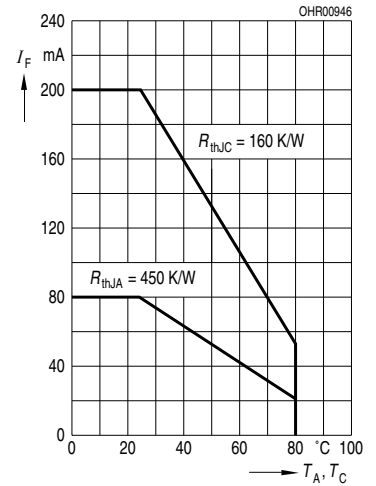

Forward Current $I_F = f(V_F)$

Single pulse, $t_p = 20 \mu\text{s}$

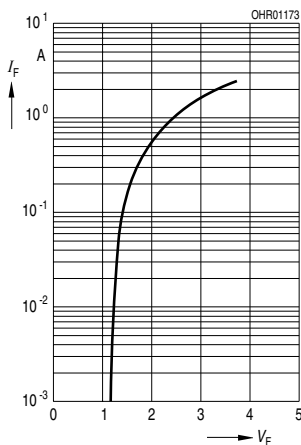

Permissible Pulse Handling Capability

$I_F = f(t_p, T_C = 25 \text{ °C}, \text{duty cycle } D = \text{parameter})$

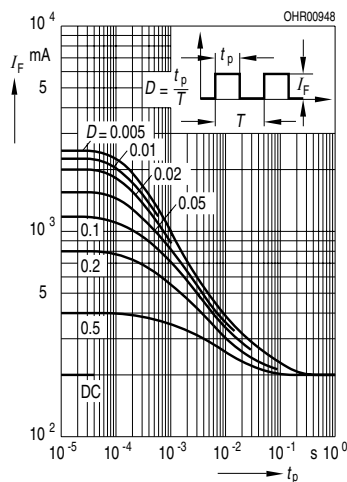

Radiation Characteristics¹⁾ $I_{rel} = f(\varphi)$

$I_{rel} = f(\varphi)$

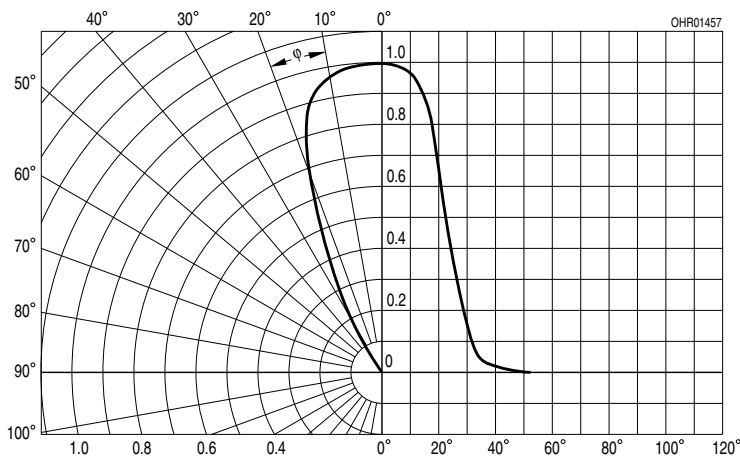

Maßzeichnung
Package Outlines

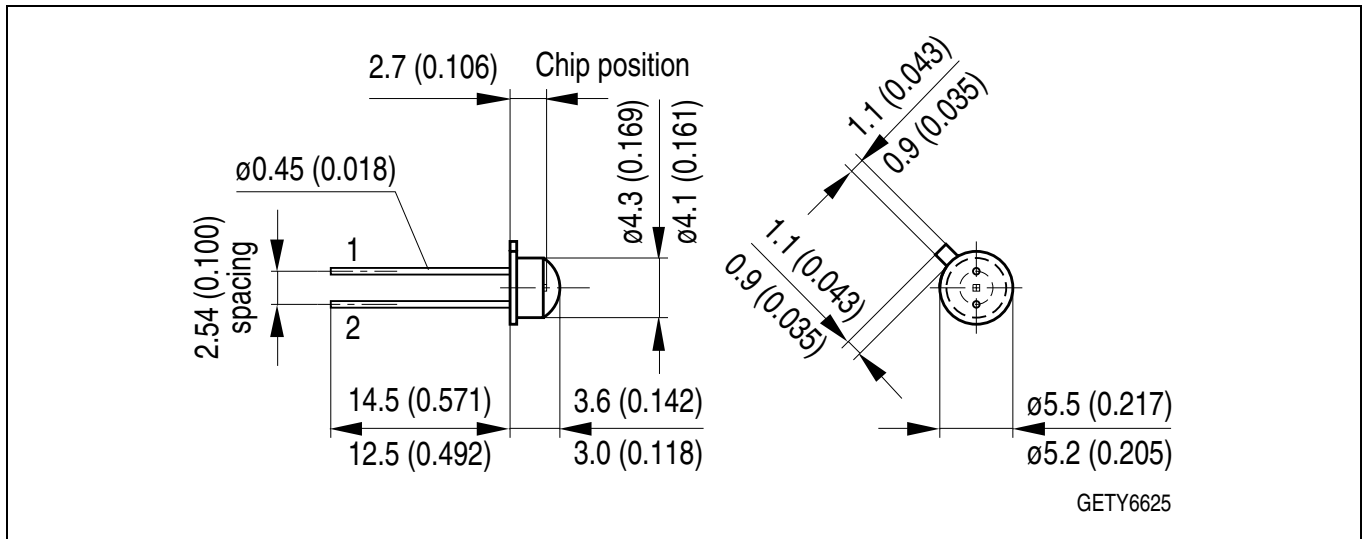

Maße werden wie folgt angegeben: mm (inch) / Dimensions are specified as follows: mm (inch).

Gehäuse Package	18 A3 DIN 41870 (TO-18), klares Epoxy-Gießharz 18 A3 DIN 41876 (TO-18), transparent epoxy resin
Anschlussbelegung pin configuration	1 = Kathode/ cathode 2 = Anode/ anode

Lötbedingungen
Soldering Conditions
Wellenlöten (TTW)
TTW Soldering

(nach CECC 00802)

(acc. to CECC 00802)

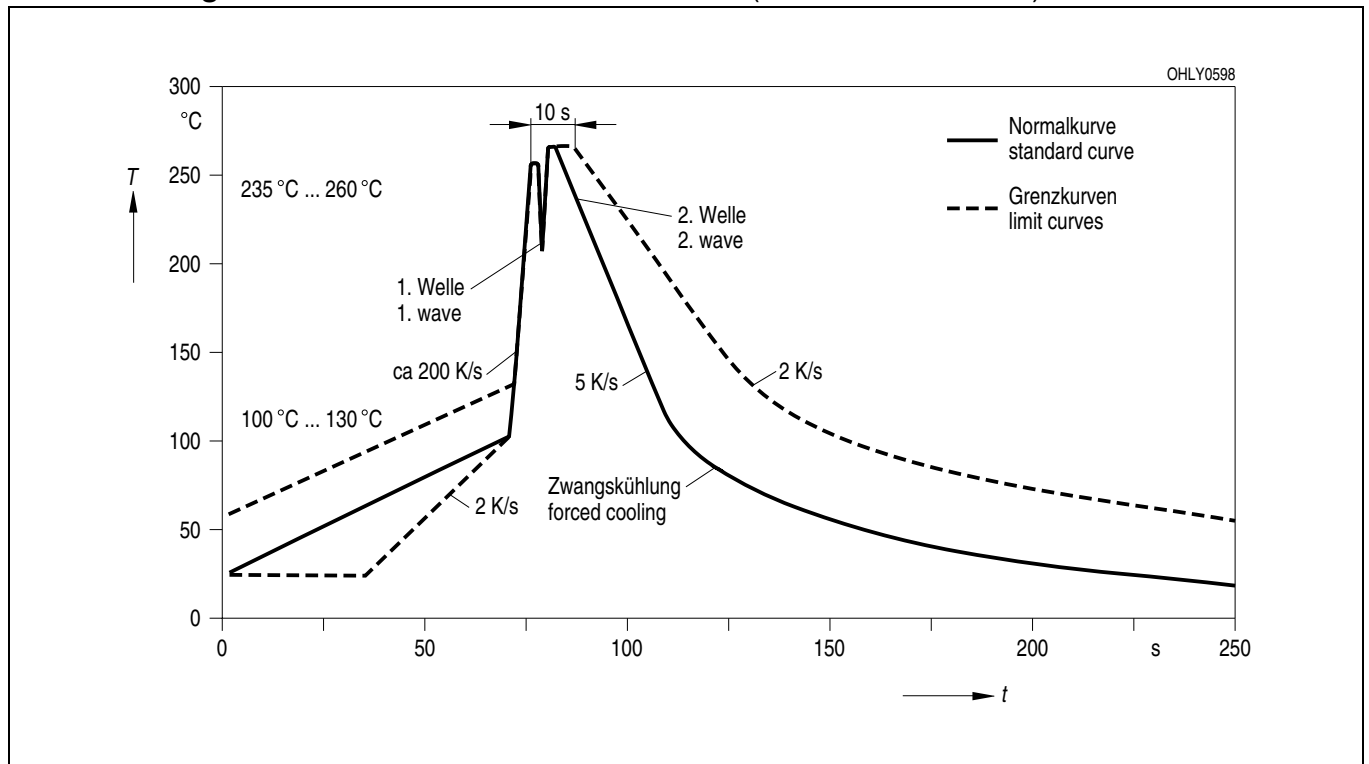

Published by
OSRAM Opto Semiconductors GmbH
 Wernerwerkstrasse 2, D-93049 Regensburg
www.osram-os.com

© All Rights Reserved.

The information describes the type of component and shall not be considered as assured characteristics. Terms of delivery and rights to change design reserved. Due to technical requirements components may contain dangerous substances. For information on the types in question please contact our Sales Organization.

Packing

Please use the recycling operators known to you. We can also help you – get in touch with your nearest sales office. By agreement we will take packing material back, if it is sorted. You must bear the costs of transport. For packing material that is returned to us unsorted or which we are not obliged to accept, we shall have to invoice you for any costs incurred.

Components used in life-support devices or systems must be expressly authorized for such purpose! Critical components ¹, may only be used in life-support devices or systems ² with the express written approval of OSRAM OS.

¹ A critical component is a component used in a life-support device or system whose failure can reasonably be expected to cause the failure of that life-support device or system, or to affect its safety or effectiveness of that device or system.

² Life support devices or systems are intended (a) to be implanted in the human body, or (b) to support and/or maintain and sustain human life. If they fail, it is reasonable to assume that the health of the user may be endangered.