

Optocoupler, Phototransistor Output, High Reliability, 5300 V_{RMS}

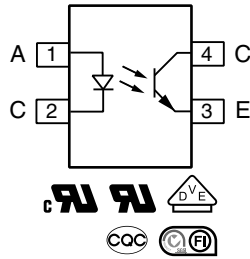
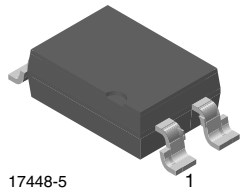

FEATURES

- Excellent CTR linearity depending on forward current
- Isolation test voltage, 5300 V_{RMS}
- Fast switching times
- Low CTR degradation
- Low coupling capacitance
- Material categorization: for definitions of compliance please see www.vishay.com/doc?99912

RoHS
COMPLIANT

LINKS TO ADDITIONAL RESOURCES

SPICE

Models

DESCRIPTION

The SFH6156 features a variety of transfer ratios, low coupling capacitance and high isolation voltage. This coupler has a GaAs infrared diode emitter, which is optically coupled to a silicon planar phototransistor detector, and is incorporated in a plastic SMD package.

The coupling devices are designed for signal transmission between two electrically separated circuits.

APPLICATIONS

- Switchmode power supply
- Telecom
- Battery powered equipment

AGENCY APPROVALS

The safety application model number covering all products in this datasheet is SFH615A. This model number should be used when consulting safety agency documents.

- [UL 1577](#)
- [cUL](#)
- [DIN EN 60747-5-5 \(VDE 0884-5\) available with option 1](#)
- [BSI](#)
- [CQC](#)
- [FIMKO](#)

ORDERING INFORMATION																															
<table border="1" style="margin: auto;"> <tr> <td>S</td><td>F</td><td>H</td><td>6</td><td>1</td><td>5</td><td>6</td><td>-</td><td>#</td><td>X</td><td>0</td><td>0</td><td>1</td><td>T</td> </tr> <tr> <td colspan="8" style="text-align: center;">PART NUMBER</td> <td style="text-align: center;">CTR BIN</td> <td colspan="3" style="text-align: center;">PACKAGE OPTION</td> <td style="text-align: center;">TAPE AND REEL</td> </tr> </table>	S	F	H	6	1	5	6	-	#	X	0	0	1	T	PART NUMBER								CTR BIN	PACKAGE OPTION			TAPE AND REEL				
S	F	H	6	1	5	6	-	#	X	0	0	1	T																		
PART NUMBER								CTR BIN	PACKAGE OPTION			TAPE AND REEL																			
AGENCY CERTIFIED/PACKAGE	CTR (%)																														
	10 mA																														
UL, cUL, BSI, FIMKO, CQC	40 to 80	63 to 125	100 to 200	160 to 320																											
SMD-4, 100 mil, pitch	SFH6156-1	SFH6156-2	SFH6156-3	SFH6156-4																											
	SFH6156-1T	SFH6156-2T	SFH6156-3T	SFH6156-4T																											
VDE, UL, cUL, BSI, FIMKO, CQC	40 to 80	63 to 125	100 to 200	160 to 320																											
SMD-4, 100 mil, pitch	SFH6156-1X001	SFH6156-2X001	SFH6156-3X001	-																											
	SFH6156-1X001T	SFH6156-2X001T	SFH6156-3X001T	SFH6156-4X001T																											
	-	-	SFH6156-3X001T1 ⁽¹⁾	-																											

Notes

- Additional options may be possible, please contact sales office
- ⁽¹⁾ T1 rotation in tape and reel packaging

ABSOLUTE MAXIMUM RATINGS ($T_{amb} = 25\text{ }^{\circ}\text{C}$, unless otherwise specified)				
PARAMETER	TEST CONDITION	SYMBOL	VALUE	UNIT
INPUT				
Reverse voltage		V_R	6	V
DC forward current		I_F	60	mA
Surge forward current	$t_p \leq 10\text{ }\mu\text{s}$	I_{FSM}	2.5	A
OUTPUT				
Collector emitter voltage		V_{CEO}	70	V
Emitter collector voltage		V_{ECO}	7	V
Collector current		I_C	50	mA
	$t_p \leq 1\text{ ms}$	I_C	100	mA
COUPLER				
Storage temperature range		T_{stg}	-55 to +150	$^{\circ}\text{C}$
Ambient temperature range		T_{amb}	-55 to +100	$^{\circ}\text{C}$
Soldering temperature ⁽¹⁾	max. 10 s	T_{slid}	260	$^{\circ}\text{C}$

Notes

- Stresses in excess of the absolute maximum ratings can cause permanent damage to the device. Functional operation of the device is not implied at these or any other conditions in excess of those given in the operational sections of this document. Exposure to absolute maximum ratings for extended periods of the time can adversely affect reliability
- Refer to reflow profile for soldering conditions for surface mounted devices (SMD)

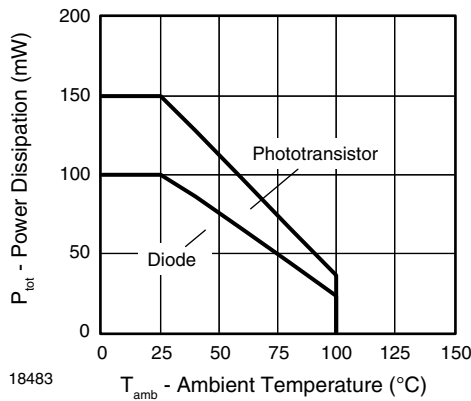
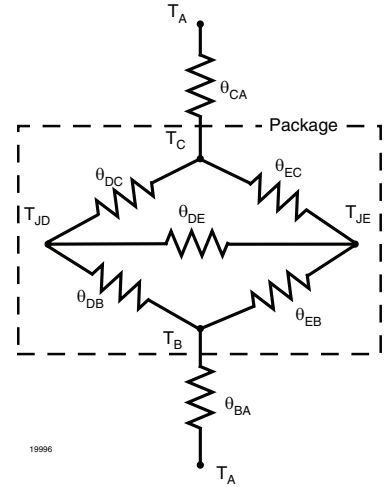

Fig. 1 - Permissible Power Dissipation vs. Ambient Temperature

THERMAL CHARACTERISTICS			
PARAMETER	SYMBOL	VALUE	UNIT
LED power dissipation	P_{diss}	100	mW
Output power dissipation	P_{diss}	150	mW
Maximum LED junction temperature	$T_{jmax.}$	125	°C
Maximum output die junction temperature	$T_{jmax.}$	125	°C
Thermal resistance, junction emitter to board	θ_{EB}	173	°C/W
Thermal resistance, junction emitter to case	θ_{EC}	149	°C/W
Thermal resistance, junction detector to board	θ_{DB}	111	°C/W
Thermal resistance, junction detector to case	θ_{DC}	127	°C/W
Thermal resistance, junction emitter to junction detector	θ_{ED}	95	°C/W
Thermal resistance, board to ambient ⁽¹⁾	θ_{BA}	195	°C/W
Thermal resistance, case to ambient ⁽¹⁾	θ_{CA}	3573	°C/W

Notes

- The thermal model is represented in the thermal network below. Each resistance value given in this model can be used to calculate the temperatures at each node for a given operating condition. The thermal resistance from board to ambient will be dependent on the type of PCB, layout and thickness of copper traces. For a detailed explanation of the thermal model, please reference Vishay's thermal characteristics of optocouplers application note

⁽¹⁾ For 2 layer FR4 board (4" x 3" x 0.062")

ELECTRICAL CHARACTERISTICS ($T_{amb} = 25\text{ °C}$, unless otherwise specified)							
PARAMETER	TEST CONDITION	PART	SYMBOL	MIN.	TYP.	MAX.	UNIT
INPUT							
Forward voltage	$I_F = 60\text{ mA}$		V_F	-	1.25	1.65	V
Reverse current	$V_R = 6\text{ V}$		I_R	-	0.01	10	μA
Capacitance	$V_R = 0\text{ V}$, $f = 1\text{ MHz}$		C_O	-	13	-	pF
OUTPUT							
Collector emitter capacitance	$V_{CE} = 5\text{ V}$, $f = 1\text{ MHz}$		C_{CE}	-	5.2	-	pF
Collector emitter leakage current	$V_{CE} = 10\text{ V}$	SFH6156-1	I_{CEO}	-	2	50	nA
		SFH6156-2	I_{CEO}	-	2	50	nA
		SFH6156-3	I_{CEO}	-	5	100	nA
		SFH6156-4	I_{CEO}	-	5	100	nA
COUPLER							
Collector emitter saturation voltage	$I_F = 10\text{ mA}$, $I_C = 2.5\text{ mA}$		V_{CEsat}	-	0.25	0.4	V
Coupling capacitance			C_C	-	0.4	-	pF

Note

- Minimum and maximum values are testing requirements. Typical values are characteristics of the device and are the result of engineering evaluation. Typical values are for information only and are not part of the testing requirements



CURRENT TRANSFER RATIO							
PARAMETER	TEST CONDITION	PART	SYMBOL	MIN.	TYP.	MAX.	UNIT
I_C/I_F	$I_F = 10\text{ mA}, V_{CE} = 5\text{ V}$	SFH6156-1	CTR	40	-	80	%
		SFH6156-2	CTR	63	-	125	%
		SFH6156-3	CTR	100	-	200	%
		SFH6156-4	CTR	160	-	320	%
	$I_F = 1\text{ mA}, V_{CE} = 5\text{ V}$	SFH6156-1	CTR	13	30	-	%
		SFH6156-2	CTR	22	45	-	%
		SFH6156-3	CTR	34	70	-	%
		SFH6156-4	CTR	56	90	-	%

SWITCHING CHARACTERISTICS ($T_{amb} = 25\text{ }^\circ\text{C}$, unless otherwise specified)							
PARAMETER	TEST CONDITION	PART	SYMBOL	MIN.	TYP.	MAX.	UNIT
NON-SATURATED							
Turn-on time	$I_F = 10\text{ mA}, V_{CC} = 5\text{ V}, R_L = 75\text{ }\Omega$		t_{on}	-	3	-	μs
Rise time	$I_F = 10\text{ mA}, V_{CC} = 5\text{ V}, R_L = 75\text{ }\Omega$		t_r	-	2	-	μs
Turn-off time	$I_F = 10\text{ mA}, V_{CC} = 5\text{ V}, R_L = 75\text{ }\Omega$		t_{off}	-	2.3	-	μs
Fall time	$I_F = 10\text{ mA}, V_{CC} = 5\text{ V}, R_L = 75\text{ }\Omega$		t_f	-	2	-	μs
Cut-off frequency	$I_F = 10\text{ mA}, V_{CC} = 5\text{ V}, R_L = 75\text{ }\Omega$		f_{CO}	-	250	-	kHz
SATURATED							
Turn-on time	$I_F = 20\text{ mA}$	SFH6156-1	t_{on}	-	3	-	μs
	$I_F = 10\text{ mA}$	SFH6156-2	t_{on}	-	4.2	-	μs
		SFH6156-3	t_{on}	-	4.2	-	μs
	$I_F = 5\text{ mA}$	SFH6156-4	t_{on}	-	6	-	μs
Rise time	$I_F = 20\text{ mA}$	SFH6156-1	t_r	-	2	-	μs
	$I_F = 10\text{ mA}$	SFH6156-2	t_r	-	3	-	μs
		SFH6156-3	t_r	-	3	-	μs
	$I_F = 5\text{ mA}$	SFH6156-4	t_r	-	4	-	μs
Turn-off time	$I_F = 20\text{ mA}$	SFH6156-1	t_{off}	-	18	-	μs
	$I_F = 10\text{ mA}$	SFH6156-2	t_{off}	-	23	-	μs
		SFH6156-3	t_{off}	-	23	-	μs
	$I_F = 5\text{ mA}$	SFH6156-4	t_{off}	-	25	-	μs
Fall time	$I_F = 20\text{ mA}$	SFH6156-1	t_f	-	11	-	μs
	$I_F = 10\text{ mA}$	SFH6156-2	t_f	-	14	-	μs
		SFH6156-3	t_f	-	14	-	μs
	$I_F = 5\text{ mA}$	SFH6156-4	t_f	-	15	-	μs

SAFETY AND INSULATION RATINGS				
PARAMETER	TEST CONDITION	SYMBOL	VALUE	UNIT
Climatic classification	According to IEC 68 part 1		55/100/21	
Comparative tracking index		CTI	175	
Maximum rated withstanding isolation voltage	t = 1 min	V_{ISO}	4420	V_{RMS}
Maximum transient isolation voltage		V_{IOTM}	10 000	V
Maximum repetitive peak isolation voltage		V_{IORM}	890	V
Isolation resistance	$V_{IO} = 500\text{ V}, T_{amb} = 25\text{ }^{\circ}\text{C}$	R_{IO}	$\geq 10^{12}$	Ω
	$V_{IO} = 500\text{ V}, T_{amb} = 100\text{ }^{\circ}\text{C}$	R_{IO}	$\geq 10^{11}$	Ω
Output safety power		P_{SO}	400	mW
Input safety current		I_{SI}	275	mA
Input safety temperature		T_{SI}	175	$^{\circ}\text{C}$
Creepage distance			≥ 7	mm
Clearance distance			≥ 7	mm
Insulation thickness		DTI	≥ 0.4	mm

Note

- As per IEC 60747-5-5, § 7.4.3.8.2, this optocoupler is suitable for “safe electrical insulation” only within the safety ratings. Compliance with the safety ratings shall be ensured by means of protective circuits

TYPICAL CHARACTERISTICS ($T_{amb} = 25\text{ }^{\circ}\text{C}$, unless otherwise specified)

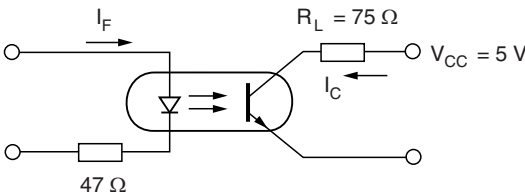

isfh615a_01

Fig. 2 - Linear Operation (without saturation)

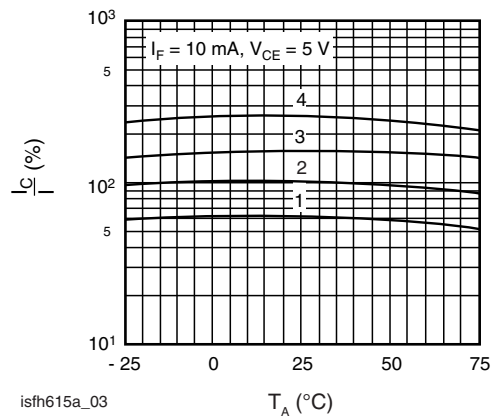

isfh615a_03

Fig. 4 - Current Transfer Ratio (typ.) vs. Temperature

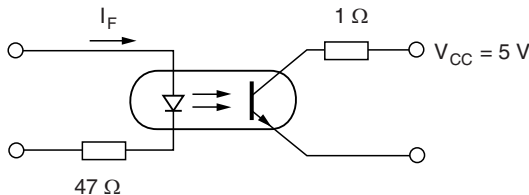

isfh615a_02

Fig. 3 - Switching Operation (with saturation)

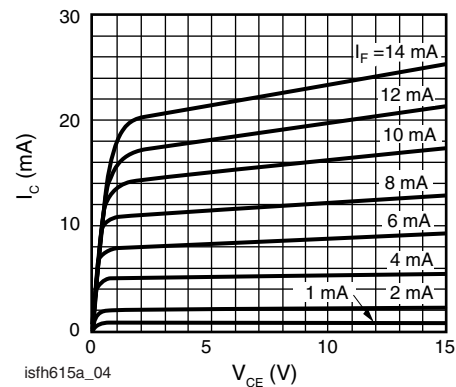

isfh615a_04

Fig. 5 - Output Characteristics (typ.) Collector Current vs. Collector Emitter Voltage

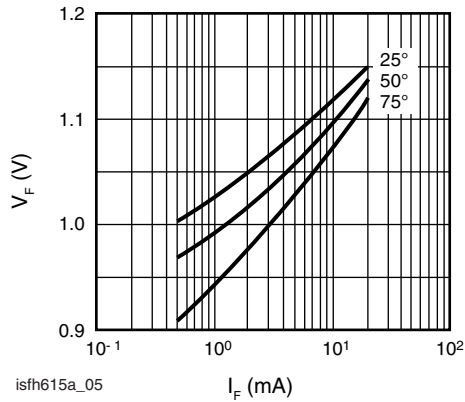

Fig. 6 - Diode Forward Voltage (typ.) vs. Forward Current

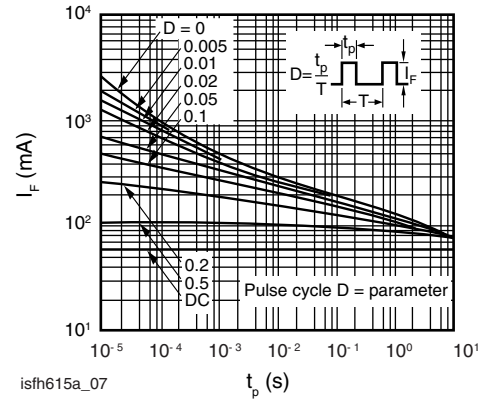

Fig. 8 - Permissible Pulse Handling Capability Forward Current vs. Pulse Width

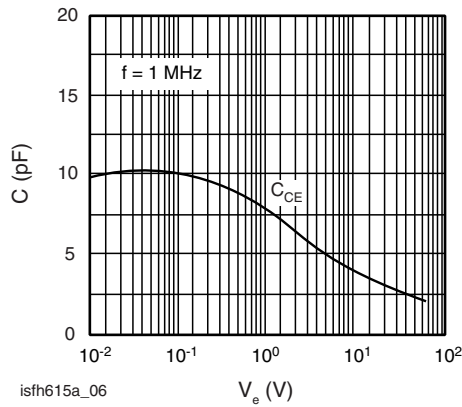
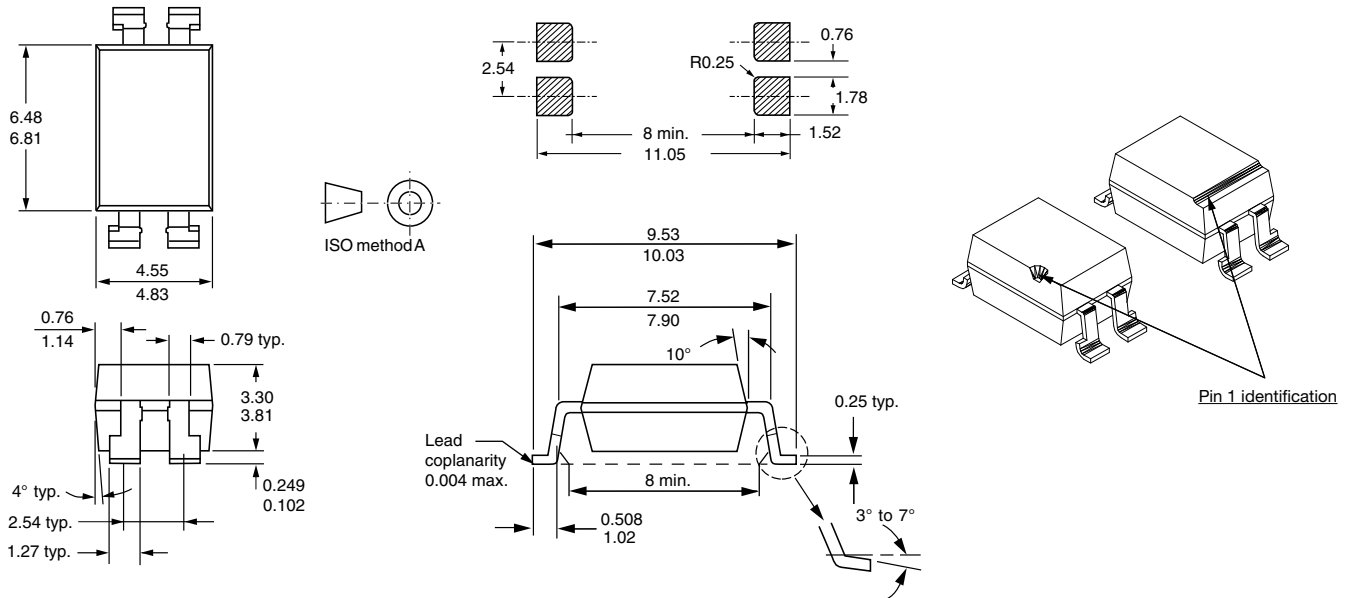
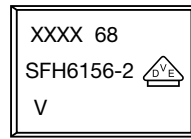

Fig. 7 - Transistor Capacitance (typ.) vs. Collector Emitter Voltage

PACKAGE DIMENSIONS (in millimeters)



PACKAGE MARKING (example of SFH6156-2X001T)



Notes

- XXXX = LMC (lot marking code)
- VDE logo is only marked on option 1 parts
- Tape and reel suffix (T) is not part of the package marking

TAPE AND REEL PACKAGING (in millimeters)

The tape is 16 mm and is wound on a 33 cm reel. There are 1000 parts per reel. Taped and reeled 4 pin optocouplers conform to EIA-481-2 and IEC60286-3.

SMD-4 (“T”)

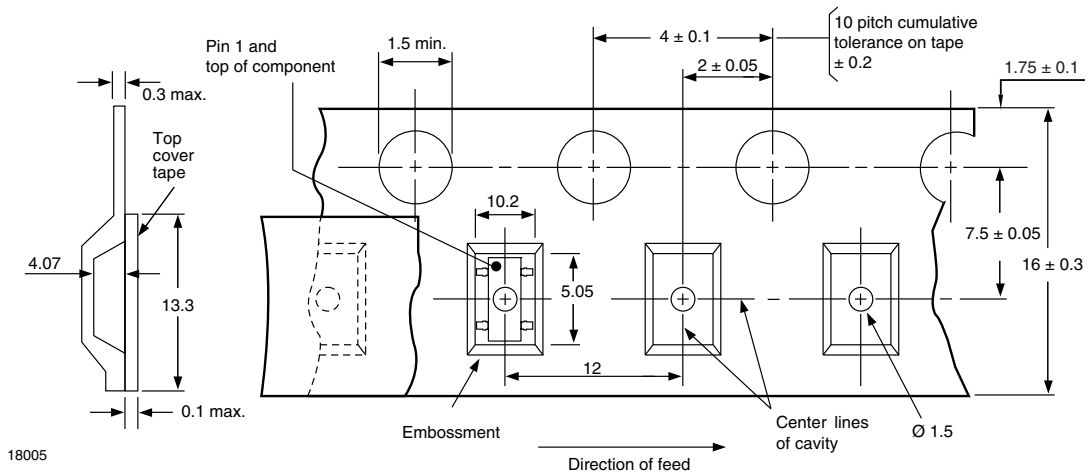

SMD-4, 90° Rotation (“T1”)

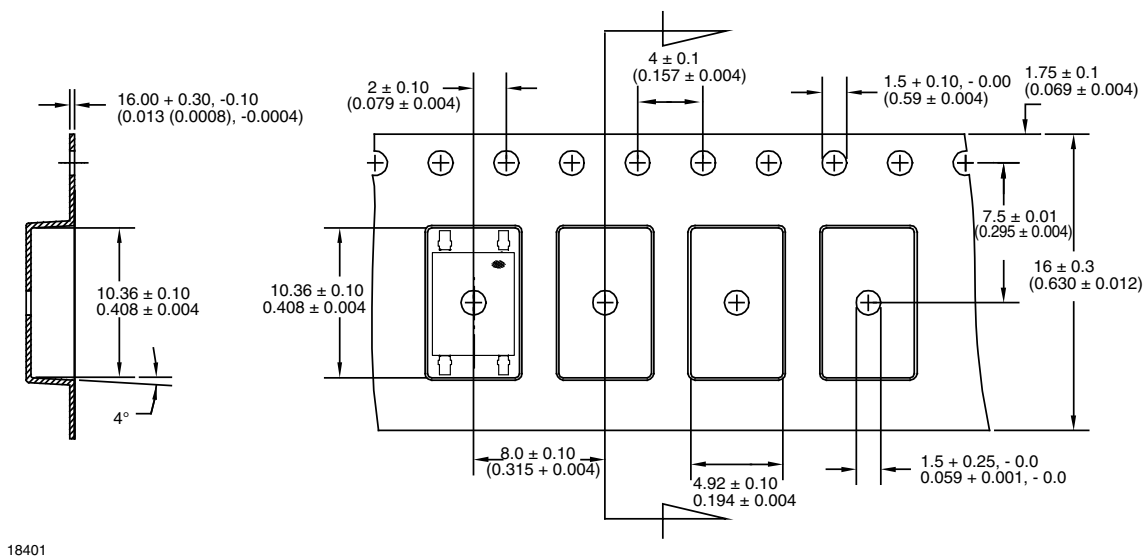

SOLDER PROFILES

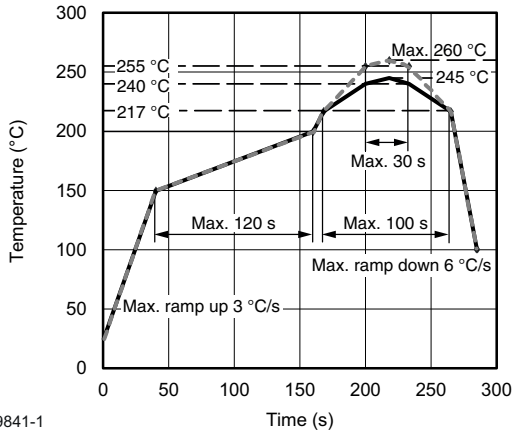

19841-1

Fig. 9 - Lead (Pb)-free Reflow Solder Profile According to J-STD-020 for SMD Devices

HANDLING AND STORAGE CONDITIONS

ESD level: HBM class 2

Floor life: unlimited

Conditions: $T_{amb} < 30\text{ °C}$, RH < 85 %

Moisture sensitivity level 1, according to J-STD-020



Disclaimer

ALL PRODUCT, PRODUCT SPECIFICATIONS AND DATA ARE SUBJECT TO CHANGE WITHOUT NOTICE TO IMPROVE RELIABILITY, FUNCTION OR DESIGN OR OTHERWISE.

Vishay Intertechnology, Inc., its affiliates, agents, and employees, and all persons acting on its or their behalf (collectively, "Vishay"), disclaim any and all liability for any errors, inaccuracies or incompleteness contained in any datasheet or in any other disclosure relating to any product.

Vishay makes no warranty, representation or guarantee regarding the suitability of the products for any particular purpose or the continuing production of any product. To the maximum extent permitted by applicable law, Vishay disclaims (i) any and all liability arising out of the application or use of any product, (ii) any and all liability, including without limitation special, consequential or incidental damages, and (iii) any and all implied warranties, including warranties of fitness for particular purpose, non-infringement and merchantability.

Statements regarding the suitability of products for certain types of applications are based on Vishay's knowledge of typical requirements that are often placed on Vishay products in generic applications. Such statements are not binding statements about the suitability of products for a particular application. It is the customer's responsibility to validate that a particular product with the properties described in the product specification is suitable for use in a particular application. Parameters provided in datasheets and / or specifications may vary in different applications and performance may vary over time. All operating parameters, including typical parameters, must be validated for each customer application by the customer's technical experts. Product specifications do not expand or otherwise modify Vishay's terms and conditions of purchase, including but not limited to the warranty expressed therein.

Hyperlinks included in this datasheet may direct users to third-party websites. These links are provided as a convenience and for informational purposes only. Inclusion of these hyperlinks does not constitute an endorsement or an approval by Vishay of any of the products, services or opinions of the corporation, organization or individual associated with the third-party website. Vishay disclaims any and all liability and bears no responsibility for the accuracy, legality or content of the third-party website or for that of subsequent links.

Except as expressly indicated in writing, Vishay products are not designed for use in medical, life-saving, or life-sustaining applications or for any other application in which the failure of the Vishay product could result in personal injury or death. Customers using or selling Vishay products not expressly indicated for use in such applications do so at their own risk. Please contact authorized Vishay personnel to obtain written terms and conditions regarding products designed for such applications.

No license, express or implied, by estoppel or otherwise, to any intellectual property rights is granted by this document or by any conduct of Vishay. Product names and markings noted herein may be trademarks of their respective owners.