

## Multi Chip LED

# SFH 7019

The SFH 7019 sets a new technological standard for optical sensors in wearables and digital health applications. As a compact 3-in-1 multi-chip LED, it combines a green, IR, and UV-A emitter in a single component, enabling the measurement of both classic vital parameters such as heart rate and the non-invasive determination of a new parameter, advanced glycation end products (AGEs).

Together with our SFH 2705U photodiode, it enables precise measuring of AGEs.

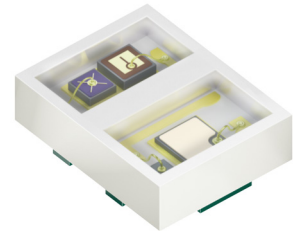

## Applications

- Digital diagnostic devices
- Vital sign monitoring

## Features

- Package: clear silicone
- ESD: 2 kV acc. to ANSI/ESDA/JEDEC JS-001 (HBM, Class 2)
- SMT package
- Suitable for SMT assembly
- Available on tape and reel
- Emitters can be controlled separately

---

## Ordering Information

Type	Ordering Code
SFH 7019	Q65115A2526)
● ultraviolet (UV-A)	$I_F = 20 \text{ mA}$ (Q65115A2526)
● true green	$I_F = 20 \text{ mA}$ (Q65115A2526)
● infrared	$I_F = 20 \text{ mA}$ (Q65115A2526)

## Maximum Ratings

Parameter	Symbol		Values	Values	Values
			● ultraviolet (UV-A)	● true green	● infrared
Operating temperature	$T_{op}$	min.	-40 °C	-40 °C	-40 °C
		max.	85 °C	85 °C	85 °C
Storage temperature	$T_{stg}$	min.	-40 °C	-40 °C	-40 °C
		max.	85 °C	85 °C	85 °C
Junction temperature	$T_j$	max.	100 °C	100 °C	100 °C
Forward current	$I_F$	max.		30 mA	60 mA
Forward current pulsed	$I_{F\ pulse}$	max.	50 mA	0.75 A	1 A
ESD withstand voltage acc. to ANSI/ESDA/JEDEC JS-001 (HBM, Class 2)	$V_{ESD}$	max.	2 kV	2 kV	2 kV

UV chip is not suitable for DC operation

## Characteristics

$I_F = 20 \text{ mA}$

Parameter	Symbol		Values	Values	Values
			● ultraviolet (UV-A)	● true green	● infrared
Peak wavelength	$\lambda_{\text{peak}}$	typ.	379 nm	527 nm	973 nm
Centroid wavelength <sup>1)</sup>	$\lambda_{\text{centroid}}$	min.	378 nm	522.5 nm	967 nm
		typ.	383 nm	530 nm	974 nm
		max.	387 nm	541.5 nm	985 nm
Spectral bandwidth at 50% $I_{\text{rel,max}}$ (FWHM)	$\Delta\lambda$	typ.	11 nm	32 nm	45 nm
Half angle	$\varphi$	typ.	60 °	60 °	60 °
Rise time (10% / 90%) $I_F = 50 \text{ mA}; R_L = 2 \Omega$	$t_r$	typ.	18 ns	68 ns	9 ns
Fall time (10% / 90%) $I_F = 50 \text{ mA}; R_L = 2 \Omega$	$t_f$	typ.	7 ns	40 ns	7 ns
Forward voltage <sup>2)</sup>	$V_F$	min.	3.0 V	2.2 V	1.1 V
		typ.	3.4 V	2.4 V	1.3 V
		max.	3.8 V	2.8 V	1.5 V
Reverse current <sup>3)</sup>	$I_R$	max.	10 $\mu\text{A}$	10 $\mu\text{A}$	10 $\mu\text{A}$
Radiant intensity <sup>4)5)</sup>	$I_e$	min.	5.0 mW/sr	2.2 mW/sr	1.8 mW/sr
		typ.	5.9 mW/sr	4.1 mW/sr	2.4 mW/sr
		max.	6.8 mW/sr	5.4 mW/sr	3.4 mW/sr
Total radiant flux <sup>6)</sup>	$\Phi_e$	typ.	18 mW	14 mW	8 mW
Thermal resistance junction solder point real <sup>7)</sup>	$R_{\text{thJS real}}$	typ.	100 K / W	240 K / W	160 K / W
		max.	120 K / W	290 K / W	190 K / W

UV is not suitable for DC operation.

### Relative Spectral Emission 8), 9)

- ultraviolet (UV-A):  $I_{e,rel} = f(\lambda)$ ;  $I_F = 20 \text{ mA}$ ;  $t_p = 20 \text{ ms}$

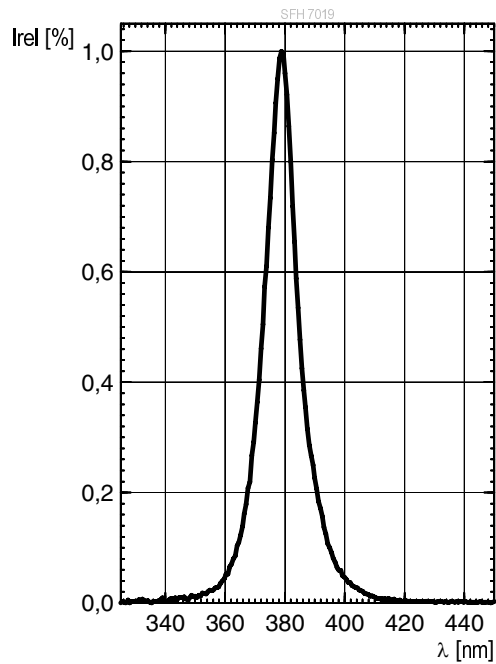

### Relative Spectral Emission 8), 9)

- true green:  $I_{e,rel} = f(\lambda)$ ;  $I_F = 20 \text{ mA}$ ;  $t_p = 20 \text{ ms}$

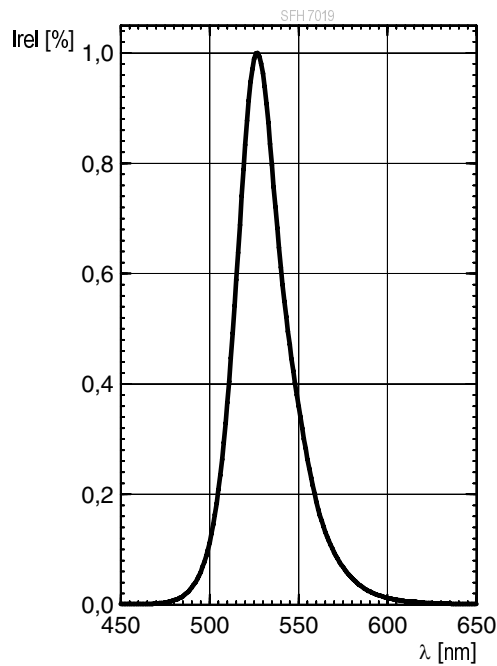

## Relative Spectral Emission <sup>8), 9)</sup>

- infrared:  $I_{e,rel} = f(\lambda)$ ;  $I_F = 20 \text{ mA}$ ;  $t_p = 20 \text{ ms}$

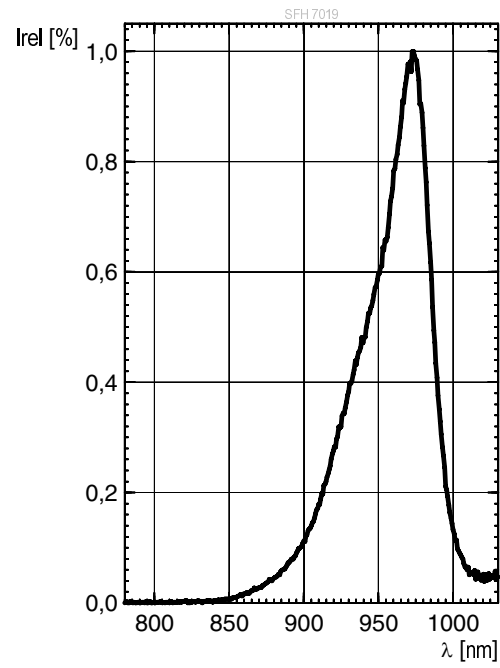

### Radiation Characteristics <sup>8), 9)</sup>

ultraviolet / true green / infrared:  $I_{rel} = f(\phi)$

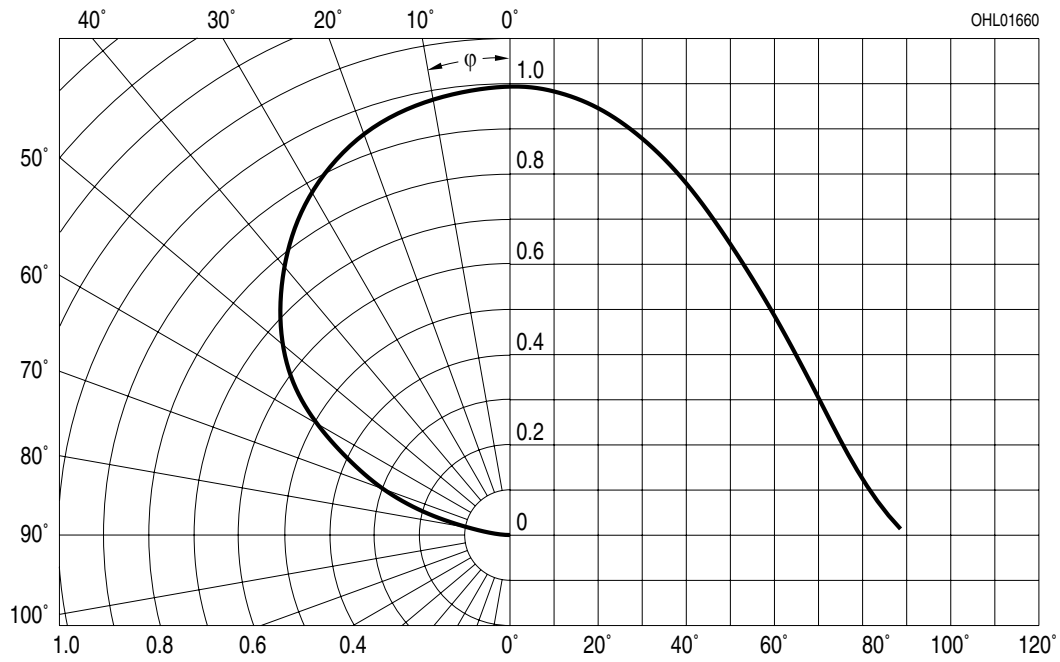

**Forward current** 8), 9)

- ultraviolet (UV-A):  $I_F = f(V_F); t_p = 100 \mu s$

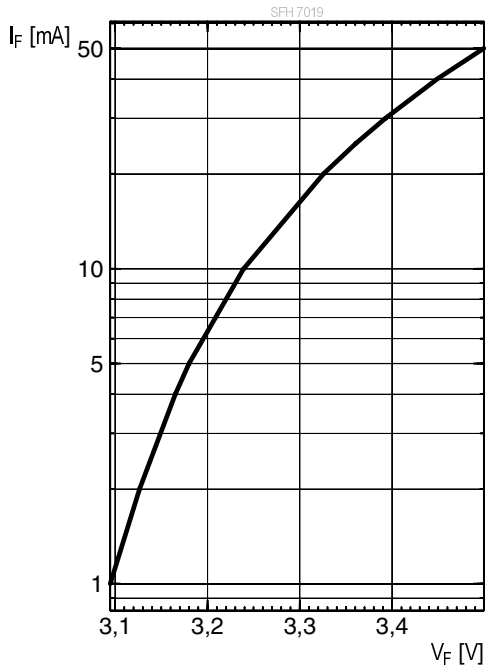

**Forward current** 8), 9)

- true green:  $I_F = f(V_F); t_p = 100 \mu s$

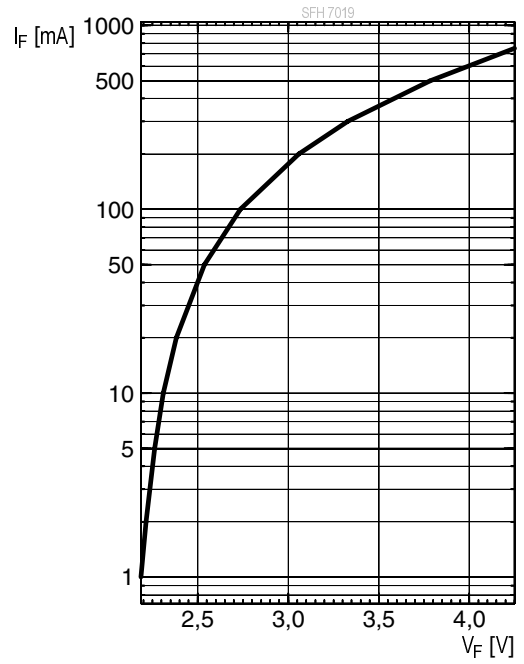

**Forward current** 8), 9)

- infrared:  $I_F = f(V_F); t_p = 100 \mu s$

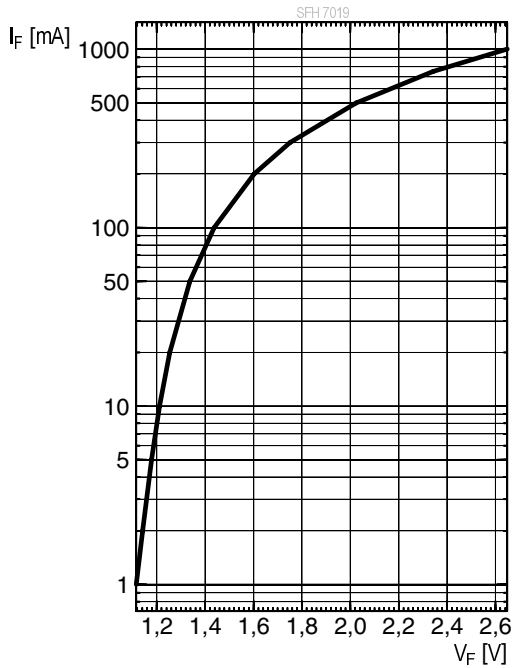



### Relative Radiant Intensity <sup>8), 9)</sup>

- ultraviolet (UV-A):  $I_e/I_{e(20\text{mA})} = f(I_F)$ ;  $t_p = 100 \mu\text{s}$

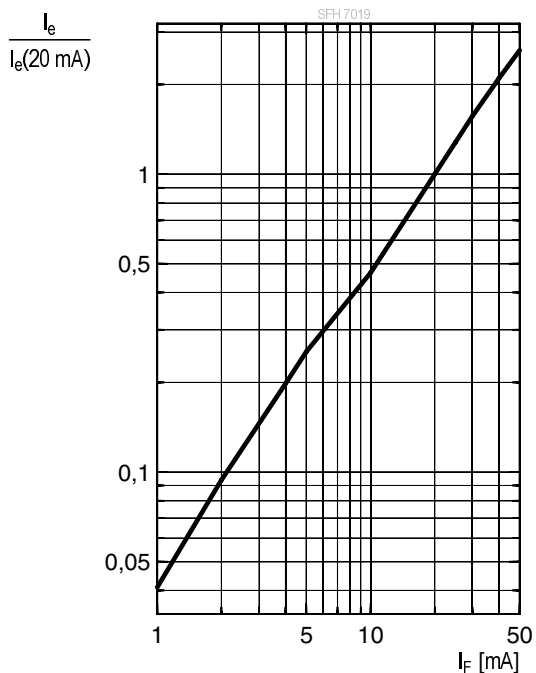

### Relative Radiant Intensity <sup>8), 9)</sup>

- true green:  $I_e/I_{e()} = f(I_F)$ ;  $t_p = 100 \mu\text{s}$

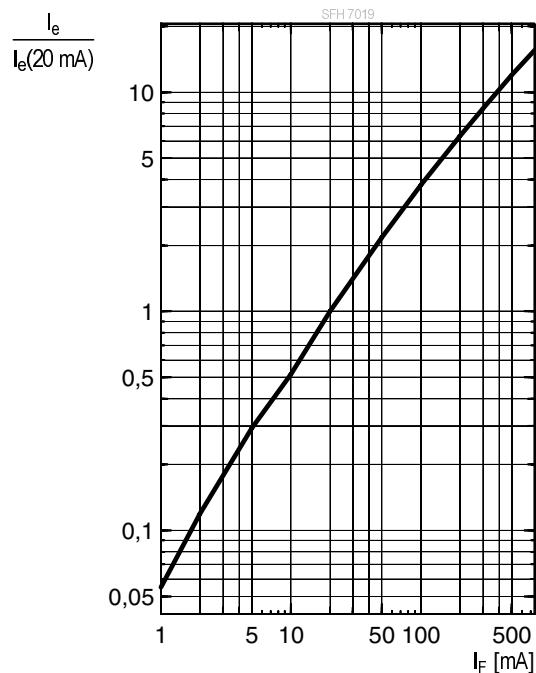

### Relative Radiant Intensity <sup>8), 9)</sup>

- infrared:  $I_e/I_{e()} = f(I_F)$ ;  $t_p = 100 \mu\text{s}$

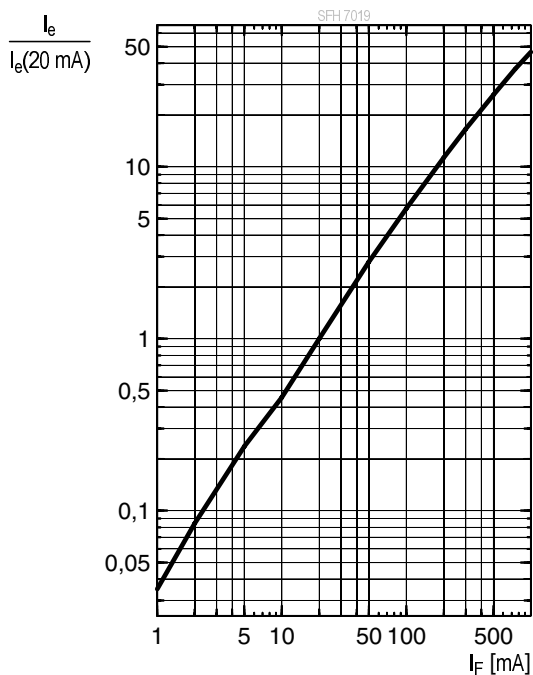

**Forward Voltage** <sup>8)</sup>

- ultraviolet (UV-A):  $V_F = f(T_S)t_p = 20\text{ms}$ ; single pulse

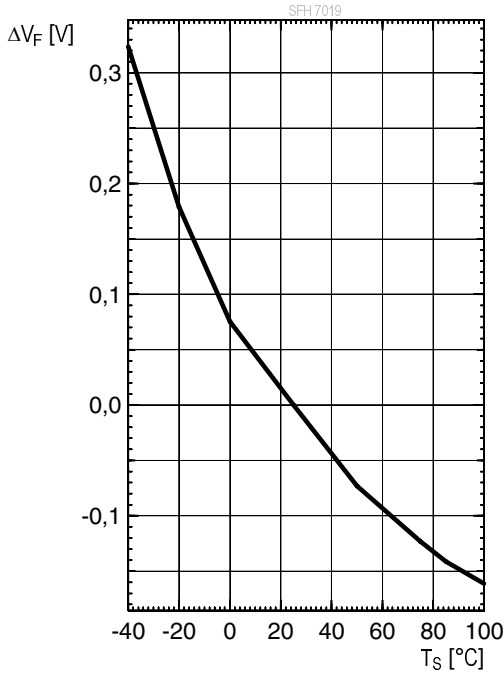

**Forward Voltage** <sup>8)</sup>

- true green:  $V_F = f(T_S)t_p = 20\text{ms}$ ; single pulse

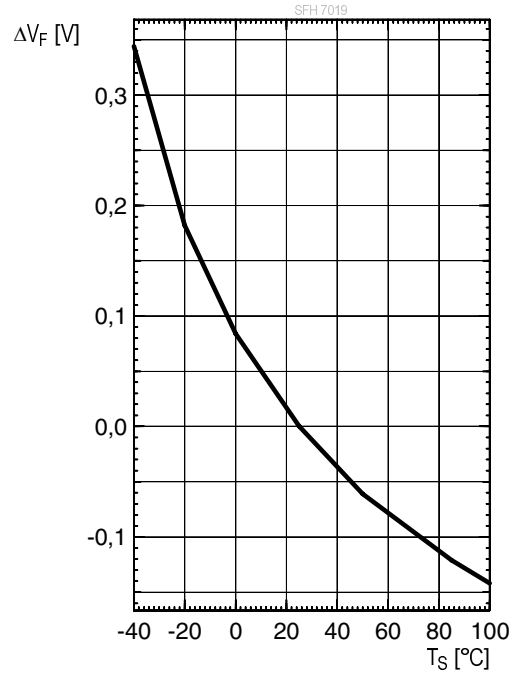

**Forward Voltage** <sup>8)</sup>

- infrared:  $V_F = f(T_S)t_p = 20\text{ms}$ ; single pulse

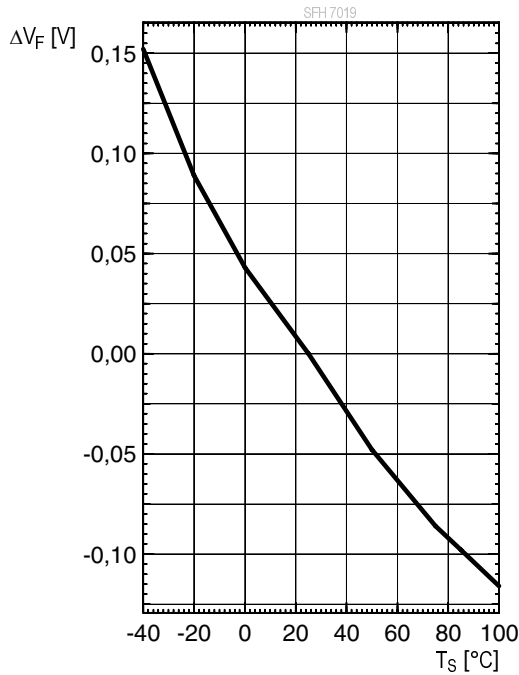

**Relative Radiant Intensity** <sup>8)</sup>

- ultraviolet (UV-A):  $I_{e,rel} = f(T_s)t_p = 20\text{ms}$ ; single pulse

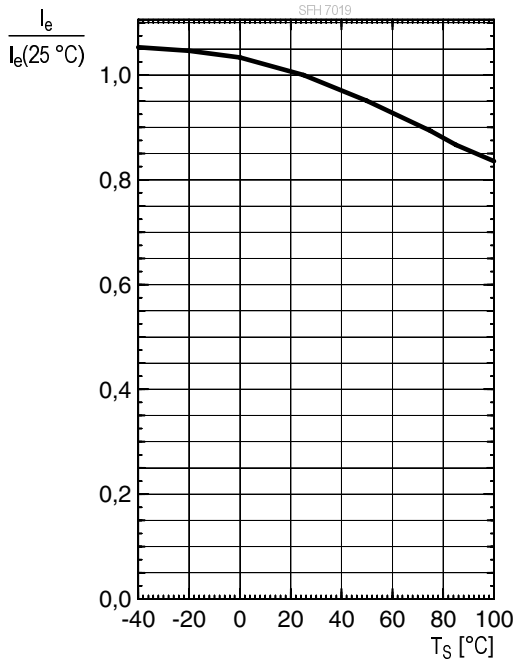

**Relative Radiant Intensity** <sup>8)</sup>

- true green:  $I_{e,rel} = f(T_s)t_p = 20\text{ms}$ ; single pulse

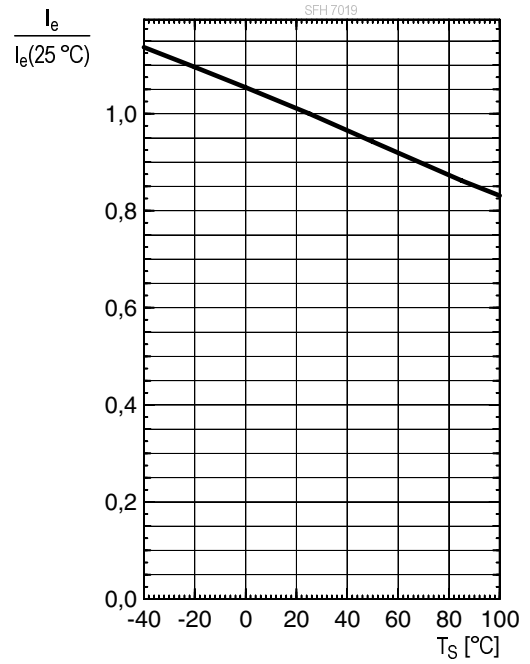

**Relative Radiant Intensity** <sup>8)</sup>

- infrared:  $I_{e,rel} = f(T_s)t_p = 20\text{ms}$ ; single pulse

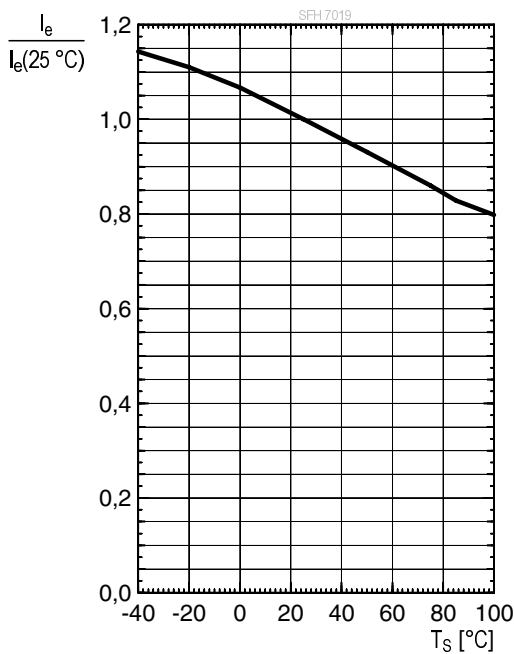

### Centroid Wavelength <sup>8)</sup>

- ultraviolet (UV-A):  $\lambda_{\text{centroid}} = f(T_s)$ ;  $t_p = 20\text{ms}$ ; single pulse

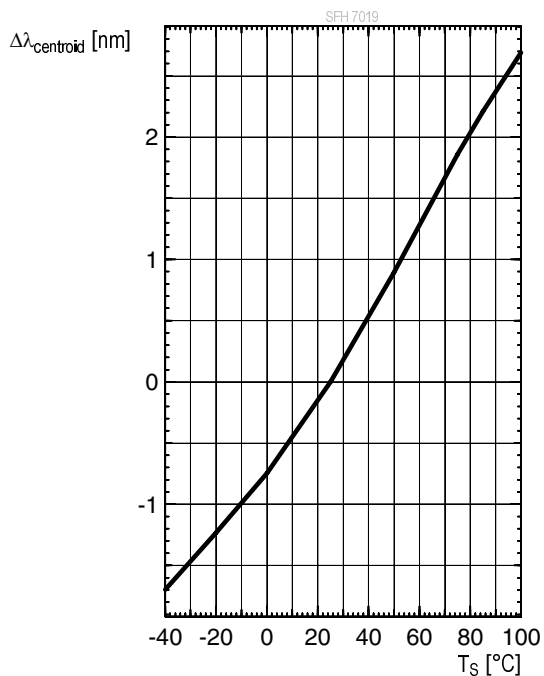

### Centroid Wavelength <sup>8)</sup>

- true green:  $\lambda_{\text{centroid}} = f(T_s)$ ;  $t_p = 20\text{ms}$ ; single pulse

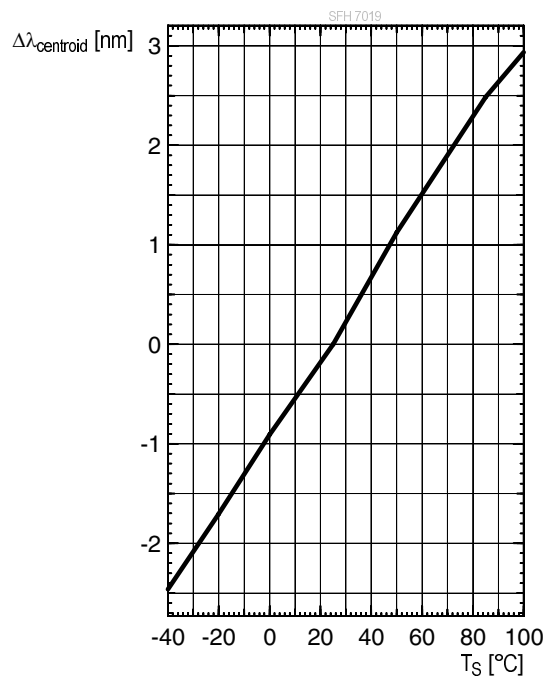

### Centroid Wavelength <sup>8)</sup>

- infrared:  $\lambda_{\text{centroid}} = f(T_s)$ ;  $t_p = 20\text{ms}$ ; single pulse

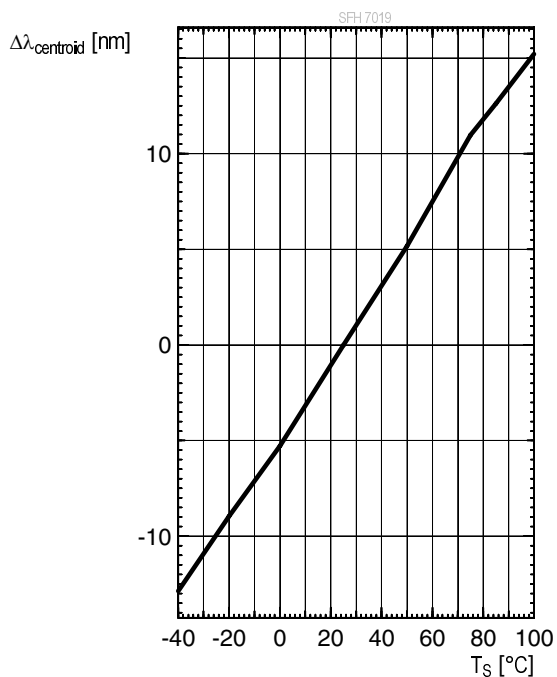

### Max. Permissible Forward Current

- ultraviolet (UV-A):  $I_F = f(T_S)$ ;  $R_{th_{js}} = 120 \text{ K/W}$

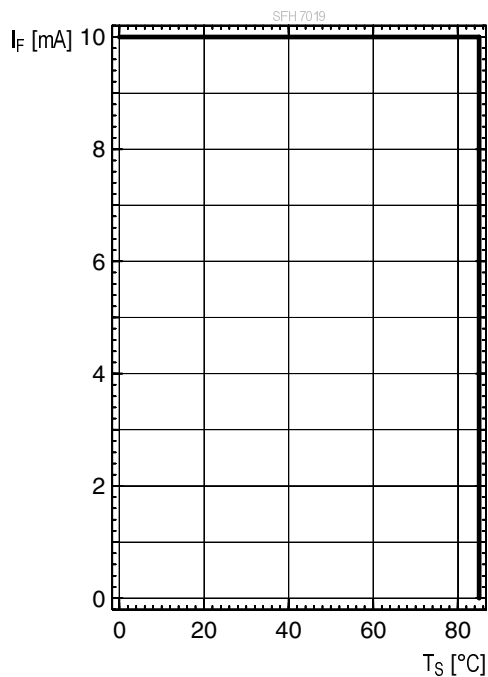

### Max. Permissible Forward Current

- true green:  $I_F = f(T_S)$ ;  $R_{th_{js}} = 290 \text{ K/W}$

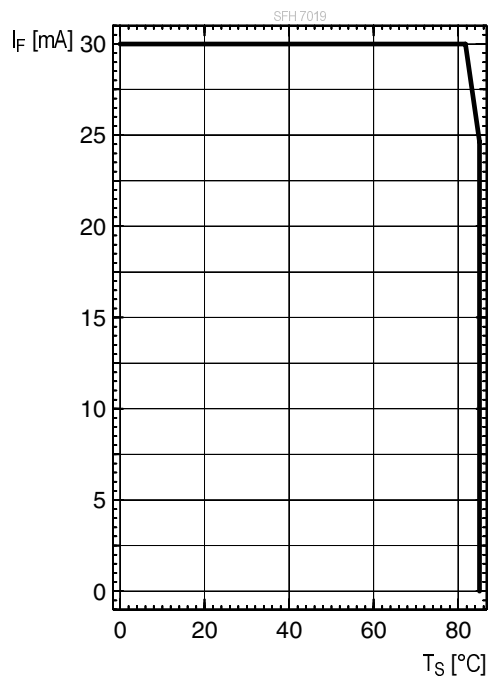

### Max. Permissible Forward Current

- infrared:  $I_F = f(T_S)$ ;  $R_{th_{js}} = 190 \text{ K/W}$

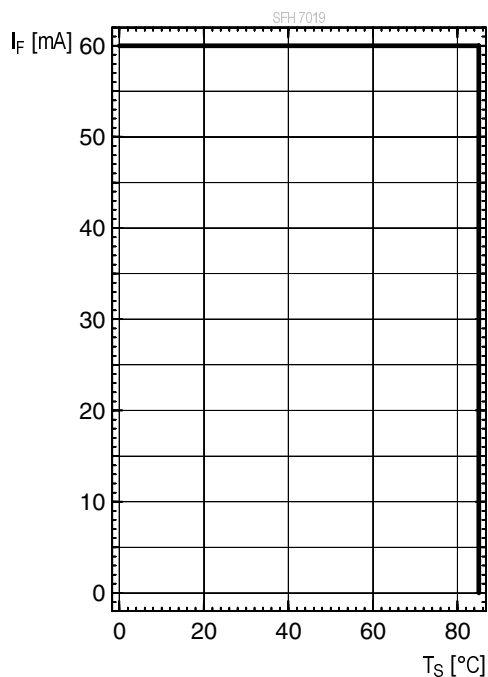

**Permissible Pulse Handling Capability**

• true green:  $I_F = f(t_p)$ ;  $D = \text{parameter}$ ;  $T_s = 25\text{ }^\circ\text{C}$

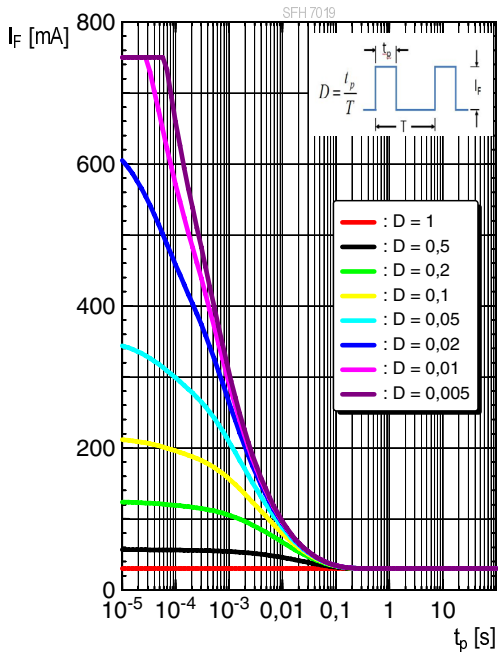

**Permissible Pulse Handling Capability**

• true green:  $I_F = f(t_p)$ ;  $D = \text{parameter}$ ;  $T_s = 85\text{ }^\circ\text{C}$

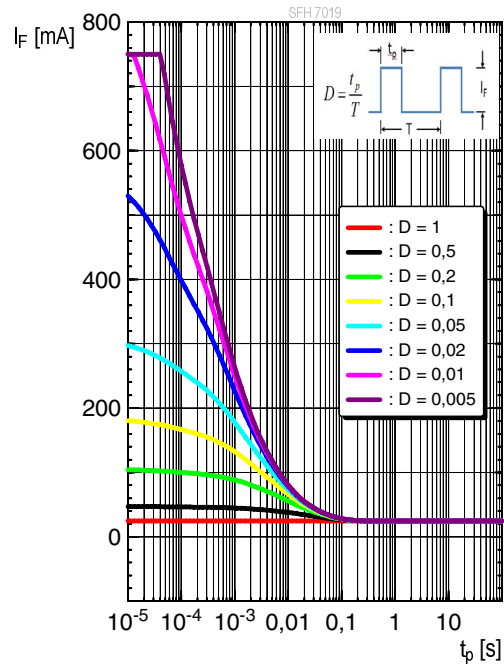

**Permissible Pulse Handling Capability**

• ultraviolet (UV-A):  $I_F = f(t_p)$ ;  $D = \text{parameter}$ ;  $T_s = 85\text{ }^\circ\text{C}$

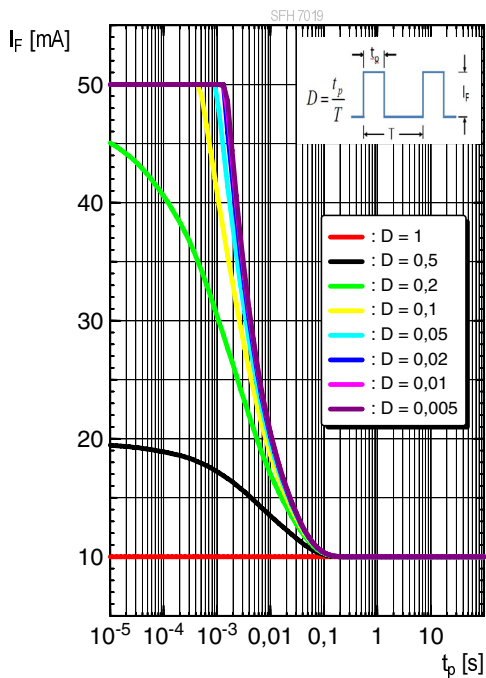

**Permissible Pulse Handling Capability**

• infrared:  $I_F = f(t_p)$ ;  $D = \text{parameter}$ ;  $T_s = 85\text{ }^\circ\text{C}$

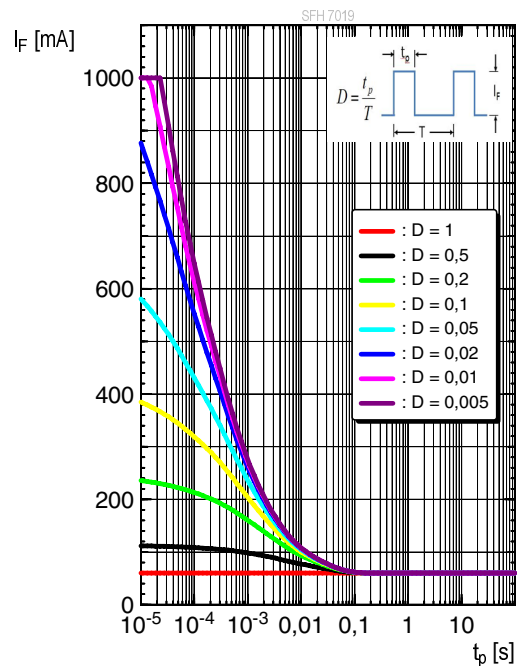

Dimensional Drawing <sup>10)</sup>

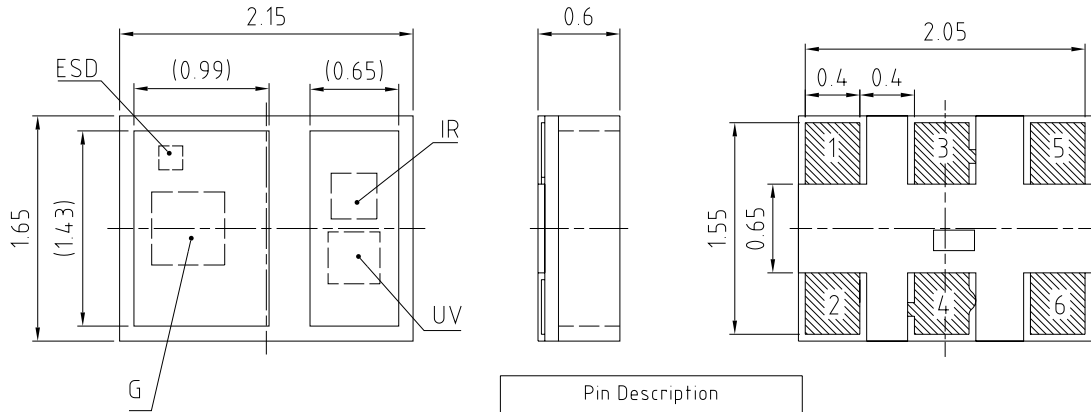

general tolerance  $\pm 0.1$   
lead finish Au

Pin Description	
1	IR (Cathode)
2	IR, UV (Anode)
3	G (Cathode)
4	UV (Cathode)
5	IR, UV (Anode)
6	G (Anode)

E067.0974.02 -02

Dimensional Drawing <sup>10)</sup>

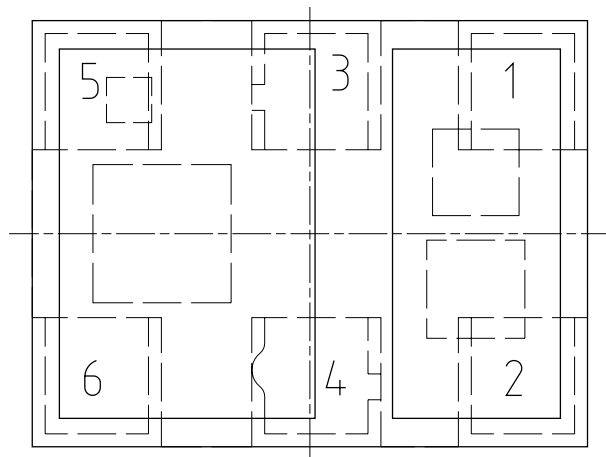

View from top side

Pin Description	
1	IR (Cathode)
2	IR, UV (Anode)
3	G (Cathode)
4	UV (Cathode)
5	IR, UV (Anode)
6	G (Anode)

### Electrical Internal Circuit

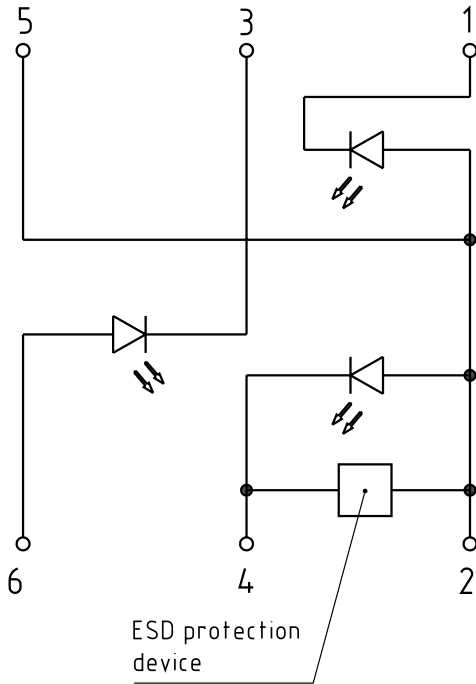

### Recommended Solder Pad <sup>10)</sup>

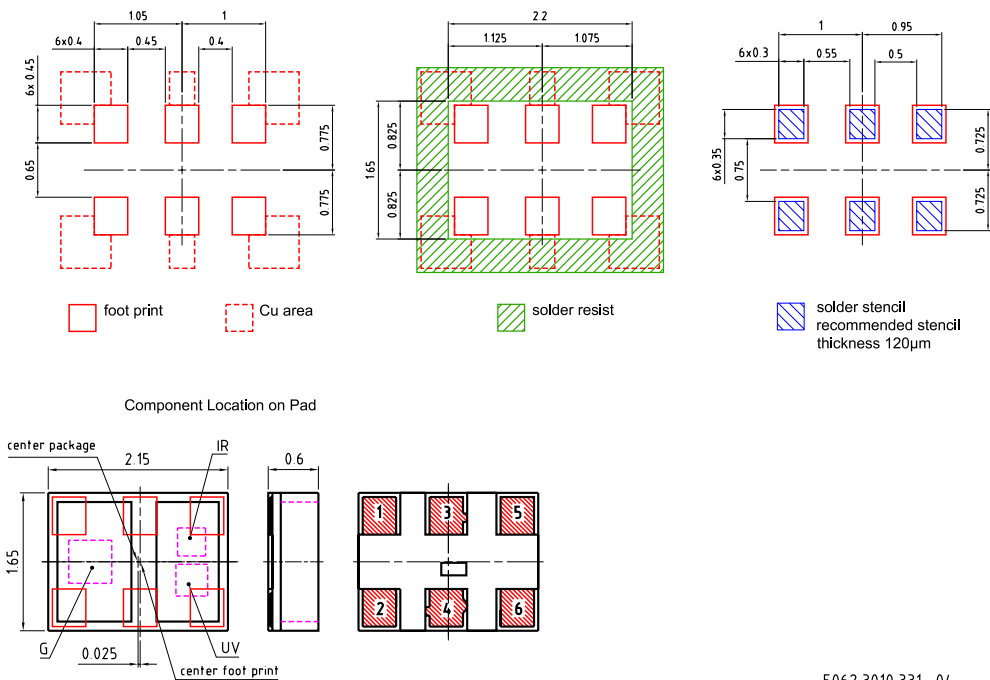

E062.3010.331-04

For superior solder joint connectivity results we recommend soldering under standard nitrogen atmosphere.



## Reflow Soldering Profile

Product complies to MSL Level 3 acc. to JEDEC J-STD-020E

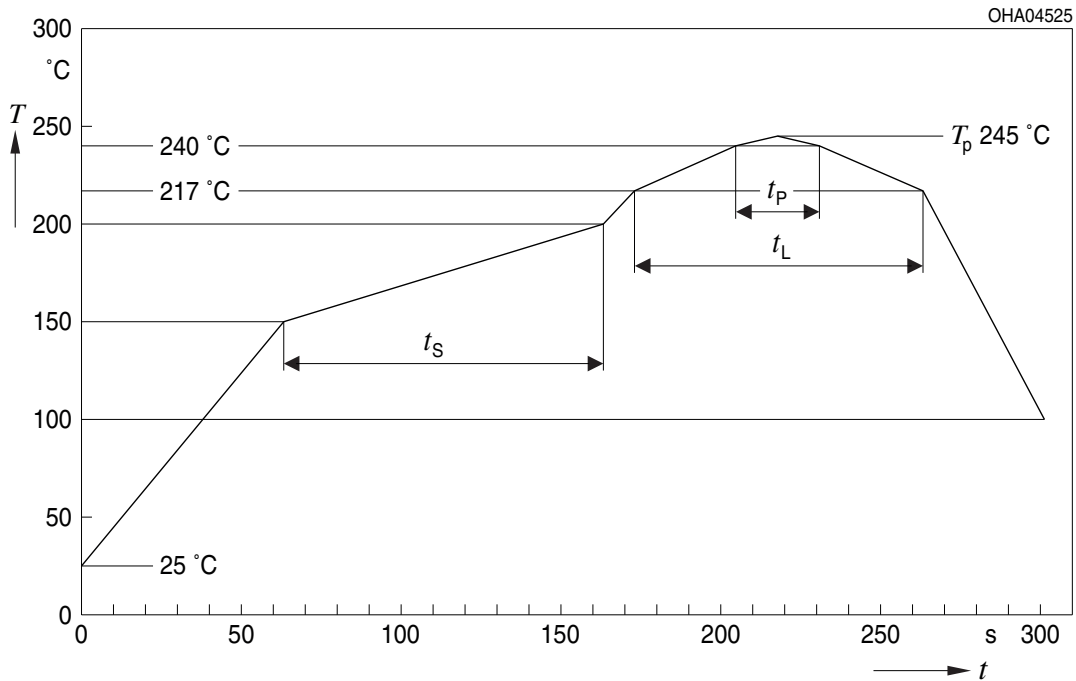

Profile Feature	Symbol	Pb-Free (SnAgCu) Assembly			Unit
		Minimum	Recommendation	Maximum	
Ramp-up rate to preheat <sup>*)</sup> 25 °C to 150 °C			2	3	K/s
Time $t_s$ $T_{Smin}$ to $T_{Smax}$	$t_s$	60	100	120	s
Ramp-up rate to peak <sup>*)</sup> $T_{Smax}$ to $T_p$			2	3	K/s
Liquidus temperature	$T_L$		217		°C
Time above liquidus temperature	$t_L$		80	100	s
Peak temperature	$T_p$		245	260	°C
Time within 5 °C of the specified peak temperature $T_p - 5$ K	$t_p$	10	20	30	s
Ramp-down rate* $T_p$ to 100 °C			3	6	K/s
Time 25 °C to $T_p$				480	s

All temperatures refer to the center of the package, measured on the top of the component

\* slope calculation  $DT/Dt$ :  $Dt$  max. 5 s; fulfillment for the whole T-range

**Tape and Reel** <sup>11)</sup>

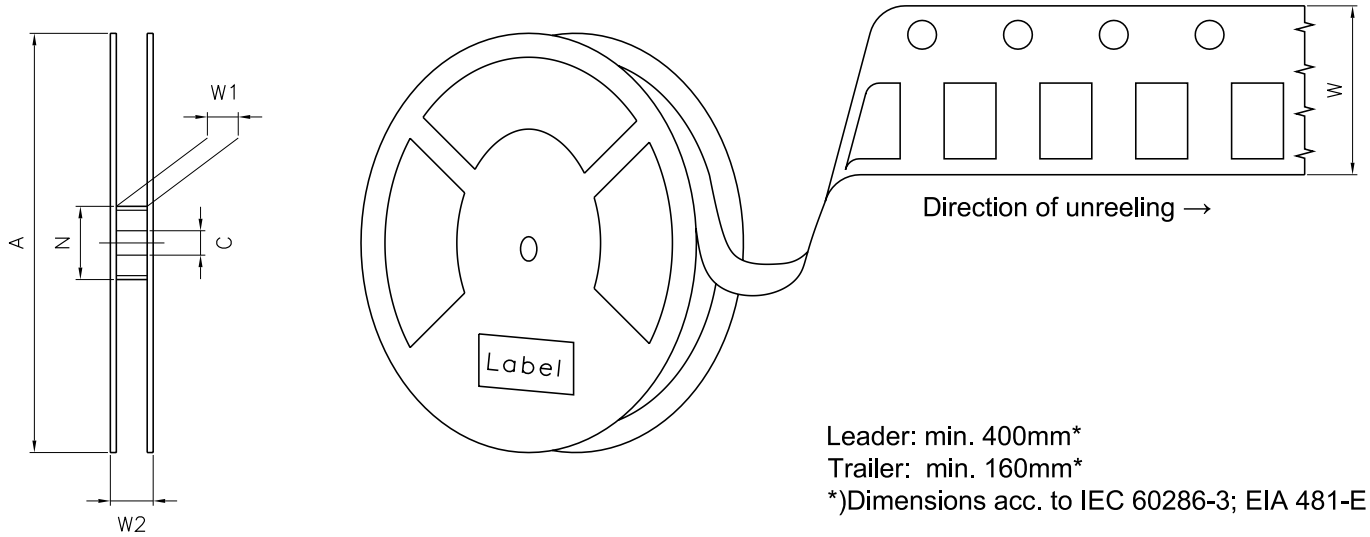

**Reel Dimensions**

A	W	$N_{\min}$	$W_1$	$W_{2\max}$	Pieces per PU
180 mm	$8 + 0.3 / - 0.1$ mm	60 mm	$8.4 + 2$ mm	14.4 mm	3000

**Barcode-Product-Label (BPL)**

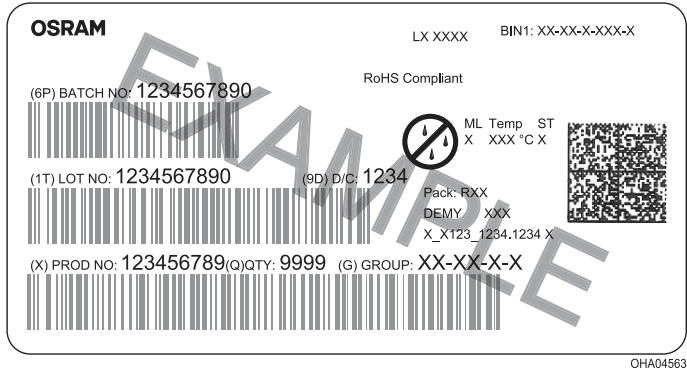

**Dry Packing Process and Materials** <sup>10)</sup>

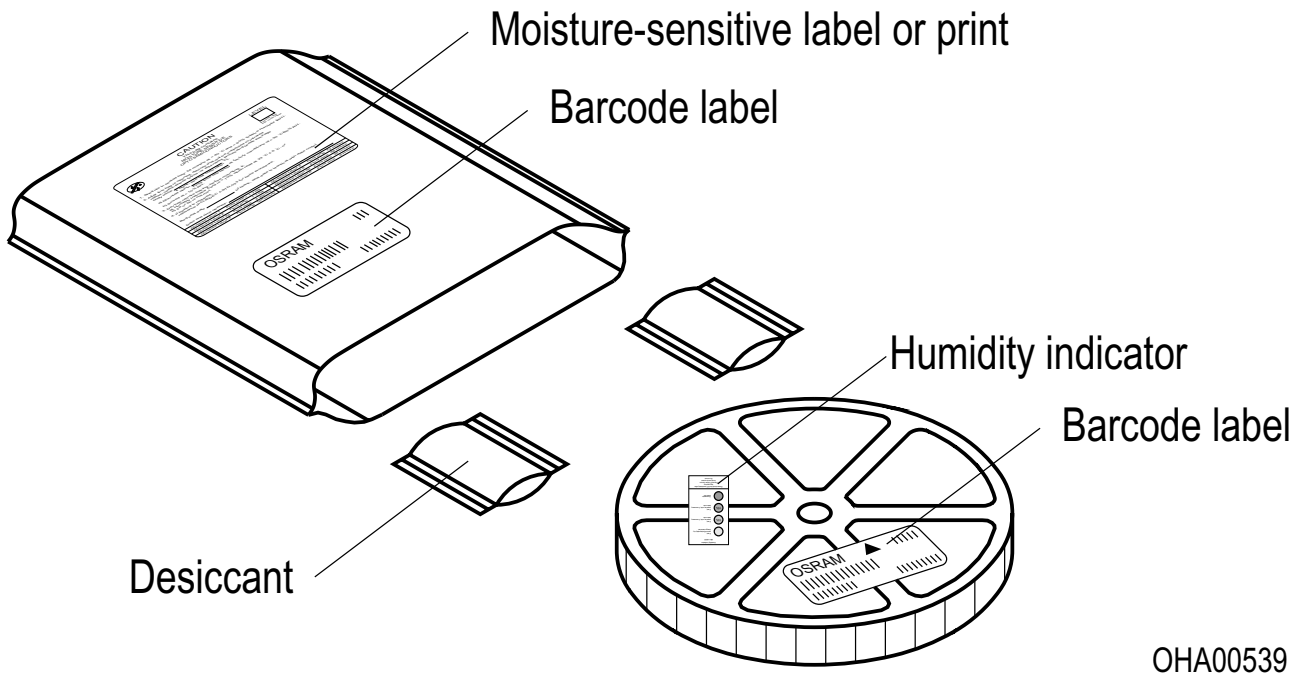

## Notes

The evaluation of eye safety occurs according to the standard IEC 62471:2006 (photo biological safety of lamps and lamp systems). Within the risk grouping system of this IEC standard, the device specified in this data sheet falls into **exempt risk group - Exempt**.

Subcomponents of this device contain, in addition to other substances, metal filled materials including silver. Metal filled materials can be affected by environments that contain traces of aggressive substances. Therefore, we recommend that customers minimize device exposure to aggressive substances during storage, production, and use. Devices that showed visible discoloration when tested using the described tests above did show no performance deviations within failure limits during the stated test duration. Respective failure limits are described in the IEC60810.

For further application related information please visit <https://ams-osram.com/support/application-notes>

## Disclaimer

### Attention please!

The information describes the type of component and shall not be considered as assured characteristics. Terms of delivery and rights to change design reserved. Due to technical requirements components may contain dangerous substances.

For information on the types in question please contact our Sales Organization.

If printed or downloaded, please find the latest version on our website.

### Packing

Please use the recycling operators known to you. We can also help you – get in touch with your nearest sales office. By agreement we will take packing material back, if it is sorted. You must bear the costs of transport. For packing material that is returned to us unsorted or which we are not obliged to accept, we shall have to invoice you for any costs incurred.

### Product and functional safety devices/applications or medical devices/applications

Our components are not developed, constructed or tested for the application as safety relevant component or for the application in medical devices.

Our products are not qualified at module and system level for such application.

In case buyer – or customer supplied by buyer – considers using our components in product safety devices/ applications or medical devices/applications, buyer and/or customer has to inform our local sales partner immediately and we and buyer and /or customer will analyze and coordinate the customer-specific request between us and buyer and/or customer.

---

## Glossary

- 1) **Wavelength:** The wavelengths are measured with a tolerance of  $\pm 1$  nm.
- 2) **Forward Voltage:** The forward voltages are measured with a tolerance of  $\pm 0.1$  V.
- 3) **Reverse Operation:** This product is intended to be operated applying a forward current within the specified range. Applying any continuous reverse bias or forward bias below the voltage range of light emission shall be avoided because it may cause migration which can change the electro-optical characteristics or damage the LED.
- 4) **Radiant intensity:** Measured at a solid angle of  $\Omega = 0.01$  sr
- 5) **Brightness:** The brightness values are measured with a tolerance of  $\pm 11\%$ .
- 6) **Total radiant flux:** Measured with integrating sphere.
- 7) **Thermal resistance:** junction - soldering point, of the device only, mounted on an ideal heatsink (e.g. metal block)
- 8) **Typical Values:** Due to the special conditions of the manufacturing processes of semiconductor devices, the typical data or calculated correlations of technical parameters can only reflect statistical figures. These do not necessarily correspond to the actual parameters of each single product, which could differ from the typical data and calculated correlations or the typical characteristic line. If requested, e.g. because of technical improvements, these typ. data will be changed without any further notice.
- 9) **Testing temperature:** TA = 25°C (unless otherwise specified)
- 10) **Tolerance of Measure:** Unless otherwise noted in drawing, tolerances are specified with  $\pm 0.1$  and dimensions are specified in mm.
- 11) **Tape and Reel:** All dimensions and tolerances are specified acc. IEC 60286-3 and specified in mm.

---

## Revision History

Version	Date	Change
1.0	2026-02-02	Initial Version

---



EU RoHS and China RoHS compliant product

此产品符合欧盟 RoHS 指令的要求；  
按照中国的相关法规和标准，  
不含有毒有害物质或元素。

**Published by ams-OSRAM AG**

Tobelbader Strasse 30, 8141 Premstaetten, Austria

Phone +43 3136 500-0

[ams-osram.com](http://ams-osram.com)

© All rights reserved

**am** 

**OSRAM**