

Ultrafast Recovery Power Rectifier

Features and Benefits

- Low forward drop voltage
- Dual common anode rectifier construction
- Ultrafast recovery time and high speed switching
- Full lead (Pb)-free device and RoHS compliant device

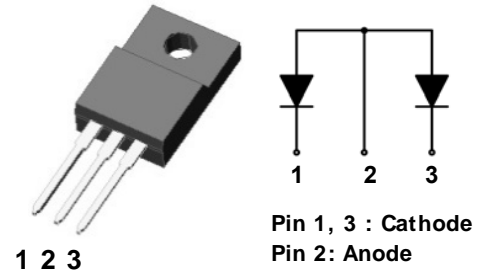

Applications

- Switching power supply
- Power inverters
- Power conversion system

TO-220F-3L

General Description

The SFN10A200R is ideally as boost diode in discontinuous or critical mode power factor corrections. The planar structure and the platinum doper life time control guarantee the best overall performance, ruggedness reliability characteristics. The device is also intended for use as a freewheeling diode in power supplies and other power switching applications.

Ordering Information

Part Number	Marking Code	Package	Packaging
SFN10A200R	SFN10A200R	TO-220F-3L	Tube

Marking Information

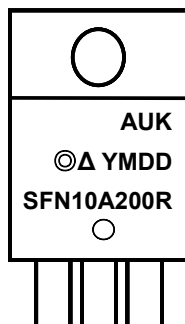

Column 1: Manufacturer

Column 2: Production Information

e.g.) ◎△YMDD

- ◎△: Factory Management Code

- YMDD: Date Code (Year, Month, Daily)

Column 3: Device Code

SFN10A200R

Absolute Maximum Ratings (Limiting values at 25°C, unless otherwise specified)

Characteristic		Symbol	Ratings	Unit
Maximum repetitive reverse voltage Maximum working peak reverse voltage Maximum DC blocking voltage		V_{RRM} V_{RWM} V_R	200	V
Maximum average forward rectified current	Per diode	$I_{F(AV)}$	5	A
	Total device		10	
Peak forward surge current 8.3ms single half sine-wave superimposed on rated load per diode		I_{FSM}	120	A
Storage temperature range		T_{stg}	-45 to +150	°C
Maximum operating junction temperature		T_J	150	

Thermal Characteristics (Per diode)

Characteristic	Symbol	Ratings	Unit
Maximum thermal resistance	$R_{th(J-C)}$	4.0	°C/W
	$R_{th(J-A)}$	62.5	

Electrical Characteristics (Per diode)

Characteristic	Symbol	Test Condition		Min.	Typ.	Max.	Unit
Peak forward voltage drop	$V_{FM}^{1)}$	$I_{FM} = 5A$	$T_J = 25^\circ C$	-	0.88	0.98	V
Reverse leakage current	$I_{RM}^{2)}$	$V_R = V_{RRM}$	$T_J = 25^\circ C$	-	-	5	uA
			$T_J = 125^\circ C$	-	-	200	
Reverse recovery time	t_{rr}	$I_F = 1A, di/dt = -100 A/us$		-	17	25	ns
Junction capacitance	C_j	$V_R = 10V_{DC}, f=1MHz$		-	32	-	pF

¹⁾ Pulse test: $t_p \leq 380us$, Duty cycle $\leq 2\%$

²⁾ Pulse test: $t_p \leq 20ms$, Duty cycle $\leq 2\%$

Typical Electrical Characteristic Curves (Per diode)

Fig. 1) Typical Forward Characteristics

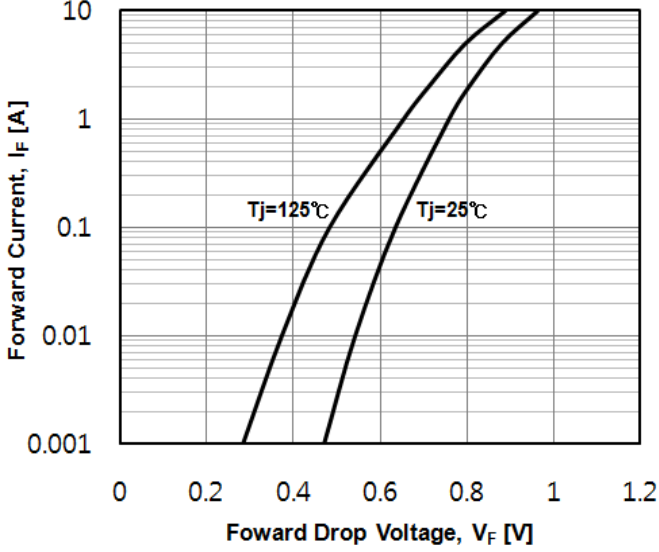

Fig. 2) Typical Reverse Characteristics

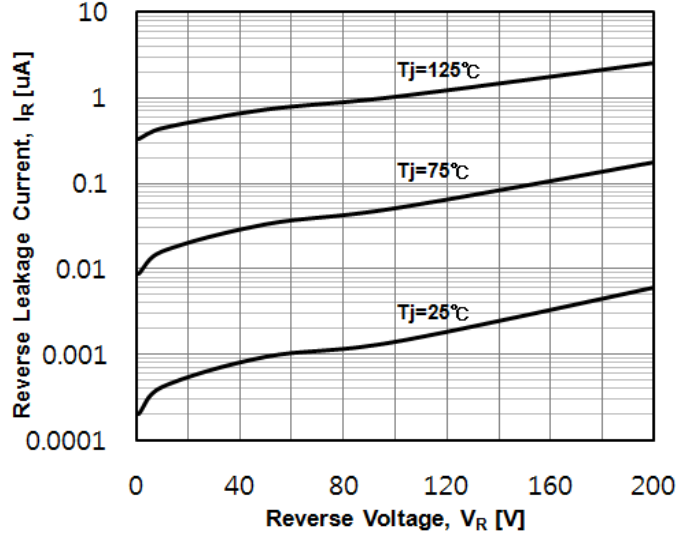

Fig. 3) Typical Junction Capacitance Characteristics

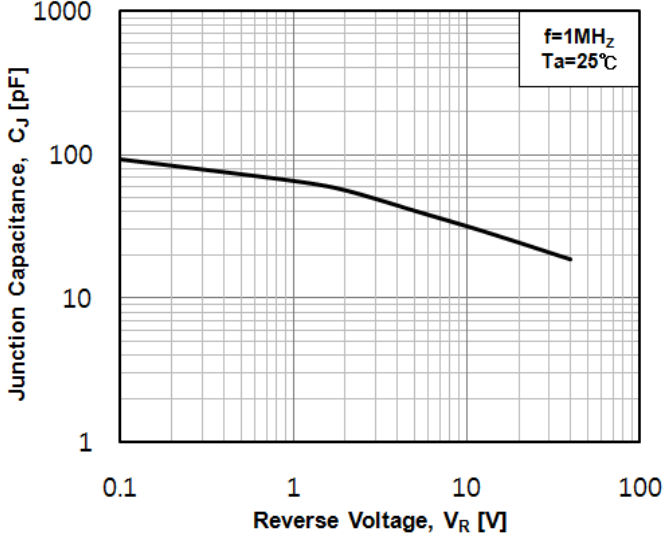

Fig. 4) Peak Forward Surge Current Characteristics

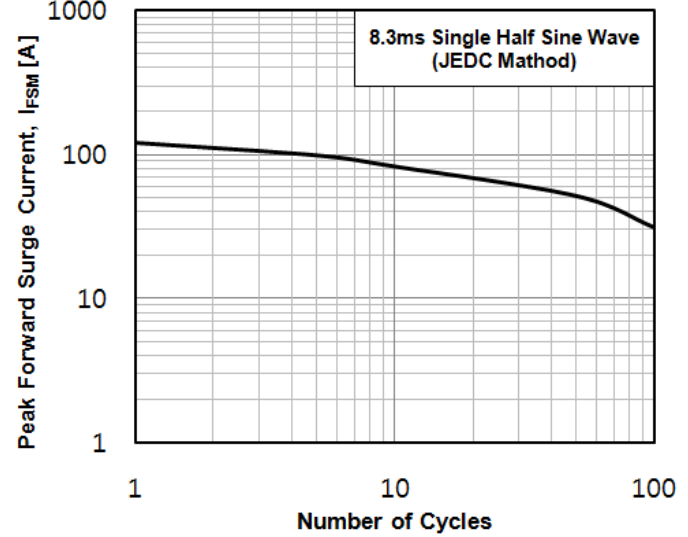

Fig. 5) Thermal Impedance Characteristics

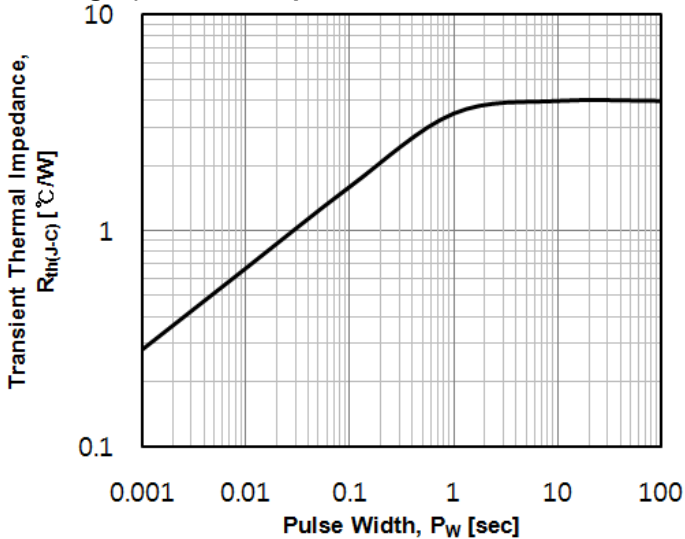
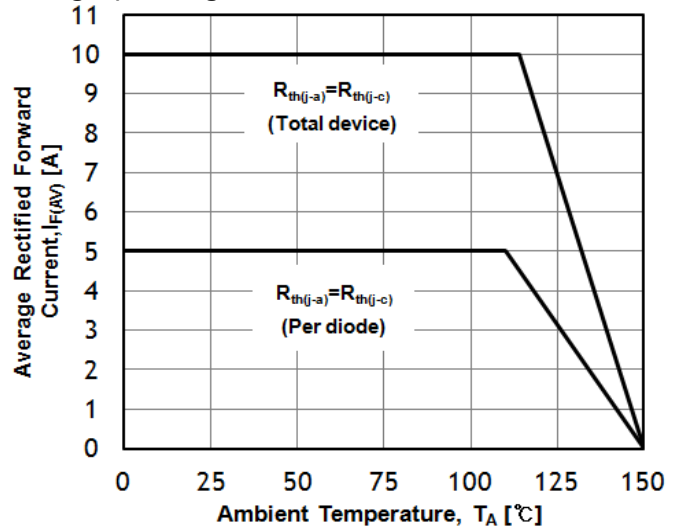
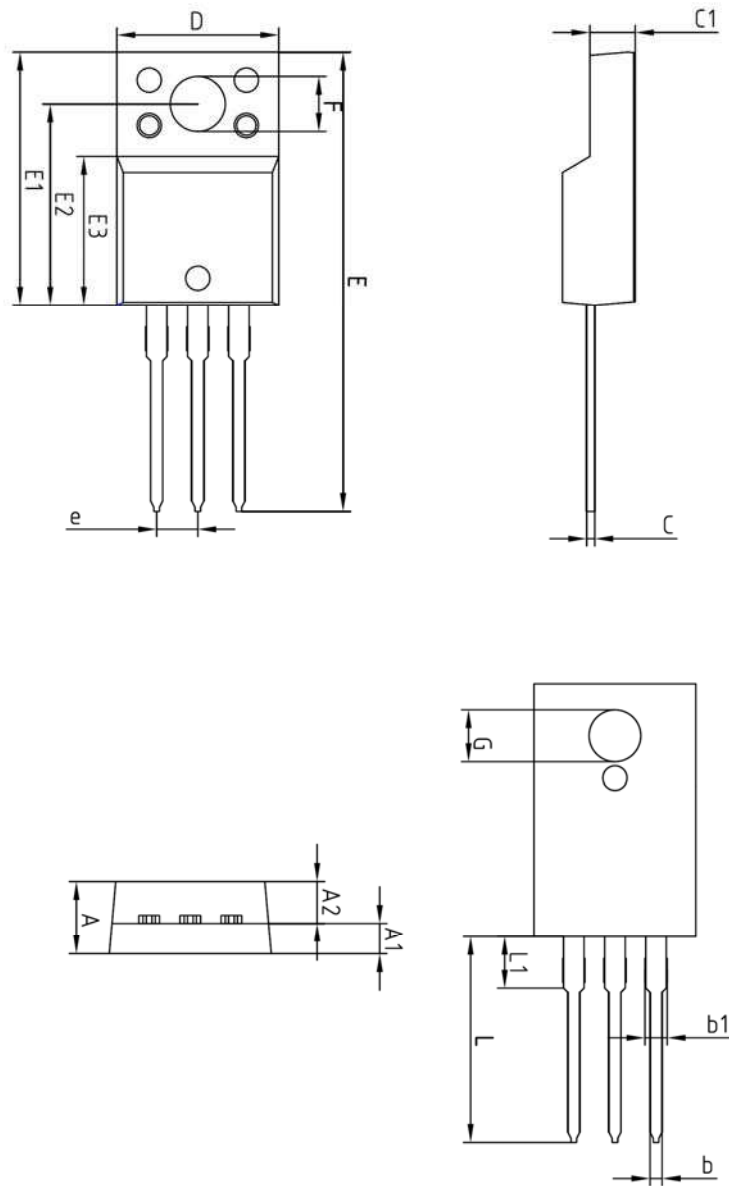

Fig. 6) Average Forward Current Characteristics



Package Outline Dimensions (Unit: mm)



SYMBOL	MILLIMETERS			NOTE
	MINIMUM	NOMINAL	MAXIMUM	
A	—	—	4.60	
A1	2.45	2.50	2.55	
A2	1.95	2.00	2.05	
b	0.65	0.75	0.85	
b1	1.07	1.27	1.47	
C	0.40	0.50	0.60	
C1	2.70	2.80	2.90	
D	9.90	10.00	10.10	
E	28.00	—	28.60	
E1	15.50	15.60	15.70	
E2	12.30	12.40	12.50	
E3	9.15	9.20	9.25	
F	3.30	3.40	3.50	
G	3.10	3.20	3.30	
e	2.34	2.54	2.74	
L	12.40	—	13.00	
L1	3.00	3.20	3.40	

The AUK Corp. products are intended for the use as components in general electronic equipment (Office and communication equipment, measuring equipment, home appliance, etc.).

Please make sure that you consult with us before you use these AUK Corp. products in equipments which require high quality and / or reliability, and in equipments which could have major impact to the welfare of human life(atomic energy control, airplane, spaceship, transportation, combustion control, all types of safety device, etc.). AUK Corp. cannot accept liability to any damage which may occur in case these AUK Corp. products were used in the mentioned equipments without prior consultation with AUK Corp..

Specifications mentioned in this publication are subject to change without notice.