

SG - 107

The SG - 107 reflective sensor combines a GaAs IRED with a high - sensitivity phototransistor in a super - mini package, reducing installation space.

FEATURES

- Compact
- High performance
- High - speed response
- Easy to mount on P.C.B.
- Widely applicable

APPLICATIONS

- Timing sensors
- Edge sensors
- Micro floppy disk drives
- Level sensors of liquid

DIMENSIONS

(Unit : mm)

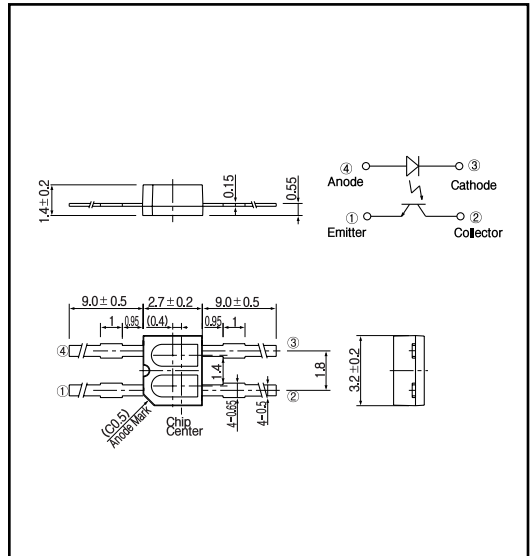

MAXIMUM RATINGS

(Ta=25)

	Item	Symbol	Rating	Unit
Input	Power dissipation	P _D	75	mW
	Reverse voltage	V _R	5	V
	Forward current	I _F	50	mA
	Pulse forward current ^{*1}	I _{FP}	1	A
Output	Collector power dissipation	P _C	50	mW
	Collector current	I _C	20	mA
	C - E voltage	V _{CE0}	30	V
	E - C voltage	V _{EC0}	3	V
	Operating temp.	Topr.	- 25 + 85	
	Storage temp.	Tstg.	- 30 + 100	
	Soldering temp. ^{*2}	Tsol.	240	

*1. t w 100 μsec, period : T=10msec.

*2. For MAX. 5 seconds at the position of 2mm from the package

ELECTRO-OPTICAL CHARACTERISTICS

(Ta=25)

	Item	Symbol	Conditions	Min.	Typ.	Max.	Unit.
Input	Forward voltage	V _F	I _F = 10mA			1.3	V
	Reverse current	I _R	V _R = 5V			10	μA
	Peak wavelength	λ			940		nm
Output	Collector dark current	I _{CEO}	V _{CE} = 10V			0.2	μA
	Ligh current	I _L	V _{CE} = 5V, I _F = 4mA	35	5		μA
	Leakage current	I _{CEO0}	V _{CE} = 5V, I _F = 10mA			0.2	μA
Switching speeds	Rise time	t _r	V _{CC} = 2V, I _L = 100μA, R _L = 1k		30		μsec.
	Fall time	t _f			25		μsec.

Photointerrupters(Reflective)

SG - 107

Collector power dissipation Vs. Ambient temperature

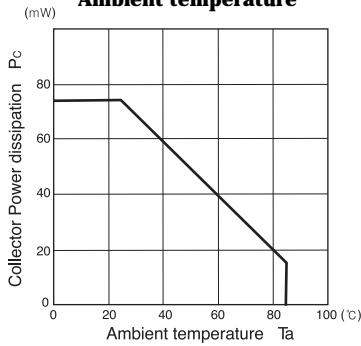

Forward current Vs. Forward voltage

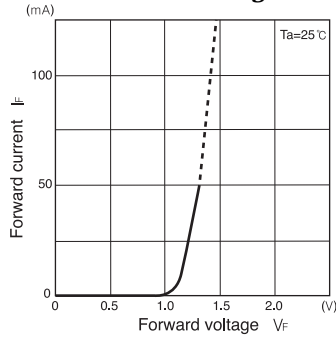

Light current Vs. Forward current

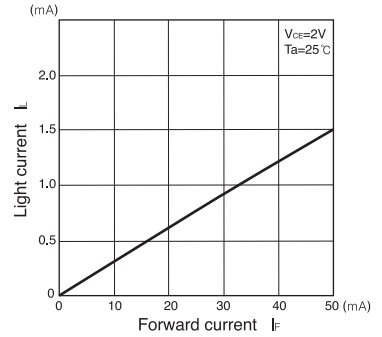

Light current Vs. Collector-Emitter voltage

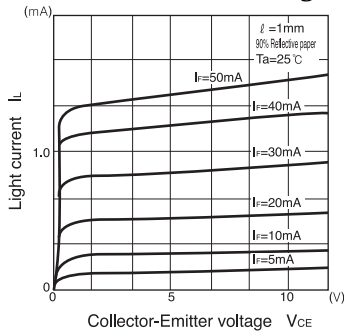

Relative light current Vs. Ambient temperature

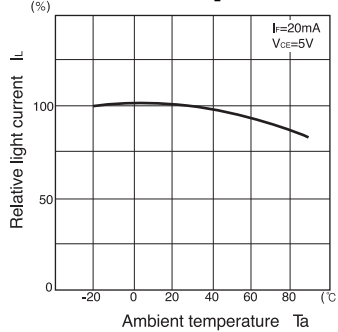

Dark current Vs. Ambient temperature

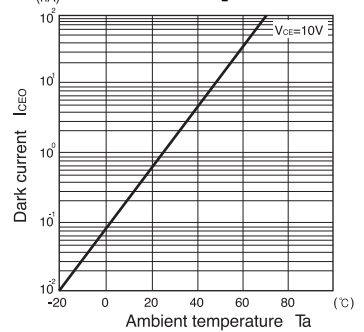

Switching time Vs. Load resistance

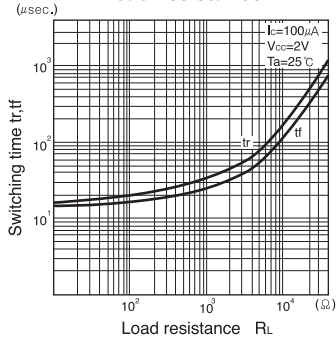

Relative light current Vs. Moving distance

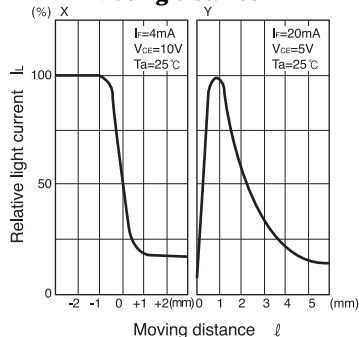

Switching time measurement circuit

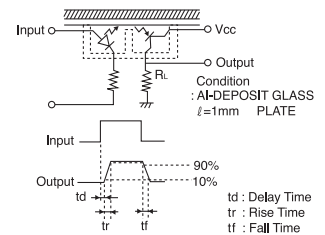

Method of measuring position characteristic

