



Product Description

RFMD's SGC-6489Z is a high performance SiGe HBT MMIC amplifier utilizing a Darlington configuration with an active bias network. The active bias network provides stable current over temperature and process Beta variations. Designed to run directly from a 5V supply, the SGC-6489Z does not require a dropping resistor as compared to traditional Darlington amplifiers. The SGC-6489Z product is designed for high linearity 5V gain block applications that require small size and minimal external components. It is internally matched to 50Ω.

Optimum Technology Matching® Applied

- GaAs HBT
- GaAs MESFET
- InGaP HBT
- SiGe BiCMOS
- Si BiCMOS
- SiGe HBT
- GaAs pHEMT
- Si CMOS
- Si BJT
- GaN HEMT
- InP HBT
- RF MEMS
- LDMOS

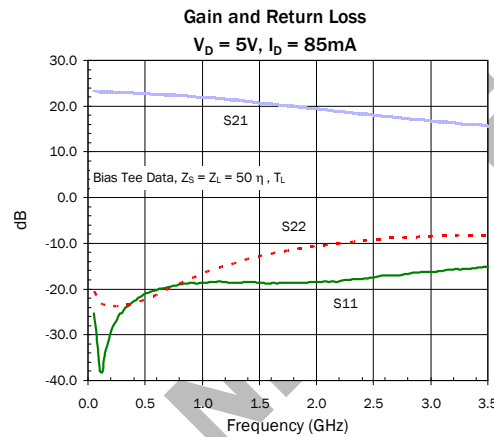

Features

- Single Supply Operation: 5V at $I_D = 85\text{mA}$
- No Dropping Resistor Required
- Patented Self Bias Circuitry
- Gain = 19.5dBm at 1950MHz
- P1dB = 19.2dBm at 1950MHz
- IP3 = 32.8dBm at 1950MHz
- Robust 1000V ESD, Class 1C HBM

Applications

- PA Driver Amplifier
- Cellular, PCS, GSM, UMTS
- IF Amplifier
- Wireless Data, Satellite

Parameter	Specification			Unit	Condition
	Min.	Typ.	Max.		
Small Signal Gain	20.7	22.2	23.7	dB	850MHz
	18.0	19.5	21.0	dB	1950MHz
		18.3		dB	2400MHz
Output Power at 1dB Compression		20.6		dBm	850MHz
	17.7	19.2		dBm	1950MHz
		18.4		dBm	2400MHz
Output Third Order Intercept Point		34.1		dBm	850MHz
	30.8	32.8		dBm	1950MHz
		31.4		dBm	2400MHz
Input Return Loss	14	18		dB	1950MHz
Output Return Loss	8	11		dB	1950MHz
Noise Figure		2.4	3.4	dB	1930MHz
Device Operating Voltage		5		V	
Device Operating Current	70	82	94	mA	
Thermal Resistance		70		°C/W	junction to lead

Test Conditions: $V_D = 5.0\text{V}$, $I_D = 82\text{mA}$, $T_L = 25^\circ\text{C}$, OIP3 Tone Spacing = 1MHz, Bias Tee Data, $Z_S = Z_L = 50\Omega$, P_{OUT} per tone = 0dBm

Absolute Maximum Ratings

Parameter	Rating	Unit
Max Device Current (I_{CE})	100	mA
Max Device Voltage (V_{CE})	7	V
Max RF Input Power* (See Note)	3	dBm
Max Junction Temperature (T_J)	+150	°C
Operating Temperature Range (T_L)	-40 to +85	°C
Max Storage Temperature	+150	°C
ESD Rating - Human Body Model (HBM)	Class 1C	
Moisture Sensitivity Level	MSL 2	

*Note: Load condition $Z_L = 50\Omega$

Operation of this device beyond any one of these limits may cause permanent damage. For reliable continuous operation, the device voltage and current must not exceed the maximum operating values specified in the table on page one.

Bias Conditions should also satisfy the following expression:

$$I_D V_D < (T_J - T_L) / R_{TH, J - I} \text{ and } T_L = T_{LEAD}$$



Caution! ESD sensitive device.

Exceeding any one or a combination of the Absolute Maximum Rating conditions may cause permanent damage to the device. Extended application of Absolute Maximum Rating conditions to the device may reduce device reliability. Specified typical performance or functional operation of the device under Absolute Maximum Rating conditions is not implied.

The information in this publication is believed to be accurate and reliable. However, no responsibility is assumed by RF Micro Devices, Inc. ("RFMD") for its use, nor for any infringement of patents, or other rights of third parties, resulting from its use. No license is granted by implication or otherwise under any patent or patent rights of RFMD. RFMD reserves the right to change component circuitry, recommended application circuitry and specifications at any time without prior notice.



RFMD Green: RoHS compliant per EU Directive 2002/95/EC, halogen free per IEC 61249-2-21, < 1000ppm each of antimony trioxide in polymeric materials and red phosphorus as a flame retardant, and <2% antimony in solder.

Typical RF Performance at Key Operating Frequencies (Bias Tee Data)

Parameter	Unit	100	500	850	1950	2140	2400	3500
		MHz	MHz	MHz	MHz	MHz	MHz	MHz
Small Signal Gain (G)	dB	23.1	22.7	22.2	19.5	19.0	18.3	15.7
Output Third Order Intercept Point (OIP_3)	dBm	35.1	34.3	34.1	32.8	32.7	31.4	27.4
Output Power at 1dB Compression (P_{1dB})	dBm	21.8	20.9	20.6	19.2	19.0	18.4	15.2
input Return Loss (IRL)	dB	37.0	22.0	19.0	18.0	18.0	17.0	16.0
Output Return Loss (ORL)	dB	23.0	22.0	19.0	11.0	11.0	10.0	8.0
Reverse Isolation (S_{12})	dB	25.0	25.0	26.0	25.0	25.0	24.0	22.0
Noise Figure (NF)	dB	1.8	2.0	2.1	2.4	2.4	2.5	2.9

Test Conditions: $V_D = 5V$ $I_D = 85mA$ OIP_3 Tone Spacing = 1MHz, P_{OUT} per tone = 0dBm $T_L = 25^\circ C$ $Z_S = Z_L = 50\Omega$

Typical Performance with Bias Tees, $V_D = 5V$, $I_D = 82mA$

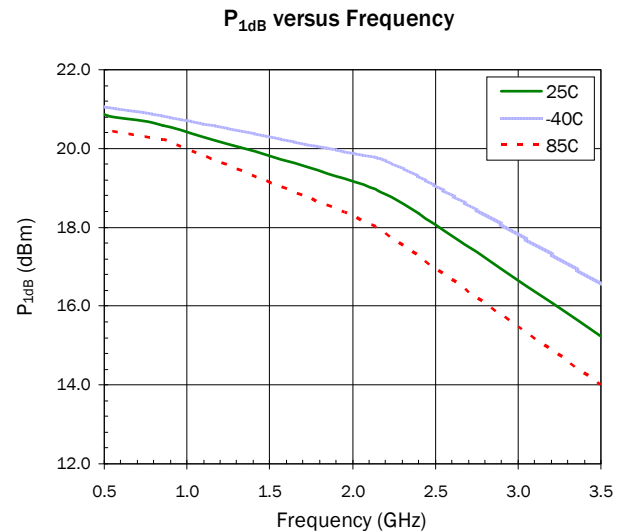
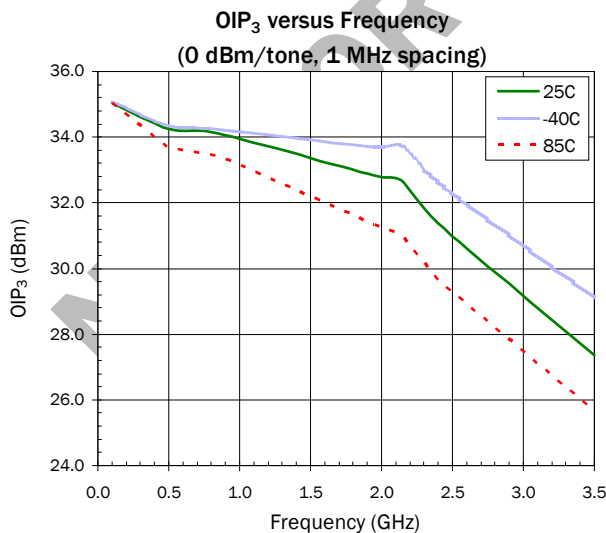

Typical Performance with Bias Tees, $V_D = 5V$, $I_D = 82mA$

S11 versus Frequency

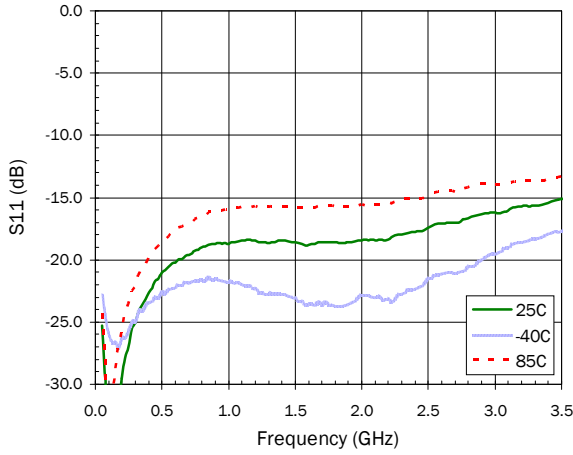

S21 versus Frequency

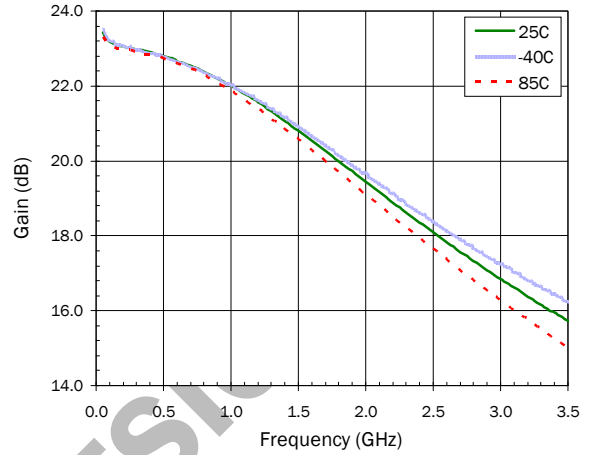

S12 versus Frequency

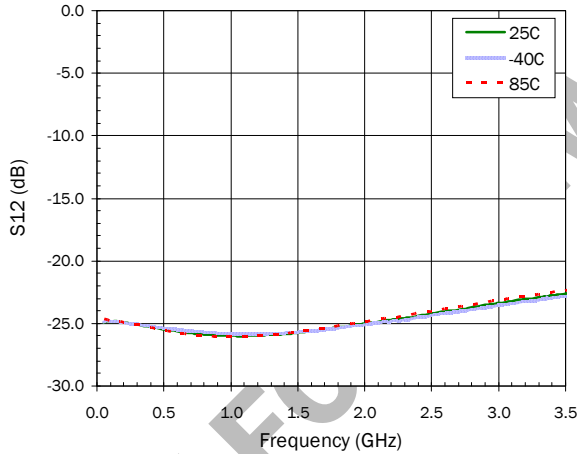

S22 versus Frequency

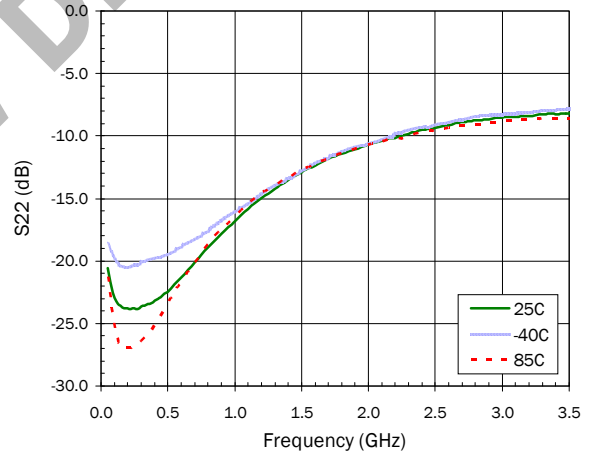

NF versus Frequency

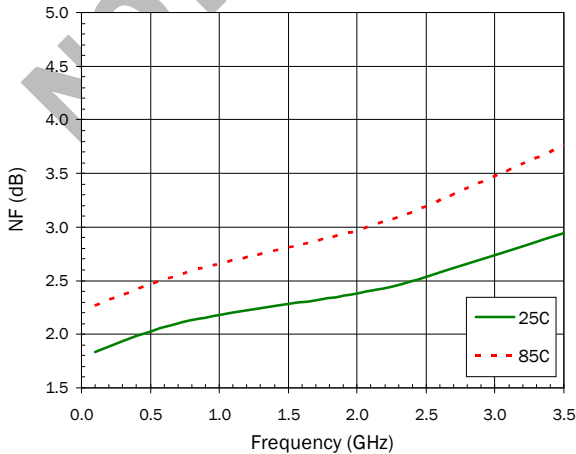

DCIV versus Temperature

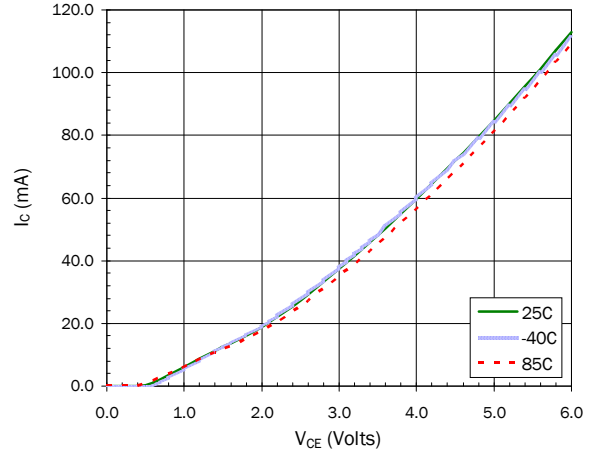

Pin	Function	Description
1	RF IN	RF input pin. This pin requires the use of an external DC blocking capacitor chosen for the frequency of operation.
2, 4	GND	Connection to ground. Use via holes as close to the device ground leads as possible to reduce ground inductance and achieve optimum RF performance.
3	RF OUT/ DCBIAS	RF output and bias pin. This pin requires the use of an external DC blocking capacitor chosen for the frequency of operation.

Suggested PCB Pad Layout

Dimensions in inches (millimeters)

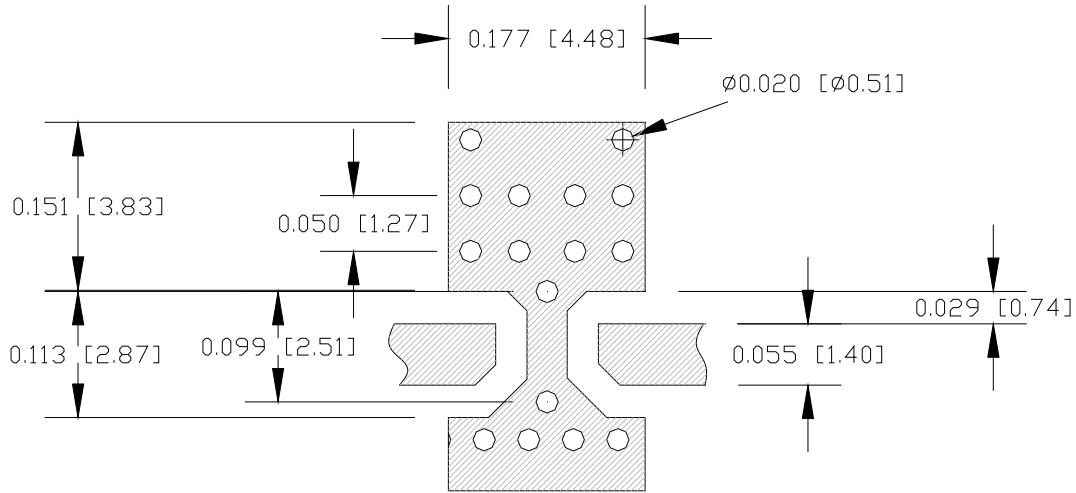

Package Drawing

Dimensions in inches (millimeters)

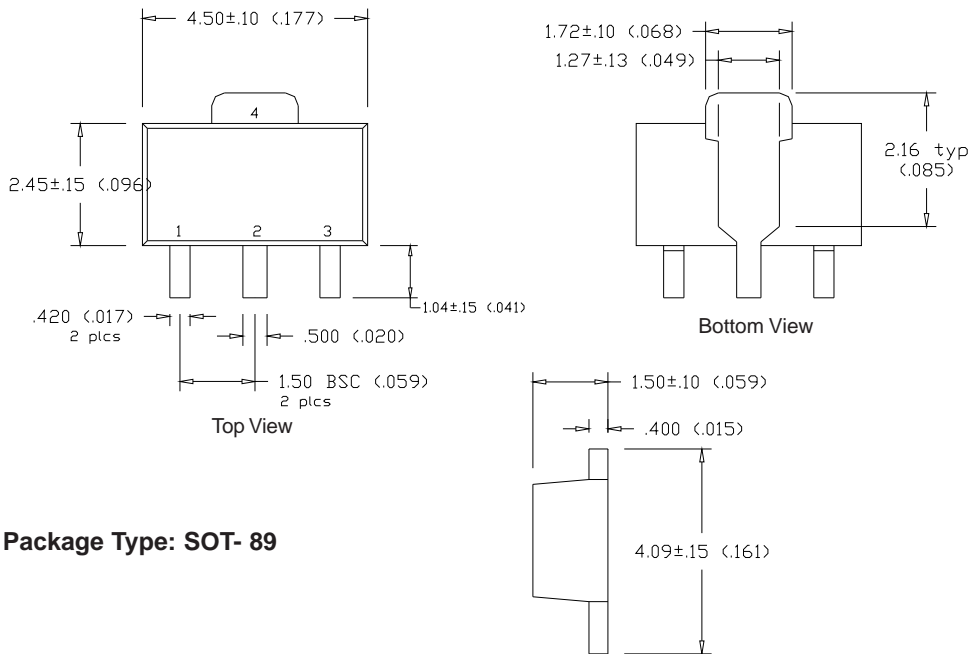

Package Type: SOT- 89

Application Schematic

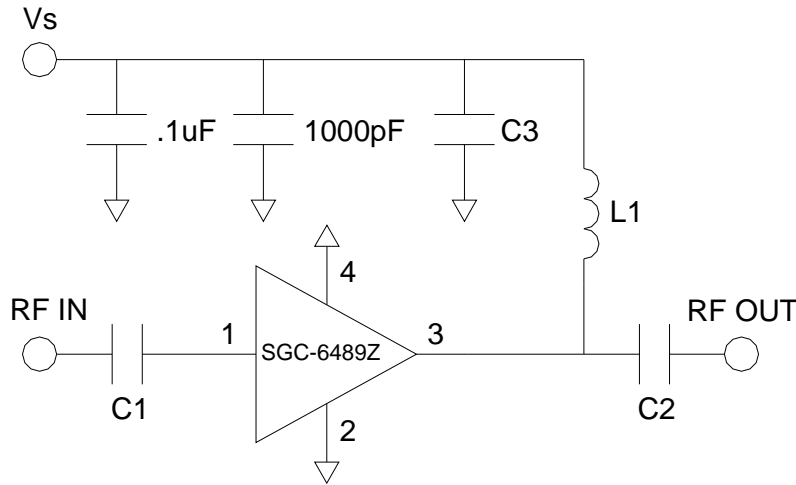

Reference Designator	500 - 2100 MHz
C1	43pF
C2	43pF
C3	100pF
L1	48nH 0805HQ CC

Evaluation Board

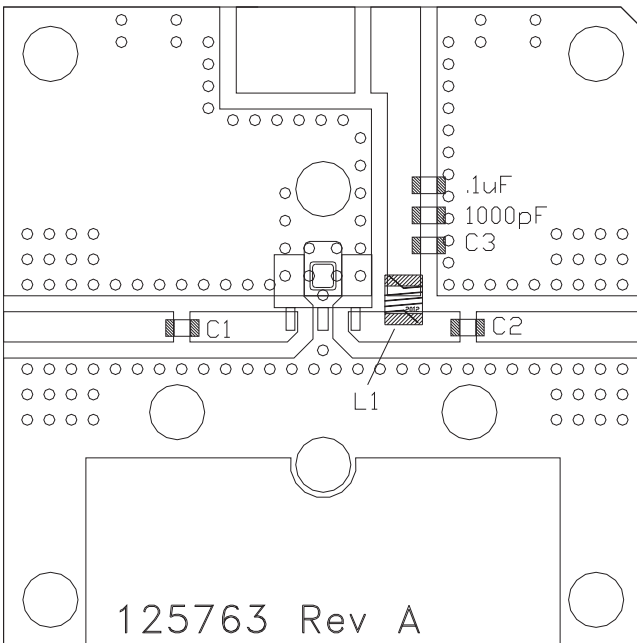

Mounting Instructions

1. Solder the copper pad on the backside of the device package to the ground plane.
2. Use a large ground pad area with many plated through-holes as shown.
3. We recommend 1 or 2 ounce copper. Measurements for this data sheet were made on a 31 mil thick FR-4 board with 1 ounce copper on both sides.

Part Identification

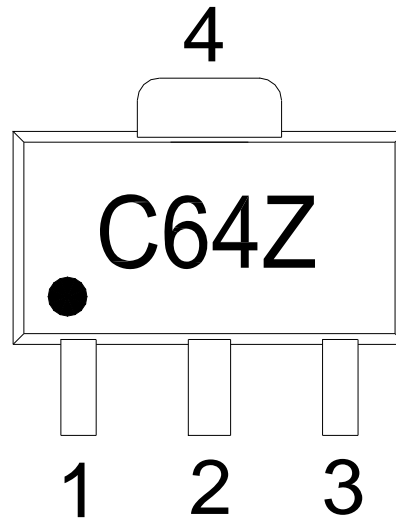

Alternate marking "SGC6489Z" on line one with Trace Code on line two.

Ordering Information

Part Number	Package / Lead Composition	Reel Size	Devices / Reel
SGC-6489Z	Lead Free, RoHS Compliant	13"	3000
SGC-6489Z-EVB1	100-1000 MHz Evaluation Board	N/A	N/A
SGC-6489Z-EVB2	500-2100 MHz Evaluation Board	N/A	N/A

NOT A