

## Features

- Low profile - typical height 1.1 mm
- Low forward voltage drop
- Low leakage current
- Moisture sensitivity: level 1, per J-STD-020
- High temperature soldering guaranteed: 260°C/10 seconds
- Halogen-free according to IEC 61249-2-21 definition

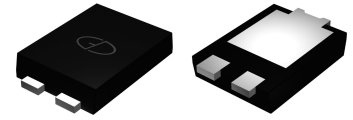

Package:  
eSGC (TO-277)

## Applications

For low voltage high frequency inverters, DC/DC converters and polarity protection applications.

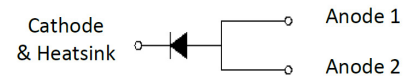

Schematic Diagram

## Maximum Ratings ( $T_A = 25^\circ\text{C}$ unless otherwise noted)

Parameter	Symbol	Value	Unit
Maximum Repetitive Peak Reverse Voltage	$V_{RRM}$	100	V
Maximum RMS Voltage	$V_{RMS}$	70	V
Maximum DC Blocking Voltage	$V_{DC}$	100	V
Maximum Average Forward Rectified Current	$I_{F(AV)}^{1)}$	5.0	A
	$I_{F(AV)}^{2)}$	10.0	
Peak Forward Surge Current (8.3ms single half sine-wave superimposed on rated load)	$I_{FSM}$	220	A
Operating Junction and Storage Temperature Range	$T_J, T_{STG}$	-55 to +150	$^\circ\text{C}$

## Electrical Characteristics ( $T_A = 25^\circ\text{C}$ unless otherwise noted)

Parameter	Test Conditions	Symbol	Typ.	Max.	Unit	
Maximum Instantaneous Forward Voltage	$I_F=1\text{A}$	$V_F$	0.38	-	V	
	$I_F=2\text{A}$		0.41	-		
	$I_F=10\text{A}$		0.54	0.65		
	$I_F=10\text{A}$		0.50	0.60		
Maximum DC Reverse Current at Rated DC Blocking Voltage	$V_R=80\text{V}$	$I_R$	$T_A=25^\circ\text{C}$	14.9	-	$\mu\text{A}$
			$T_A=125^\circ\text{C}$	9.6	-	mA
	$V_R=100\text{V}$	$I_R$	$T_A=25^\circ\text{C}$	29.5	250	$\mu\text{A}$
			$T_A=125^\circ\text{C}$	15.2	50	mA
Typ. Junction Capacitance	4.0 V, 1 MHz	$C_J$	290		pF	
Typ. Thermal Resistance	Junction to Ambient	$R_{\theta JA}^{1)}$	75		$^\circ\text{C}/\text{W}$	
	Junction to Mount	$R_{\theta JM}^{2)}$	1		$^\circ\text{C}/\text{W}$	

Notes 1)Thermal resistance  $R_{\theta JA}$  is junction to ambient. Free air, mounted on P.C.B with recommended copper pad area, 2 OZ, FR4

2)Thermal resistance  $R_{\theta JM}$  is junction to mount. Mounted on P.C.B with 30\*30mm copper pad area

## Ratings and Characteristics Curves ( $T_A = 25^\circ\text{C}$ unless otherwise noted)

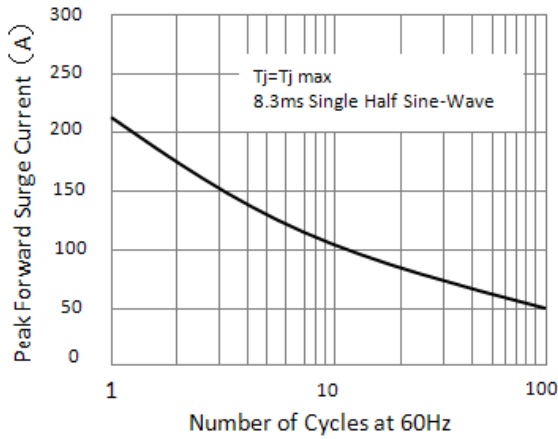

Figure 1. Maximum Non-Repetitive Peak Forward Surge Current

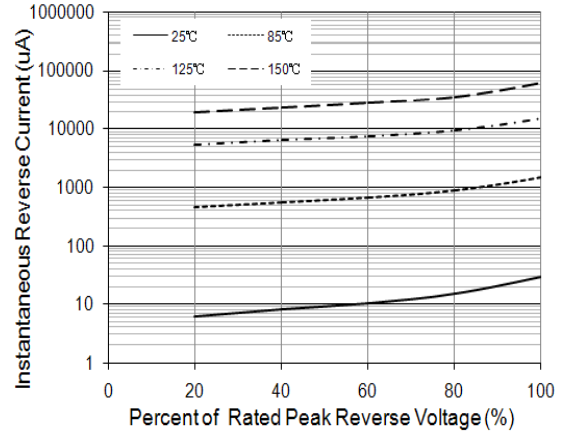

Figure 2. Typical Reverse Characteristics

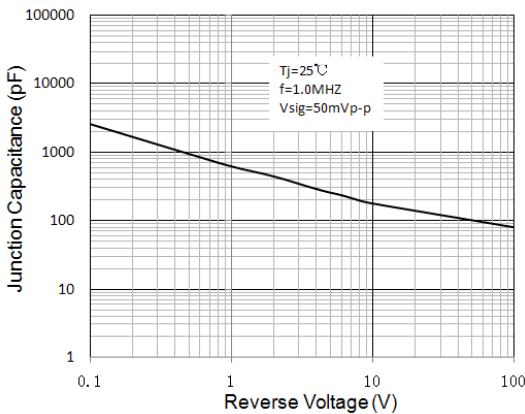

Figure 3. Typical Junction Capacitance

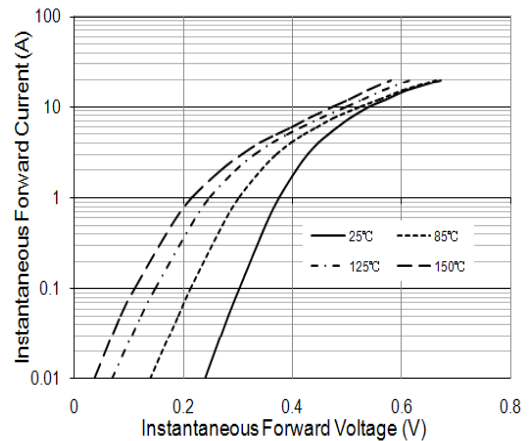

Figure 4. Typical Instantaneous Forward Characteristics

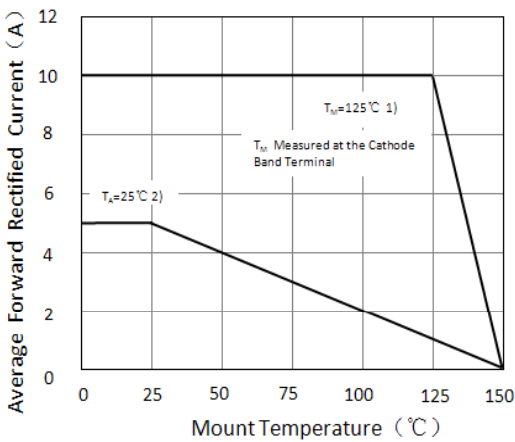

Figure 5. Forward Current Derating Curve

### Notes

- 1) Mounted on P.C.B with 30\*30mm copper pad area
- 2) Fre air, Mounted on recommended copper pad area FR4 PCB ( $R_{\theta JA} = 76^\circ\text{C}/\text{W}$ )

## Package Outline Dimensions

eSGC (TO-277)

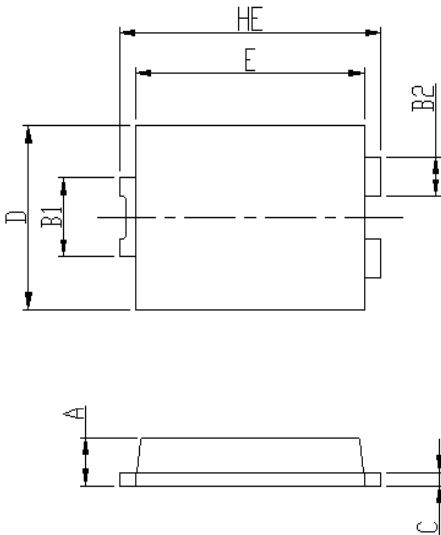

DIM	Unit: mm		Unit: inch	
	MIN	MAX	MIN	MAX
HE	6.4	6.6	0.252	0.260
E	5.6	5.8	0.220	0.228
D	4.1	4.3	0.161	0.169
B1	1.7	1.9	0.067	0.075
B2	0.8	1	0.031	0.039
A	1.05	1.2	0.041	0.047
C	0.3	0.4	0.012	0.016
L	0.85	1.1	0.033	0.043
L1	4.2	4.4	0.165	0.173
L2	3.52 Typ.		0.139 Typ.	
L3	1.1	1.4	0.043	0.055
D1	3	3.3	0.118	0.130
E1	1.86 Typ.		0.073 Typ.	

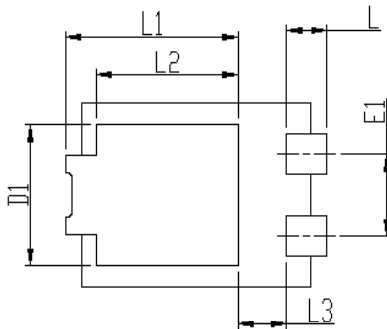

Soldering footprint

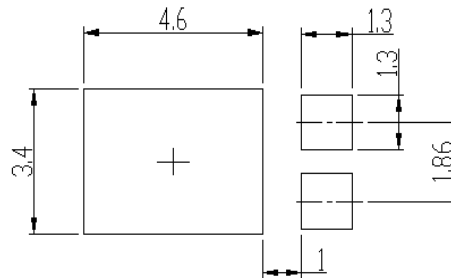

## Packing Information

### Packing quantities

5000 pcs/Reel, 12 mm Tape, 13" Reel

### Tape & Reel Specification

