

GENERAL DESCRIPTION

The SGM2036-0.75 is a low noise, low voltage and low dropout voltage linear regulator. It is capable of supplying 300mA output current with typical dropout voltage of only 950mV. The operating input voltage range is from 1.6V to 5.5V. The fixed output voltage is 0.75V.

Other features include logic-controlled shutdown mode, short-circuit current limit and thermal shutdown protection. The SGM2036-0.75 has automatic discharge function to quickly discharge V_{OUT} in the disabled status.

The SGM2036-0.75 is available in Green SOT-23-5 and UTDFN-1×1-4L packages. It operates over an operating temperature range of -40°C to +85°C.

FEATURES

- **Operating Input Voltage Range: 1.6V to 5.5V**
- **Fixed Output Voltage: 0.75V**
- **300mA Guaranteed Output Current**
- **High Output Voltage Accuracy**
- **Low Dropout Voltage: 950mV (TYP) at 300mA**
- **Low Output Noise**
- **Low Supply Current: 20μA (TYP)**
- **Shutdown Supply Current: 0.01μA (TYP)**
- **Short Start-Up Time**
- **Short Auto-Discharge Function**
- **Thermal Shutdown Protection**
- **Short-Circuit Current Limit**
- **Fast Load and Line Transient Responses**
- **-40°C to +85°C Operating Temperature Range**
- **Available in Green SOT-23-5 and UTDFN-1×1-4L Packages**

APPLICATIONS

- Modems
- Cellular Telephones
- PCMCIA Cards
- Palmtop Computers
- Portable Electronics

TYPICAL APPLICATION

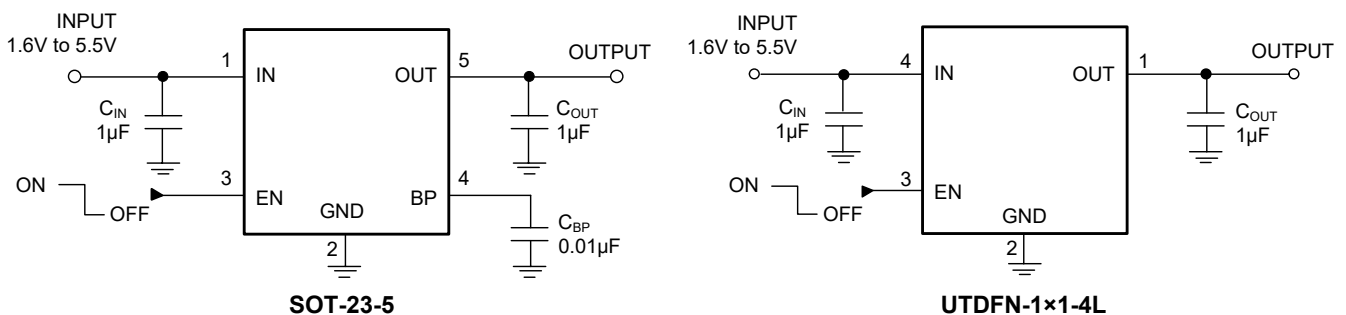

Figure 1. Typical Application Circuits

PACKAGE/ORDERING INFORMATION

MODEL	PACKAGE DESCRIPTION	SPECIFIED TEMPERATURE RANGE	ORDERING NUMBER	PACKAGE MARKING	PACKING OPTION
SGM2036-0.75	SOT-23-5	-40°C to +85°C	SGM2036-0.75YN5G/TR	MCEXX	Tape and Reel, 3000
SGM2036-0.75	UTDFN-1×1-4L	-40°C to +85°C	SGM2036-0.75YUDH4G/TR	G9	Tape and Reel, 10000

MARKING INFORMATION

NOTE: XX = Date Code.

SOT-23-5

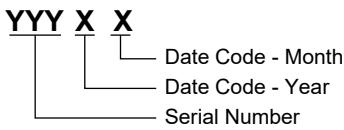

UTDFN-1×1-4L

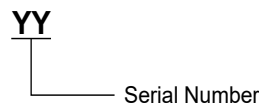

Green (RoHS & HSF): SG Micro Corp defines "Green" to mean Pb-Free (RoHS compatible) and free of halogen substances. If you have additional comments or questions, please contact your SGMICRO representative directly.

ABSOLUTE MAXIMUM RATINGS

IN to GND	-0.3V to 6V
Output Short-Circuit Duration.....	Infinite
EN to GND.....	-0.3V to 6V
OUT, BP to GND.....	-0.3V to (V _{IN} + 0.3V)
Power Dissipation, P _D @ T _A = +25°C	
SOT-23-5.....	390mW
UTDFN-1×1-4L	400mW
Package Thermal Resistance	
SOT-23-5, θ _{JA}	285°C/W
UTDFN-1×1-4L, θ _{JA}	280°C/W
Junction Temperature	+150°C
Storage Temperature Range.....	-65°C to +150°C
Lead Temperature (Soldering, 10s).....	+260°C
ESD Susceptibility	
HBM.....	4000V
MM.....	400V
CDM	1000V

RECOMMENDED OPERATING CONDITIONS

Operating Voltage Range.....	1.6V to 5.5V
Enable Input Voltage Range	0V to 5.5V
Input Effective Capacitance, C _{IN}	0.1µF (MIN)
Output Effective Capacitance, C _{OUT}	0.5µF to 10µF
Operating Junction Temperature Range	-40°C to +85°C

OVERSTRESS CAUTION

Stresses beyond those listed in Absolute Maximum Ratings may cause permanent damage to the device. Exposure to absolute maximum rating conditions for extended periods may affect reliability. Functional operation of the device at any conditions beyond those indicated in the Recommended Operating Conditions section is not implied.

ESD SENSITIVITY CAUTION

This integrated circuit can be damaged if ESD protections are not considered carefully. SGMICRO recommends that all integrated circuits be handled with appropriate precautions. Failure to observe proper handling and installation procedures can cause damage. ESD damage can range from subtle performance degradation to complete device failure. Precision integrated circuits may be more susceptible to damage because even small parametric changes could cause the device not to meet the published specifications.

DISCLAIMER

SG Micro Corp reserves the right to make any change in circuit design, or specifications without prior notice.

PIN CONFIGURATIONS

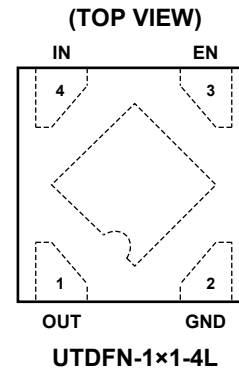
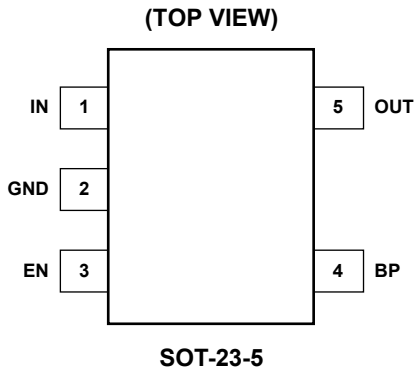

PIN DESCRIPTION

PIN		NAME	FUNCTION
SOT-23-5	UTDFN-1x1-4L		
1	4	IN	Input Voltage Supply Pin. It is recommended to use a 1μF or larger ceramic capacitor from IN pin to ground. This ceramic capacitor should be placed as close as possible to IN pin.
2	2	GND	Ground.
3	3	EN	Enable Pin. Drive EN high to turn on the regulator. Drive EN low to turn off the regulator. This pin must be pulled high by an external resistor connected to IN pin if EN pin is not used.
4	–	BP	Reference-Noise Bypass Pin. Bypass with an external capacitor C _{BP} can reduce output noise to very low level. The capacitor is recommended to be placed very close to the pin for high PSRR.
5	1	OUT	Regulator Output Pin. It is recommended to use a ceramic capacitor with effective capacitance in the range of 0.5μF to 10μF to get good power supply decoupling. This ceramic capacitor should be placed as close as possible to OUT pin.
–	Exposed Pad	–	Exposed Pad. Connect it to GND internally. Connect it to a large ground plane to maximize thermal performance; this pad is not an electrical connection point.

ELECTRICAL CHARACTERISTICS

(V_{IN} = 2.5V, Full = -40°C to +85°C, unless otherwise noted.)

PARAMETER	SYMBOL	CONDITIONS	TEMP	MIN	TYP	MAX	UNITS	
Input Voltage	V _{IN}		+25°C	1.6		5.5	V	
Output Voltage Accuracy		I _{OUT} = 0.1mA	+25°C	-2.5		+2.5	%	
Maximum Output Current			+25°C	300			mA	
Current Limit	I _{LIM}		+25°C	360	560		mA	
Supply Pin Current	I _Q	No load, V _{EN} = V _{IN}	+25°C		20	26	µA	
Dropout Voltage ⁽¹⁾	V _{DROP}	I _{OUT} = 300mA	+25°C		950	1300	mV	
Line Regulation	$\frac{\Delta V_{OUT}}{\Delta V_{IN} \times V_{OUT}}$	V _{IN} = 1.6V to 5.5V, I _{OUT} = 1mA	+25°C		0.01	0.1	%/V	
Load Regulation	ΔV _{OUT}	I _{OUT} = 0.1mA to 300mA	+25°C		12	40	mV	
Short Current Limit	I _{SHORT}	V _{OUT} = 0V	+25°C		200		mA	
Power Supply Rejection Ratio	PSRR	C _{BP} = 0µF, I _{OUT} = 30mA, C _{OUT} = 1µF, V _{IN} = 1.75V, ΔV _{RIPPLE} = 0.2V _{P-P}	f = 217Hz	+25°C		74	dB	
			f = 1kHz	+25°C		61		
			C _{BP} = 0.01µF, I _{OUT} = 30mA, C _{OUT} = 1µF, V _{IN} = 1.75V, ΔV _{RIPPLE} = 0.2V _{P-P}	f = 217Hz	+25°C			82
				f = 1kHz	+25°C			70
Output Voltage Noise	e _n	C _{BP} = 0µF, C _{OUT} = 1µF, f = 10Hz to 100kHz	I _{OUT} = 0mA	+25°C		40	µV _{RMS}	
			I _{OUT} = 30mA	+25°C		76		
			C _{BP} = 0.01µF, C _{OUT} = 1µF, f = 10Hz to 100kHz	I _{OUT} = 0mA	+25°C			12
				I _{OUT} = 30mA	+25°C			40
Shutdown								
EN Input Threshold	V _{IH}	V _{IN} = 1.6V to 5.5V	Full	1.5			V	
	V _{IL}		Full			0.4		
EN Input Bias Current	I _{BH}	V _{EN} = 5.5V	Full		0.8	2	µA	
	I _{BL}	V _{EN} = 0V	Full		0.01	1		
Shutdown Supply Current	I _{SHDN}	V _{EN} = 0V	Full		0.01	1	µA	
Start-Up Time	t _{STR}	C _{OUT} = 1µF, no load, from assertion of V _{EN} to V _{OUT} = 90% × V _{OUT(NOM)}	+25°C		30		µs	
R _{ON} of Discharge MOSFET		V _{IN} = 4.0V, V _{EN} = 0V	+25°C		50		Ω	
Thermal Protection								
Thermal Shutdown Temperature	T _{SHDN}				140		°C	
Thermal Shutdown Hysteresis	ΔT _{SHDN}				15		°C	

NOTE:

1. The dropout voltage is defined as the difference between V_{IN} and V_{OUT} when V_{OUT} falls to V_{OUT(NOM)} - 60mV for V_{IN} = 2.5V.

FUNCTIONAL BLOCK DIAGRAM

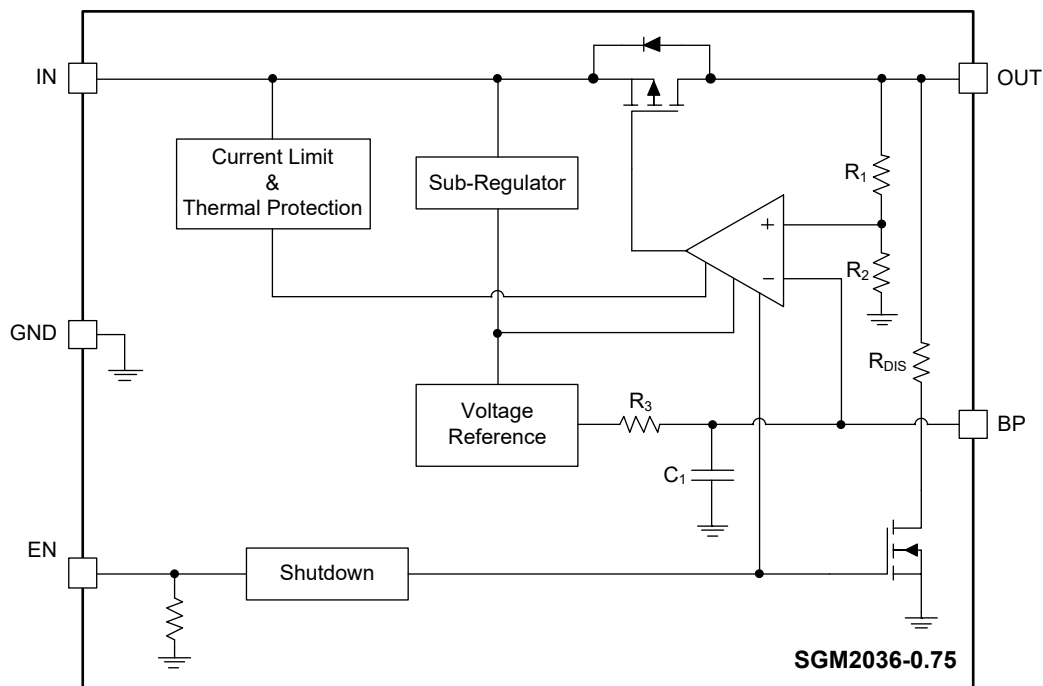

Figure 2. Block Diagram

APPLICATION INFORMATION

The SGM2036-0.75 is a low input voltage, ultra-low noise and low dropout LDO and provides 300mA output current. These features make the device a reliable solution to solve many challenging problems in the generation of clean and accurate power supply. The high performance also makes the SGM2036-0.75 useful in a variety of applications. The SGM2036-0.75 provides the protection function for output overload, output short-circuit condition and overheating.

The SGM2036-0.75 provides an EN pin as an external chip enable control to enable/disable the device. When the regulator is in shutdown state, the shutdown current consumes as low as 0.04 μ A (TYP).

Input Capacitor Selection (C_{IN})

The input decoupling capacitor is necessary to be connected as close as possible to the IN pin for ensuring the device stability. 1 μ F or greater X7R or X5R ceramic capacitor is selected to get good dynamic performance.

When V_{IN} is required to provide large current instantaneously, a large effective input capacitor is required. Multiple input capacitors can limit the input tracking inductance. Adding more input capacitors is available to restrict the ringing and to keep it below the device absolute maximum ratings.

Output Capacitor Selection (C_{OUT})

The output decoupling capacitor should be located as close as possible to the OUT pin. 1 μ F or greater X7R or X5R ceramic capacitor is selected to get good dynamic performance. The minimum effective capacitance of C_{OUT} that SGM2036-0.75 can remain stable is 0.5 μ F. For ceramic capacitor, temperature, DC bias and package size will change the effective capacitance, so enough margin of C_{OUT} must be considered in design. Larger capacitance and lower ESR C_{OUT} will help improve the load transient response and increase the high frequency PSRR.

Enable Control

The SGM2036-0.75 uses the EN pin to enable/disable its device and to deactivate/activate the output

automatic discharge function.

When the EN pin voltage is lower than 0.4V, the device is in shutdown state, there is no current flowing from IN to OUT pins. In this state, the automatic discharge transistor is active to discharge the output voltage through a 50 Ω (TYP) resistor.

When the EN pin voltage is higher than 1.5V, the device is in active state, the input voltage is regulated to the output voltage and the automatic discharge transistor is turned off.

The EN pin is pulled down by internal 0.8 μ A (TYP) current source when the EN pin is floated. This current source will ensure the SGM2036-0.75 in shutdown state and reduce the power dissipation in system.

Output Current Limit and Short-Circuit Protection

When overload events happen, the output current is internally limited to 560mA (TYP). When the OUT pin is shorted to ground, the short-circuit protection will limit the output current to 200mA (TYP).

Thermal Shutdown

The SGM2036-0.75 can detect the temperature of die. When the die temperature exceeds the threshold value of thermal shutdown, the SGM2036-0.75 will be in shutdown state and it will remain in this state until the die temperature decreases to +125°C.

Negatively Biased Output

When the output is negative voltage, the chip may not start up due to parasitic effects. Ensure that the output is greater than -0.3V under all conditions. If excessive negatively biased output is expected in the application, a Schottky diode can be added between the OUT pin and GND pin.

Reverse Current

The pass transistor has an inherent body diode which will be forward biased in the case when $V_{OUT} > (V_{IN} + 0.3V)$. If extended reverse voltage operation is anticipated, external limiting might be appropriate.

REVISION HISTORY

NOTE: Page numbers for previous revisions may differ from page numbers in the current version.

NOVEMBER 2021 – REV.A.2 to REV.A.3	Page
Updated Recommended Operating Conditions section	2
<hr/>	
FEBRUARY 2021 – REV.A.1 to REV.A.2	Page
Updated ABSOLUTE MAXIMUM RATINGS	2
<hr/>	
JUNE 2019 – REV.A to REV.A.1	Page
Added UTDFN-1×1-4L package	All
Updated ABSOLUTE MAXIMUM RATINGS	2
<hr/>	
Changes from Original (APRIL 2018) to REV.A	Page
Changed from product preview to production data	All

PACKAGE INFORMATION

PACKAGE OUTLINE DIMENSIONS

SOT-23-5

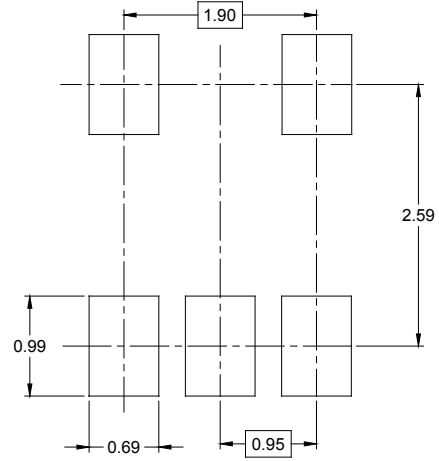
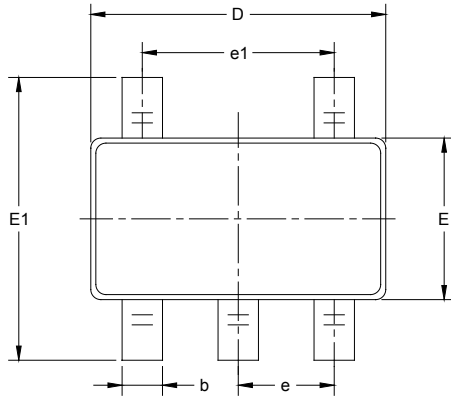

RECOMMENDED LAND PATTERN (Unit: mm)

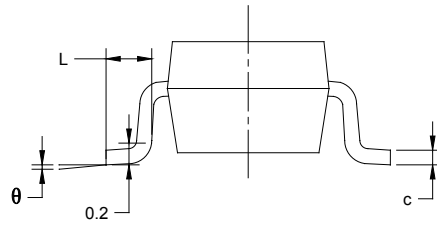
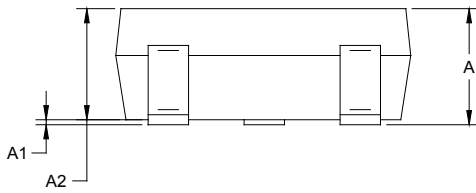

Symbol	Dimensions In Millimeters		Dimensions In Inches	
	MIN	MAX	MIN	MAX
A	1.050	1.250	0.041	0.049
A1	0.000	0.100	0.000	0.004
A2	1.050	1.150	0.041	0.045
b	0.300	0.500	0.012	0.020
c	0.100	0.200	0.004	0.008
D	2.820	3.020	0.111	0.119
E	1.500	1.700	0.059	0.067
E1	2.650	2.950	0.104	0.116
e	0.950 BSC		0.037 BSC	
e1	1.900 BSC		0.075 BSC	
L	0.300	0.600	0.012	0.024
θ	0°	8°	0°	8°

PACKAGE OUTLINE DIMENSIONS

UTDFN-1×1-4L

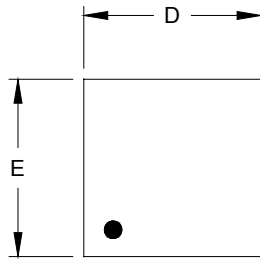

TOP VIEW

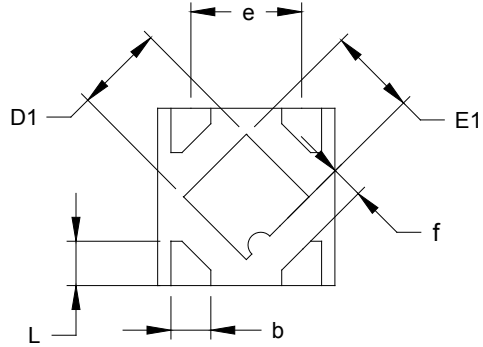

BOTTOM VIEW

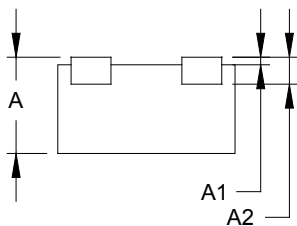

SIDE VIEW

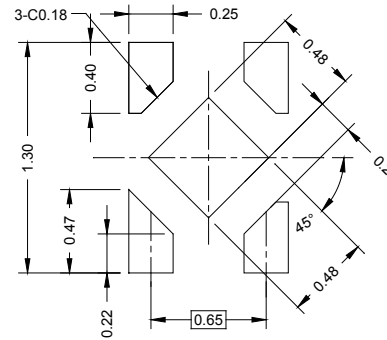

RECOMMENDED LAND PATTERN (Unit: mm)

Symbol	Dimensions In Millimeters		
	MIN	MOD	MAX
A	0.500	0.550	0.600
A1	0.000		0.050
A2	0.152 REF		
D	0.950	1.000	1.050
D1	0.450	0.500	0.550
E	0.950	1.000	1.050
E1	0.450	0.500	0.550
b	0.175	0.225	0.275
e	0.625 BSC		
f	0.195 REF		
L	0.200	0.250	0.300

TAPE AND REEL INFORMATION

REEL DIMENSIONS



TAPE DIMENSIONS



NOTE: The picture is only for reference. Please make the object as the standard.

KEY PARAMETER LIST OF TAPE AND REEL

Package Type	Reel Diameter	Reel Width W1 (mm)	A0 (mm)	B0 (mm)	K0 (mm)	P0 (mm)	P1 (mm)	P2 (mm)	W (mm)	Pin1 Quadrant
SOT-23-5	7"	9.5	3.20	3.20	1.40	4.0	4.0	2.0	8.0	Q3
UTDFN-1×1-4L	7"	9.0	1.18	1.18	0.68	4.0	2.0	2.0	8.0	Q1

000001

PACKAGE INFORMATION

CARTON BOX DIMENSIONS



NOTE: The picture is only for reference. Please make the object as the standard.

KEY PARAMETER LIST OF CARTON BOX

Reel Type	Length (mm)	Width (mm)	Height (mm)	Pizza/Carton
7" (Option)	368	227	224	8
7"	442	410	224	18

DD0002