

GENERAL DESCRIPTION

The SGM2526 is a compact electronic fuse (eFuse), which can operate from 4.5V to 22V single supply. A 23mΩ low $R_{DS(ON)}$ N-MOSFET is integrated. The two clamping output threshold voltages can be programmed through VCP pin. The clamping voltage protection function can ensure the safe operation of surge events in any state.

The soft-start time can be adjusted by setting an additional capacitor to the SST/nFAULT pin. Thermal shutdown shuts off the output MOSFET if the die temperature exceeds +150°C, and the output MOSFET remains off until the die temperature drops to +130°C.

The SGM2526 is available in a Green TDFN-3×3-10L package and operates over a temperature range of -40°C to +85°C.

FEATURES

- **Wide Input Voltage Range from 4.5V to 22V with Surge up to 30V**
- **On-Resistance: 23mΩ**
- **Selectable Input Voltage and Clamping Output Voltage Threshold**
- **Programmable Current Limit: 5A (MAX)**
- **Protection Features**
 - ◆ **Programmable Soft-Start Time**
 - ◆ **Thermal Shutdown Protection & Auto-Retry**
- **Enable Interface Pin**
- **-40°C to +85°C Operating Temperature Range**
- **Available in a Green TDFN-3×3-10L Package**

APPLICATIONS

Service PC
 Notebook PC
 iPad Mini

TYPICAL APPLICATION

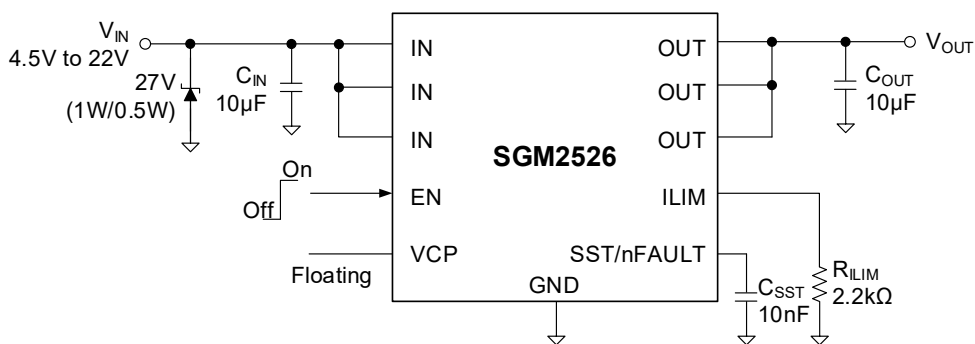

Figure 1. Typical Application Circuit

PACKAGE/ORDERING INFORMATION

MODEL	PACKAGE DESCRIPTION	SPECIFIED TEMPERATURE RANGE	ORDERING NUMBER	PACKAGE MARKING	PACKING OPTION
SGM2526	TDFN-3x3-10L	-40°C to +85°C	SGM2526YTD10G/TR	SGM 2526D XXXXX	Tape and Reel, 4000

MARKING INFORMATION

NOTE: XXXXX = Date Code and Vendor Code.

XXXXX

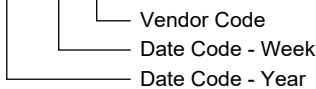

Green (RoHS & HSF): SG Micro Corp defines "Green" to mean Pb-Free (RoHS compatible) and free of halogen substances. If you have additional comments or questions, please contact your SGMICRO representative directly.

ABSOLUTE MAXIMUM RATINGS

- IN, OUT, EN, VCP to GND -0.3V to 30V
- ILIM, SST/nFAULT to GND..... -0.3V to 6V
- Package Thermal Resistance
- TDFN-3x3-10L, θ_{JA} 62°C/W
- Junction Temperature+150°C
- Storage Temperature Range..... -65°C to +150°C
- Lead Temperature (Soldering, 10s)+260°C
- ESD Susceptibility
- HBM..... 4000V
- MM..... 300V
- CDM 1000V

RECOMMENDED OPERATING CONDITIONS

- Supply Input Voltage.....4.5V to 22V
- Ambient Temperature Range..... -40°C to +85°C
- Operating Junction Temperature Range..... -40°C to +125°C

OVERSTRESS CAUTION

Stresses beyond those listed in Absolute Maximum Ratings may cause permanent damage to the device. Exposure to absolute maximum rating conditions for extended periods may affect reliability. Functional operation of the device at any conditions beyond those indicated in the Recommended Operating Conditions section is not implied.

ESD SENSITIVITY CAUTION

This integrated circuit can be damaged if ESD protections are not considered carefully. SGMICRO recommends that all integrated circuits be handled with appropriate precautions. Failure to observe proper handling and installation procedures can cause damage. ESD damage can range from subtle performance degradation to complete device failure. Precision integrated circuits may be more susceptible to damage because even small parametric changes could cause the device not to meet the published specifications.

DISCLAIMER

SG Micro Corp reserves the right to make any change in circuit design, or specifications without prior notice.

PIN CONFIGURATION

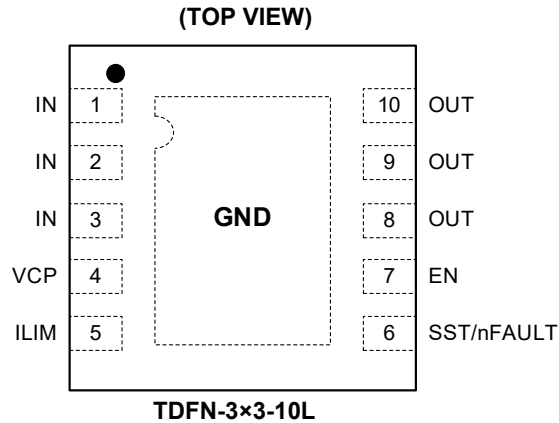

PIN DESCRIPTION

PIN	NAME	FUNCTION
1, 2, 3	IN	Power Input Pin. Place a 0.1µF decoupling ceramic capacitor between this pin and GND.
4	VCP	Output Clamp Voltage Selection Pin. Different clamp voltages can be selected according to the V_{IN} voltage. It is recommended that a 0.1µF capacitor be placed between VCP and GND. See Table 1 for details.
5	ILIM	Programming Current Limit Pin. A resistor between ILIM and GND will set the current limit value.
6	SST/nFAULT	Soft-Start Time Program and Fault Event Indicator Pin. The capacitor between SST/nFAULT and GND pins will set the slew rate according to the application requirements. If under-voltage or thermal shutdown event occurs, the device sinks current from SST/nFAULT, pulling the pin down to alert the host.
7	EN	Enable Pin. Logic high will enable the device.
8, 9, 10	OUT	Output of the Device.
Exposed Pad	GND	Ground.

Table 1. Output Clamp Voltage Selection

VCP	V_{IN} (V)		Clamping Threshold (V)		
			MIN	TYP	MAX
High	5	Over 6	5.5	5.7	5.9
Floating	12	Over 14	12.8	13.3	13.6

ELECTRICAL CHARACTERISTICS

(T_A = +25°C, V_{IN} = 5V, R_{LIM} = 10kΩ, C_{SST} = 10nF, C_{IN} = 10μF and C_{OUT} = 10μF, unless otherwise specified.)

PARAMETER	SYMBOL	CONDITIONS	MIN	TYP	MAX	UNITS
Input Voltage Range	V _{IN}		4.5		22	V
Input UVLO Threshold Voltage	V _{UVLO}	VCP = High	3.4	3.6	3.8	V
		VCP = Floating	8.2	8.6	9.0	V
UVLO Hysteresis	V _{UVHYS}	VCP = High		0.1		V
		VCP = Floating		0.2		
Bias Current	I _{BIAS}			170	200	μA
Shutdown Current	I _{SHDN}	EN = 0V		0.7	1.2	μA
FET On-Resistance	R _{DSON}			23	29	mΩ
Clamping Output Voltage	V _{CLP}	VCP = High	5.5	5.7	5.9	V
		VCP = Floating	12.8	13.2	13.6	V
Soft-Start Time ⁽¹⁾	t _{SST}	C _{SST} = 0F		1.4		ms
		C _{SST} = 10nF		2.6		ms
Soft-Start Time Accuracy ⁽¹⁾		C _{SST} = 10nF		±30% t _{SST}		
Current Limit Accuracy		R _{LIM} = 11kΩ	0.92	1.0	1.09	A
Current Limit Program Range ⁽²⁾	I _{LIM}		1		5	A
EN Turn-On Threshold Voltage	V _{EN_ON}	T _A = -40°C to +85°C	1.2			V
EN Turn-Off Threshold Voltage	V _{EN_OFF}	T _A = -40°C to +85°C			0.4	V
Thermal Shutdown Temperature	T _{SD}			150		°C
Thermal Shutdown Hysteresis	T _{HYS}			20		°C

NOTE 1:

$$t_{SST} = t_{SST_DLT} \text{ (No External } C_{SST} \text{)} \quad (1)$$

$$t_{SST} = \frac{C_{SST}}{I_{INT}} \times 1.2 \text{ (} t_{SST} > t_{SST_DLT} \text{)} \quad (2)$$

where:

t_{SST_DLT} is the internally fixed default soft-start time (about 1.4ms) without any external C_{SST}.

I_{INT} is the internal current source (about 4.6μA).

A capacitor (C_{SST}) of less than 10nF is recommended.

NOTE 2:

Recommended Current Limit Program Table:

Current Limit (A)	R _{LIM} (kΩ)
1.0	11
2.0	5.5
2.5	4.4
3.0	3.7
3.5	3.1
4.0	2.8
4.5	2.4
5.0	2.2

Recommended Formula for R_{LIM} & Current Limit Calculation:

$$R_{LIM} = \frac{11}{I_{LIM}} \text{ (k}\Omega \text{)} \quad (3)$$

TYPICAL PERFORMANCE CHARACTERISTICS

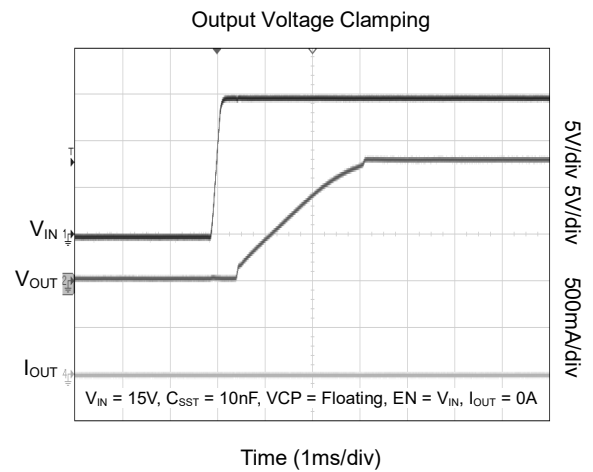
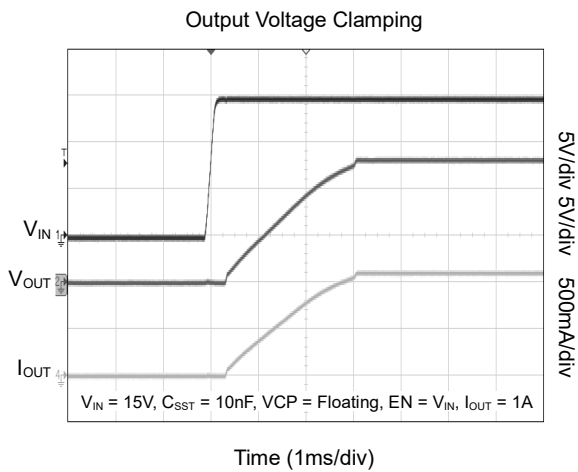
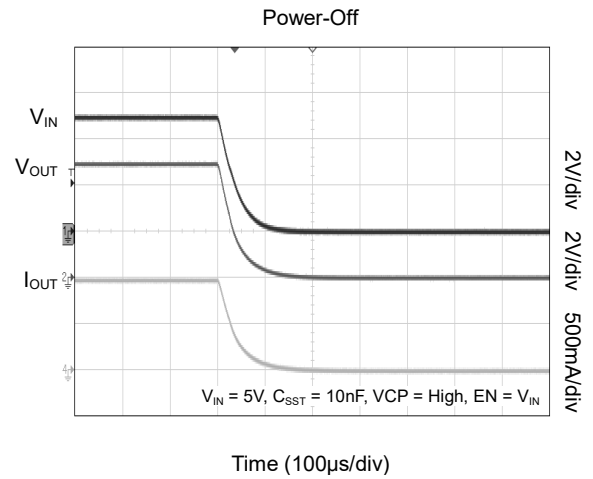
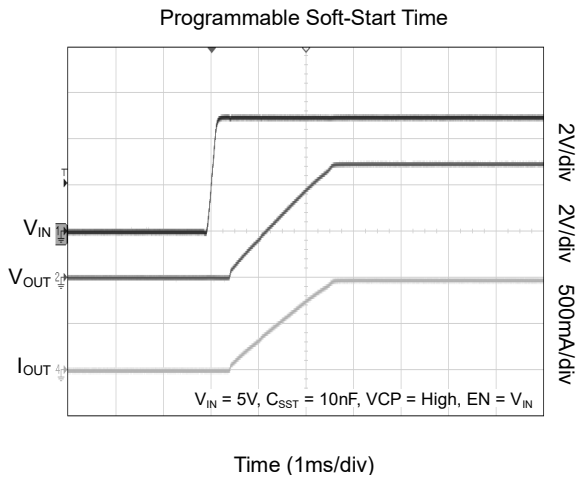
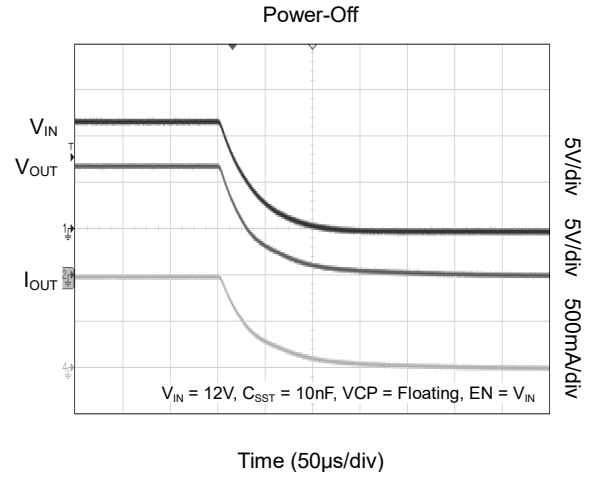
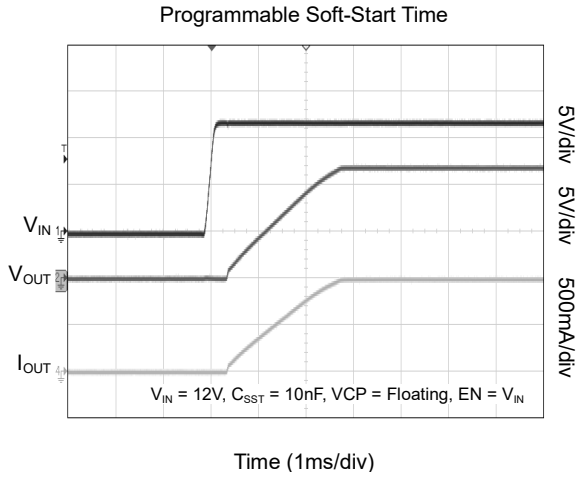

TYPICAL PERFORMANCE CHARACTERISTICS (continued)

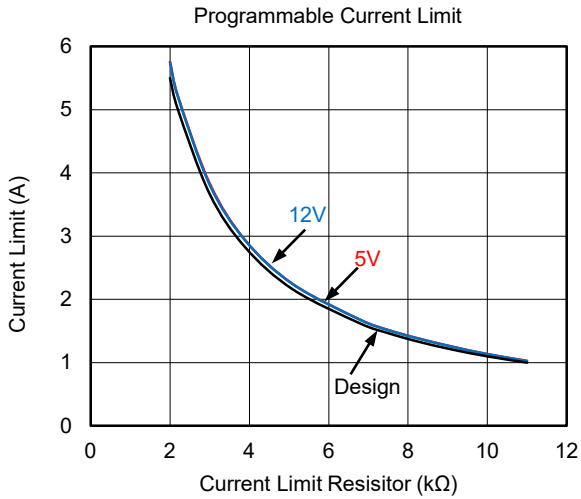
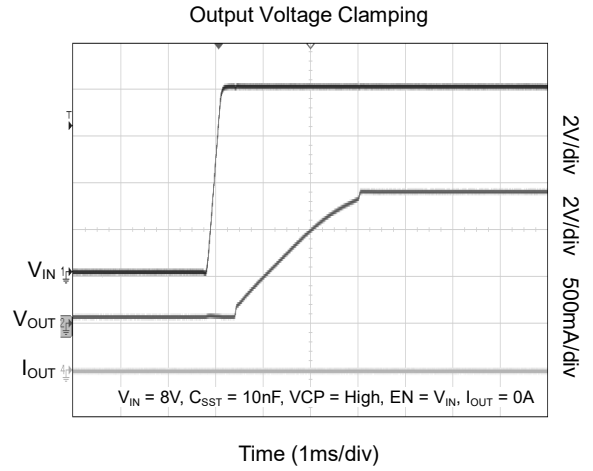
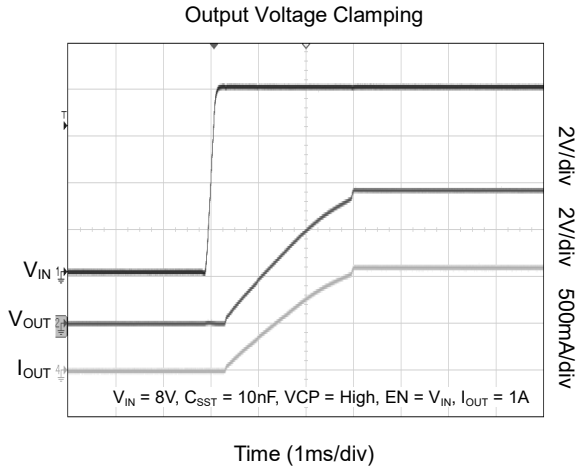

FUNCTIONAL BLOCK DIAGRAM

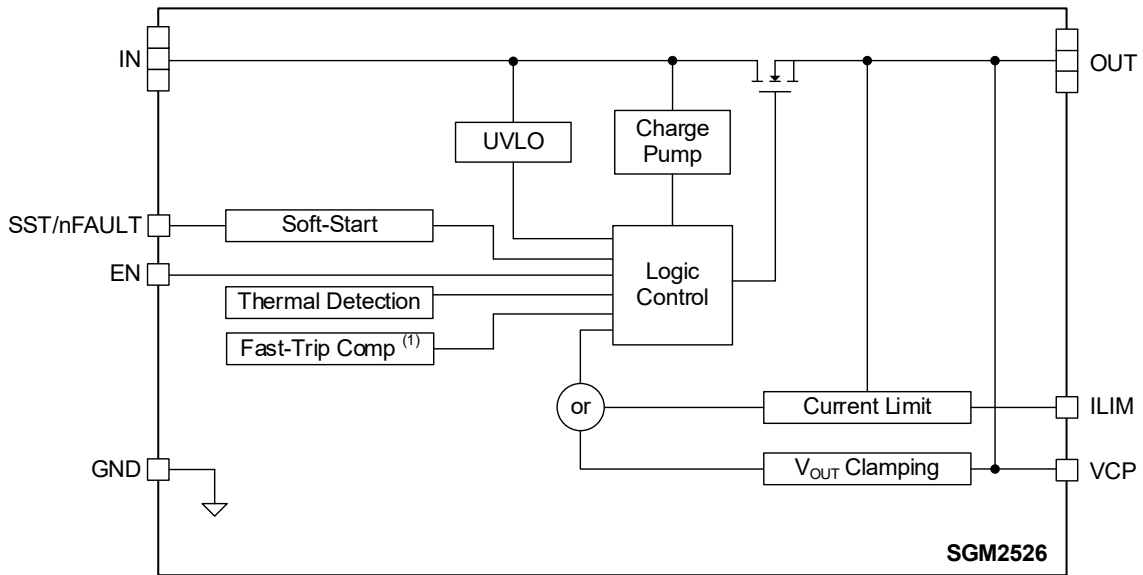

NOTES:

1. During the operation of SGM2526, its output may short to ground in some abnormal conditions. As a result, the current through the device increases very rapidly. The internal current limit amplifier provides the accurate current limit control while its bandwidth is limited. So it cannot respond quickly enough to this event. Therefore, the SGM2526 offers a dedicated fast-trip comparator, which shuts down the pass device very quickly when $I_{OUT} > I_{FAST-TRIP}$ ($I_{FAST-TRIP} = 1.8 \times I_{LIM}$), and terminates the rapid short-circuit peak current. After the output short peak current has been terminated by the fast-trip comparator, the current limit amplifier smoothly regulates the output current to I_{LIM} .
2. When the switching voltage of SGM2526 is more than 15V, customer should add a no more than 27V (> 0.5W) Zener diode to prevent the input voltage spike from damaging the SGM2526.

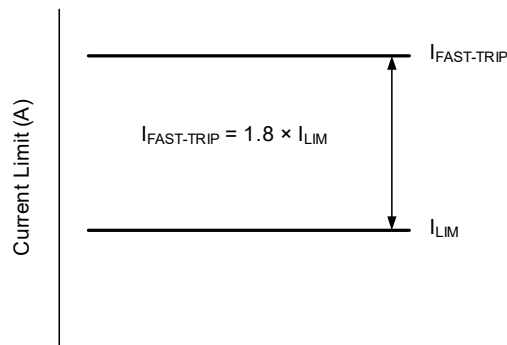

APPLICATION EXAMPLES

The SGM2526 provides a complete set of protection functions for overload or inrush current. The wide operating voltage range (4.5V to 22V) is specifically designed for many popular DC buses, and the maximum load current of 5A can meet the power delivery requirements of many devices.

Protection and Current Limit for AC/DC Power Supplies

In many small household appliances, portable devices, consumer products and other application scenarios, the primary-side power supplies and adapter are dominant.

- No secondary-side protection which can stop short-circuit and other key faults immediately.
- Cannot provide precision current limit for overload transients.
- Poor ability to regulate the output voltage during sudden fluctuation of the AC input voltage, when the output over-voltage condition is triggered.

Therefore, accurate current sensing and overload protection are required for the secondary side output port in the above applications. This requires the use of precision operational amplifiers for additional circuit

implementation. It adds complexity to the solution and leads to a loss of sensing. The SGM2526 adopting N-MOSFET with low on-resistance is a simple and efficient solution. The typical application circuit of SGM2526 is shown in Figure 2.

Precision Current Limit in Intrinsic Safety Applications

The safe operation of electrical and electronic equipment in dangerous area environment has a more and more urgent requirements for intensive safety (IS). IS requires that the total energy available during equipment operation is not enough to ignite the surrounding explosive environment by means of electric sparks or heat transfer. This requires precision current limits to ensure that the set current limits are not exceeded over a wide operating temperature range and variable environmental conditions. Applications such as gas analyzers, medical devices, portal industrial equipment, etc., need to meet these importance safety standards. As a simple over-voltage and over-load protection solution, the SGM2526 is applicable to each power rail inside the system application. The typical implementation circuit of SGM2526 is shown in Figure 3.

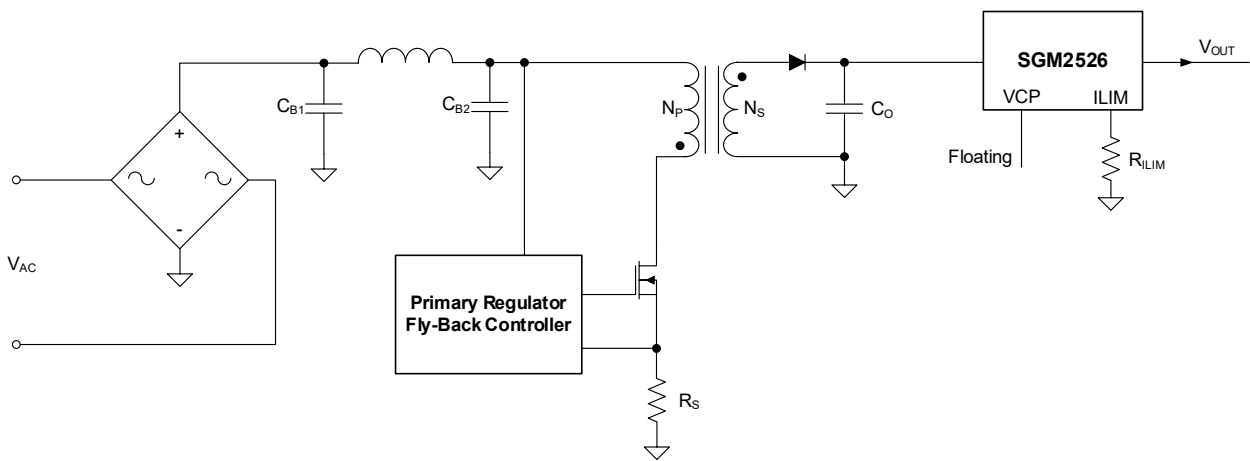

Figure 2. Current Limit and Protection for AC/DC Power Supplies

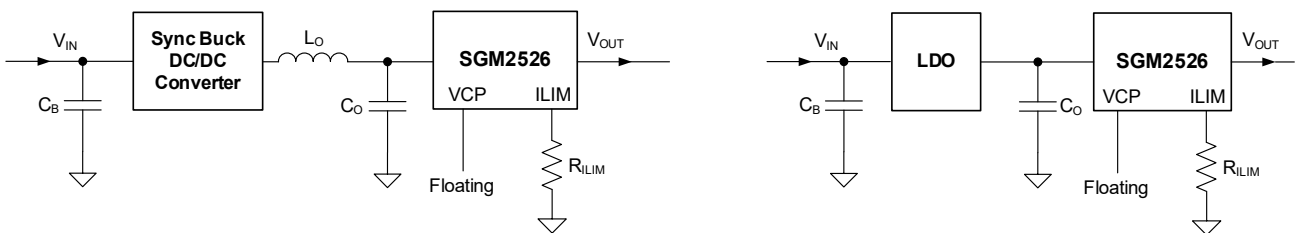

Figure 3. Precision Current Limit and Protection of Internal Rails

APPLICATION EXAMPLES (continued)

Smart Load Switch

The smart load switch is a series of MOSFETs used to switch the load (resistance or capacitance). It also provides protection in case of failure. Figure 4 shows a typical discrete implementation of load switch, which requires more components and more complex circuits

to achieve fault protection. The SGM2526 can be used as a load switch for the applications whose operating range is from 4.5V to 22V. Programmable current limits, programmable soft-start, over-temperature protection, fault flag and under-voltage lockout are provided in the SGM2526.

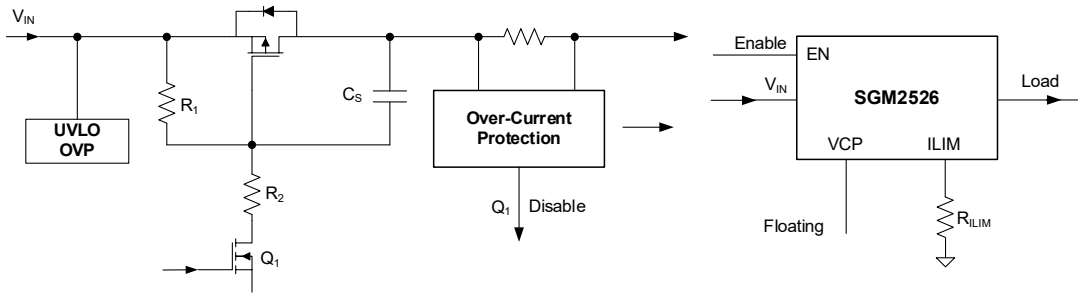

Figure 4. Smart Load Switch Implementation

REVISION HISTORY

NOTE: Page numbers for previous revisions may differ from page numbers in the current version.

Revision	Page
FEBRUARY 2024 – REV.A.1 to REV.A.2	
Updated General Description and Application Examples sections	All
MAY 2019 – REV.A to REV.A.1	
Updated Figure 1, Figure 2, Figure 3 and Figure 4	1, 8, 9, 10
Changes from Original (DECEMBER 2018) to REV.A	
Changed from product preview to production data	All

PACKAGE OUTLINE DIMENSIONS

TDFN-3x3-10L

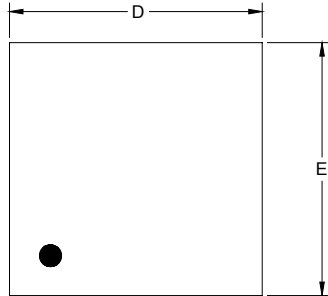

TOP VIEW

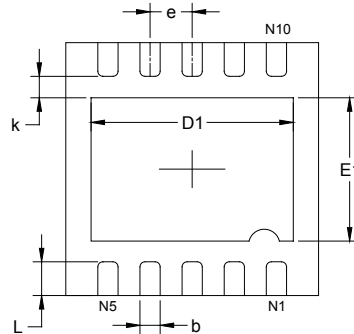

BOTTOM VIEW

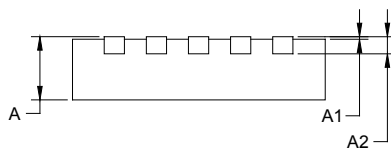

SIDE VIEW

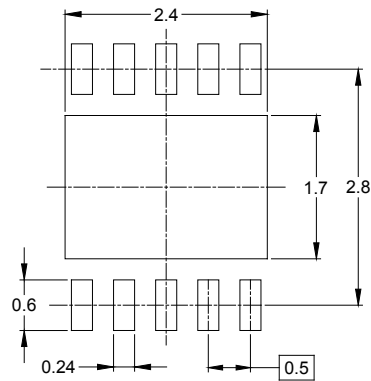

RECOMMENDED LAND PATTERN (Unit: mm)

Symbol	Dimensions In Millimeters		Dimensions In Inches	
	MIN	MAX	MIN	MAX
A	0.700	0.800	0.028	0.031
A1	0.000	0.050	0.000	0.002
A2	0.203 REF		0.008 REF	
D	2.900	3.100	0.114	0.122
D1	2.300	2.600	0.091	0.103
E	2.900	3.100	0.114	0.122
E1	1.500	1.800	0.059	0.071
k	0.200 MIN		0.008 MIN	
b	0.180	0.300	0.007	0.012
e	0.500 TYP		0.020 TYP	
L	0.300	0.500	0.012	0.020

PACKAGE INFORMATION

TAPE AND REEL INFORMATION

REEL DIMENSIONS



TAPE DIMENSIONS



NOTE: The picture is only for reference. Please make the object as the standard.

KEY PARAMETER LIST OF TAPE AND REEL

Package Type	Reel Diameter	Reel Width W1 (mm)	A0 (mm)	B0 (mm)	K0 (mm)	P0 (mm)	P1 (mm)	P2 (mm)	W (mm)	Pin1 Quadrant
TDFN-3×3-10L	13"	12.4	3.35	3.35	1.13	4.0	8.0	2.0	12.0	Q1

000001

PACKAGE INFORMATION

CARTON BOX DIMENSIONS



NOTE: The picture is only for reference. Please make the object as the standard.

KEY PARAMETER LIST OF CARTON BOX

Reel Type	Length (mm)	Width (mm)	Height (mm)	Pizza/Carton
13"	386	280	370	5

DD0002