

### GENERAL DESCRIPTION

The SGM2533 and SGM2534 are compact, feature rich eFuses with a full suite of protection functions. The precision  $\pm 15\%$  current limit provides excellent accuracy and makes the devices well suited for many system protection applications.

There are two over-voltage protection options: 5V system for SGM2533 and 12V system for SGM2534. The over-voltage protection (OVP) will clamp the eFuse output at a fixed level during input voltage surges. During the input voltage transient, the internal MOSFET remains on, allowing the load to continue to operate. If the transient duration remains long, the accumulated heat will cause the eFuse thermal shutdown. Once in thermal shutdown, latch-off and auto-retry thermal options are available.

The SGM2533 and SGM2534 are available in a Green TDFN-3x3-10L package.

### FEATURES

- **5V Electronic Fuse (eFuse): SGM2533A/B**
- **12V Electronic Fuse (eFuse): SGM2534A/B**
- **$R_{DS(ON)}$  Protection Switch: 26m $\Omega$  (TYP)**
- **Fixed Over-Voltage Clamp:**
  - ◆ **6.1V Clamp: SGM2533A/B**
  - ◆ **15V Clamp: SGM2534A/B**
- **Programmable Current Limit: 2A to 5A ( $\pm 15\%$  Accuracy)**
- **Under-Voltage Lockout**
- **Programmable  $V_{OUT}$  Slew Rate**
- **Thermal Shutdown Protection**
  - ◆ **Auto-Retry: SGM2533A/SGM2534A**
  - ◆ **Latch-Off: SGM2533B/SGM2534B**
- **Available in a Green TDFN-3x3-10L Package**

### APPLICATIONS

Servers and Block Supplies  
 Motherboard Power Management  
 PCIE SSD

### TYPICAL APPLICATION

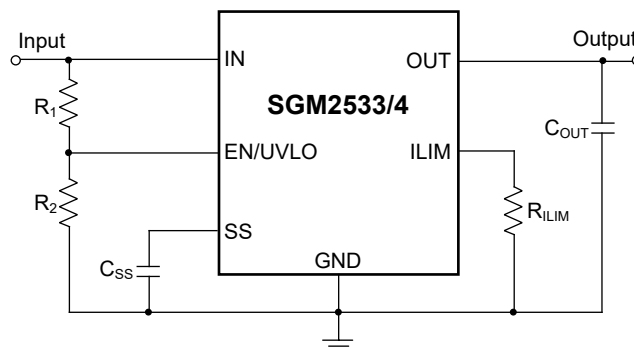

Figure 1. Typical Application Circuit

**PACKAGE/ORDERING INFORMATION**

MODEL	PACKAGE DESCRIPTION	SPECIFIED TEMPERATURE RANGE	ORDERING NUMBER	PACKAGE MARKING	PACKING OPTION
SGM2533A	TDFN-3×3-10L	-40°C to +125°C	SGM2533AXTD10G/TR	SGM 2533AD XXXXX	Tape and Reel, 4000
SGM2533B	TDFN-3×3-10L	-40°C to +125°C	SGM2533BXTD10G/TR	SGM 2533BD XXXXX	Tape and Reel, 4000
SGM2534A	TDFN-3×3-10L	-40°C to +125°C	SGM2534AXTD10G/TR	SGM 2534AD XXXXX	Tape and Reel, 4000
SGM2534B	TDFN-3×3-10L	-40°C to +125°C	SGM2534BXTD10G/TR	SGM 2534BD XXXXX	Tape and Reel, 4000

**MARKING INFORMATION**

NOTE: XXXXX = Date Code, Trace Code and Vendor Code.

**XXXXX**

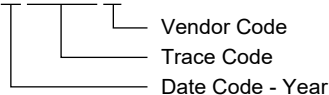

Green (RoHS & HSF): SG Micro Corp defines "Green" to mean Pb-Free (RoHS compatible) and free of halogen substances. If you have additional comments or questions, please contact your SGMICRO representative directly.

**ABSOLUTE MAXIMUM RATINGS**

Supply Voltage Range	
$V_{IN}$ .....	-0.3V to 20V
$V_{IN}$ (Transient < 1ms) .....	22V
Output Voltage Range	
$V_{OUT}$ .....	-0.3V to $V_{IN} + 0.3V$
$V_{OUT}$ (Transient < 1 $\mu$ s) .....	-1.2V
ILIM Voltage .....	-0.3V to 7V
SS, EN/UVLO Voltage .....	-0.3V to 7V
Continuous Output Current, $I_{OUT}$ .....	6.25A
Package Thermal Resistance	
TDFN-3×3-10L, $\theta_{JA}$ .....	54°C/W
Junction Temperature .....	+150°C
Storage Temperature Range .....	-65°C to +150°C
Lead Temperature (Soldering, 10s) .....	+260°C
ESD Susceptibility	
HBM .....	4000V
CDM .....	1000V

**RECOMMENDED OPERATING CONDITIONS**

Supply Voltage Range	
$V_{IN}$ (SGM2533) .....	4.5V to 5.5V
$V_{IN}$ (SGM2534) .....	4.5V to 13.8V
SS, EN/UVLO Voltage .....	0V to 6V
ILIM Voltage .....	0V to 3V
Continuous Output Current, $I_{OUT}$ .....	0A to 5A
Resistance, $R_{ILIM}$ .....	10k $\Omega$ to 162k $\Omega$

External Capacitance

$C_{OUT}$ .....	0.1 $\mu$ F to 1000 $\mu$ F
$C_{SS}$ .....	< 1000nF
Operating Junction Temperature Range .....	-40°C to +125°C
Operating Ambient Temperature Range .....	-40°C to +125°C

**OVERSTRESS CAUTION**

Stresses beyond those listed in Absolute Maximum Ratings may cause permanent damage to the device. Exposure to absolute maximum rating conditions for extended periods may affect reliability. Functional operation of the device at any conditions beyond those indicated in the Recommended Operating Conditions section is not implied.

**ESD SENSITIVITY CAUTION**

This integrated circuit can be damaged if ESD protections are not considered carefully. SGMICRO recommends that all integrated circuits be handled with appropriate precautions. Failure to observe proper handling and installation procedures can cause damage. ESD damage can range from subtle performance degradation to complete device failure. Precision integrated circuits may be more susceptible to damage because even small parametric changes could cause the device not to meet the published specifications.

**DISCLAIMER**

SG Micro Corp reserves the right to make any change in circuit design, or specifications without prior notice.

**PIN CONFIGURATION**

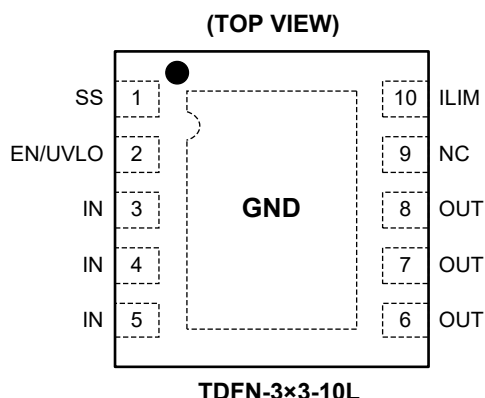

**PIN DESCRIPTION**

PIN	NAME	FUNCTION
1	SS	Soft-Start Pin. The capacitor between SS and GND pins will set the slew rate according to the application requirements.
2	EN/UVLO	Enable Input or Under-Voltage Lockout. Asserting EN/UVLO pin high enables the device. As an UVLO pin, the UVLO threshold is programmed by an external resistor divider.
3, 4, 5	IN	Power Input Pin. Power input and supply voltage of the device.
6, 7, 8	OUT	Power Output Pin.
9	NC	No Connection.
10	ILIM	Current Limit Programming Pin. A resistor between this pin and GND sets the overload and short-circuit current limit levels.
Exposed Pad	GND	Ground.

**ELECTRICAL CHARACTERISTICS**

(T<sub>J</sub> = -40°C to +125°C, V<sub>IN</sub> = 5V for SGM2533, V<sub>IN</sub> = 12V for SGM2534, V<sub>EN/UVLO</sub> = 2V, R<sub>ILIM</sub> = 100kΩ, C<sub>SS</sub> = Open. All voltages referenced to GND, unless otherwise noted.)

PARAMETER	SYMBOL	CONDITIONS	MIN	TYP	MAX	UNITS
<b>Supply Voltage (IN)</b>						
UVLO Threshold, Rising	V <sub>UVR</sub>		4.1	4.3	4.5	V
UVLO Hysteresis <sup>(1)</sup>	V <sub>UVHYS</sub>			210		mV
Supply Current	I <sub>Q_ON</sub>	SGM2533: V <sub>EN/UVLO</sub> = 2V	120	175	237	μA
		SGM2534: V <sub>EN/UVLO</sub> = 2V	126	185	242	
	I <sub>Q_OFF</sub>	V <sub>EN/UVLO</sub> = 0V		1.1	4	μA
Over-Voltage Clamp	V <sub>OVC</sub>	SGM2533: V <sub>IN</sub> > 6.75V, I <sub>OUT</sub> = 10mA	5.5	6.15	6.7	V
		SGM2534: V <sub>IN</sub> > 16.5V, I <sub>OUT</sub> = 10mA	13.8	14.86	15.9	
<b>Enable and Under-Voltage Lockout Input (EN/UVLO)</b>						
EN/UVLO Threshold Voltage, Rising	V <sub>ENR</sub>		1.33	1.4	1.48	V
EN/UVLO Threshold Voltage, Falling	V <sub>ENF</sub>		1.27	1.35	1.42	V
EN/UVLO Input Leakage Current	I <sub>EN</sub>	0V ≤ V <sub>EN/UVLO</sub> ≤ 7V	-1.5	0	1.5	μA
<b>Output Ramp Control (SS)</b>						
SS Charging Current <sup>(1)</sup>	I <sub>SS</sub>	V <sub>SS</sub> = 0V		223		nA
SS Discharging Resistance	R <sub>SS</sub>	V <sub>EN/UVLO</sub> = 0V, I <sub>SS</sub> = 10mA sinking	45	74	105	Ω
SS Maximum Capacitor Voltage <sup>(1)</sup>	V <sub>SSMAX</sub>			5		V
SS to OUT Gain <sup>(1)</sup>	GAIN <sub>SS</sub>	ΔV <sub>SS</sub>		4.84		V/V
<b>Current Limit Programming (ILIM)</b>						
ILIM Bias Current <sup>(1)</sup>	I <sub>ILIM</sub>			10		μA
Overload Current Limit	I <sub>OL</sub>	R <sub>ILIM</sub> = 45.3kΩ, V <sub>IN-OUT</sub> = 1V	1.87	1.97	2.53	A
		R <sub>ILIM</sub> = 100kΩ, V <sub>IN-OUT</sub> = 1V	3.40	3.75	4.05	
		R <sub>ILIM</sub> = 150kΩ, V <sub>IN-OUT</sub> = 1V	4.32	5.07	5.83	
	I <sub>OL-R-SHORT</sub>	R <sub>ILIM</sub> = 0Ω, shorted resistor current limit <sup>(1)</sup>		0.87		A
	I <sub>OL-R-OPEN</sub>	R <sub>ILIM</sub> = Open, open resistor current limit <sup>(1)</sup>		7		A
Short-Circuit Current Limit	I <sub>SC</sub>	SGM2533: R <sub>ILIM</sub> = 45.3kΩ, V <sub>IN-OUT</sub> = 5V	1.64	2.22	2.79	A
		SGM2534: R <sub>ILIM</sub> = 45.3kΩ, V <sub>IN-OUT</sub> = 12V	1.50	2.27	2.98	
		SGM2533: R <sub>ILIM</sub> = 100kΩ, V <sub>IN-OUT</sub> = 5V	3	3.81	4.62	
		SGM2534: R <sub>ILIM</sub> = 100kΩ, V <sub>IN-OUT</sub> = 12V	2.12	3.70	5.25	
		SGM2533: R <sub>ILIM</sub> = 150kΩ, V <sub>IN-OUT</sub> = 5V	3.96	5.32	6.66	
		SGM2534: R <sub>ILIM</sub> = 150kΩ, V <sub>IN-OUT</sub> = 12V	1.32	3.72	6.18	
Fast-Trip Comparator Threshold <sup>(1)</sup>	I <sub>FAST-TRIP</sub>	R <sub>ILIM</sub> in kΩ		1.6 × I <sub>OL</sub>		A
ILIM Open Resistor Detect Threshold <sup>(1)</sup>	V <sub>ILIM_OPEN</sub>	V <sub>ILIM</sub> Rising, R <sub>ILIM</sub> = Open		2.2		V
<b>Pass FET Output (OUT)</b>						
FET On-Resistance	R <sub>DSON</sub>	T <sub>J</sub> = +25°C	17	26	35	mΩ
		T <sub>J</sub> = -40°C to +125°C		26	54	
OUT Bias Current in Off State	I <sub>OUT_LKG</sub>	V <sub>EN/UVLO</sub> = 0V, V <sub>OUT</sub> = 0V (Sourcing)	-2	0	2	μA
	I <sub>OUT_SINK</sub>	V <sub>EN/UVLO</sub> = 0V, V <sub>OUT</sub> = 300mV (Sinking)	-1	0	1	
<b>Thermal Shutdown (TSD)</b>						
Thermal Shutdown Threshold, Rising <sup>(1)</sup>	T <sub>TSD</sub>			155		°C
Thermal Shutdown Hysteresis <sup>(1)</sup>	T <sub>HYS</sub>			20		°C

NOTE: 1. Guaranteed by design.

**TIMING REQUIREMENTS**

( $T_J = -40^{\circ}\text{C}$  to  $+125^{\circ}\text{C}$ ,  $V_{IN} = 5\text{V}$  for SGM2533,  $V_{IN} = 12\text{V}$  for SGM2534,  $V_{EN/UVLO} = 2\text{V}$ ,  $R_{ILIM} = 100\text{k}\Omega$ ,  $C_{SS} = \text{Open}$ . All voltages referenced to GND, unless otherwise noted.)

PARAMETER	SYMBOL	CONDITIONS	MIN	TYP	MAX	UNITS
Turn-On Delay <sup>(1)</sup>	$t_{ON\_DLY}$	EN/UVLO $\uparrow$ to $I_{IN} = 100\text{mA}$ , 1A resistive load at OUT		120		$\mu\text{s}$
Turn-Off Delay <sup>(1)</sup>	$t_{OFF\_DLY}$	EN/UVLO $\downarrow$		2		$\mu\text{s}$
<b>Output Ramp Control (SS)</b>						
Output Ramp Time	$t_{SS}$	SGM2533: EN/UVLO $\uparrow$ to $V_{OUT} = 4.9\text{V}$ , $C_{SS} = 0\text{nF}$	0.27	0.46	0.64	ms
		SGM2533: EN/UVLO $\uparrow$ to $V_{OUT} = 4.9\text{V}$ , $C_{SS} = 1\text{nF}$ <sup>(1)</sup>		5		
		SGM2534: EN/UVLO $\uparrow$ to $V_{OUT} = 11.7\text{V}$ , $C_{SS} = 0\text{nF}$	0.60	1.04	1.50	
		SGM2534: EN/UVLO $\uparrow$ to $V_{OUT} = 11.7\text{V}$ , $C_{SS} = 1\text{nF}$ <sup>(1)</sup>		12		
<b>Current Limit Programming (ILIM)</b>						
Fast-Trip Comparator Delay <sup>(1)</sup>	$t_{FAST\_TRIP\_DLY}$	$I_{OUT} > I_{FAST\_TRIP}$ to $I_{OUT} = 0$ (Switch off)		300		ns
<b>Thermal Shutdown (TSD)</b>						
Retry Delay after Thermal Shutdown Recovery, $T_J < [T_{TSD} - 20^{\circ}\text{C}]$ <sup>(1)</sup>	$t_{TSD\_DLY}$	SGM2533A and SGM2534A: $V_{IN} = 5\text{V}$		490		ms
		SGM2533A and SGM2534A: $V_{IN} = 12\text{V}$		580		

NOTE: 1. Guaranteed by design.

**FUNCTIONAL BLOCK DIAGRAM**

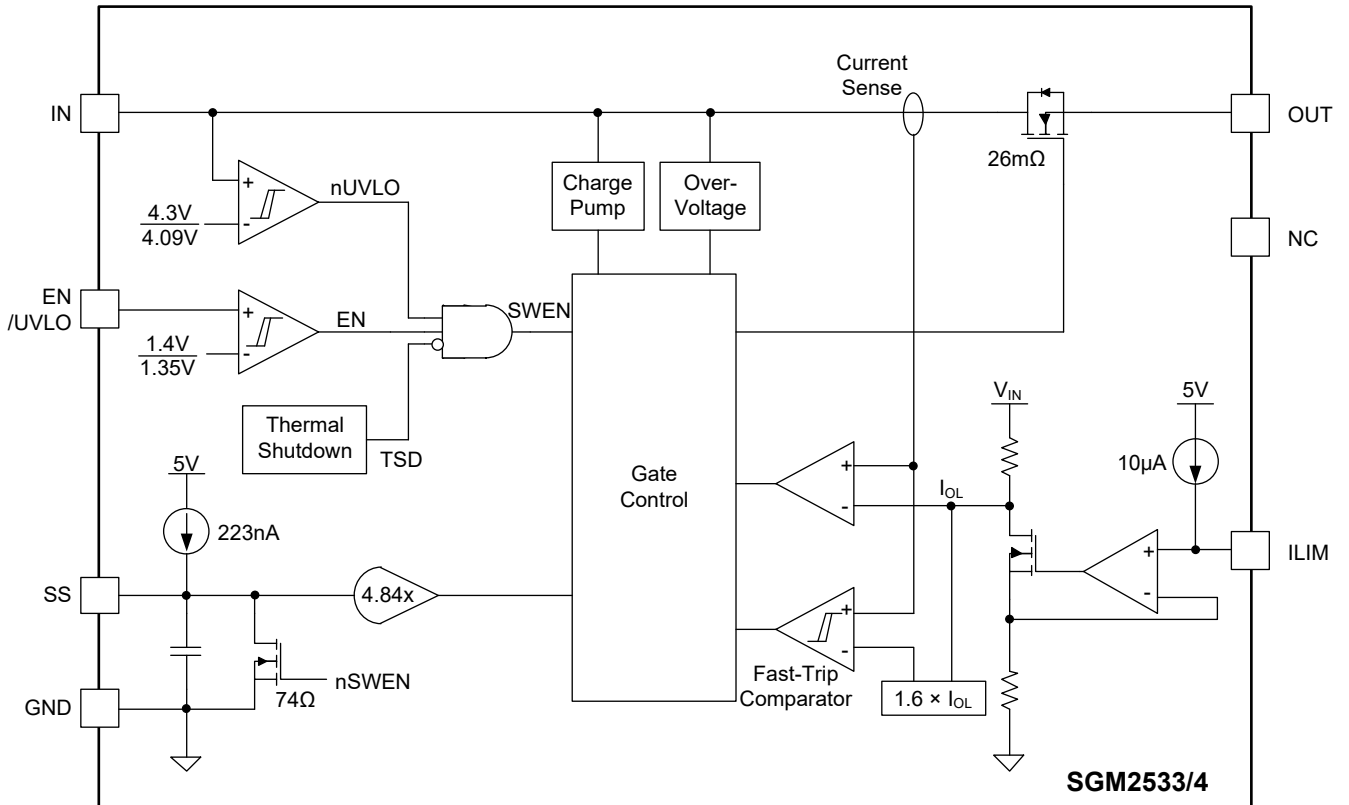
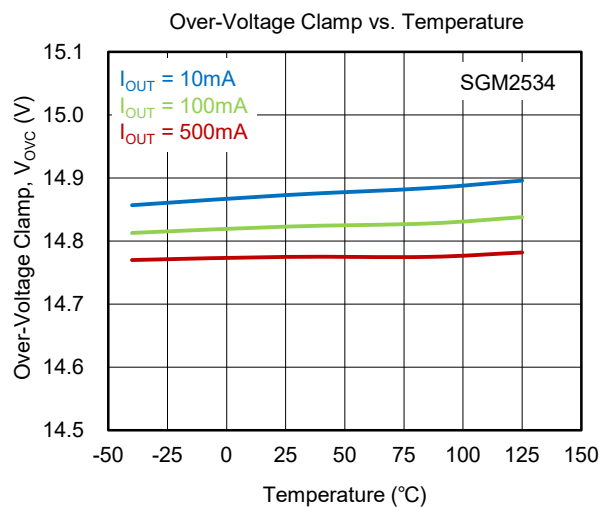
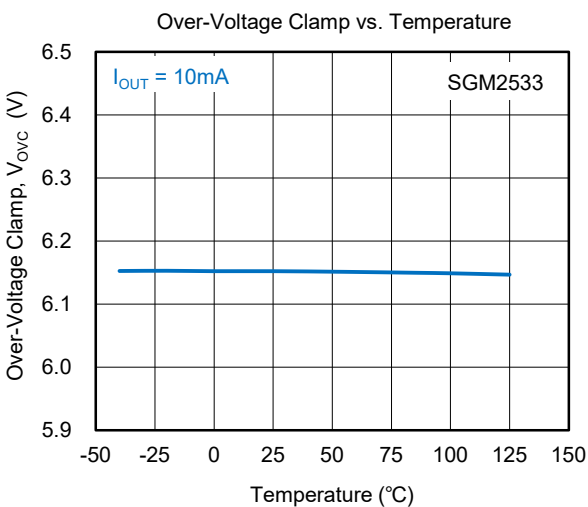
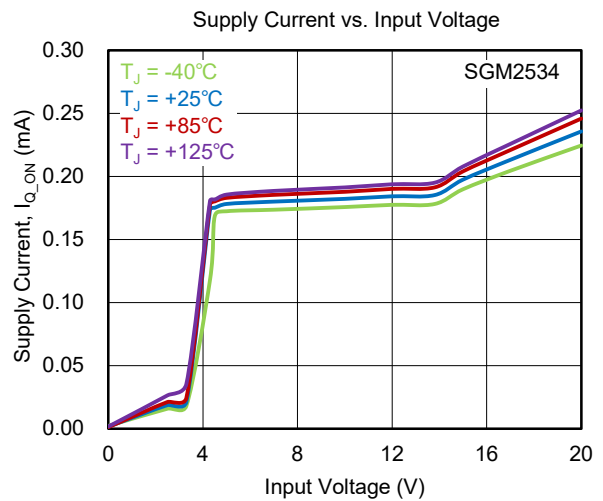
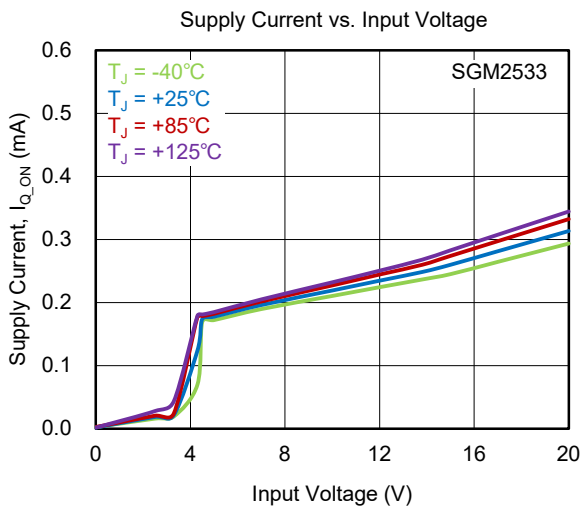
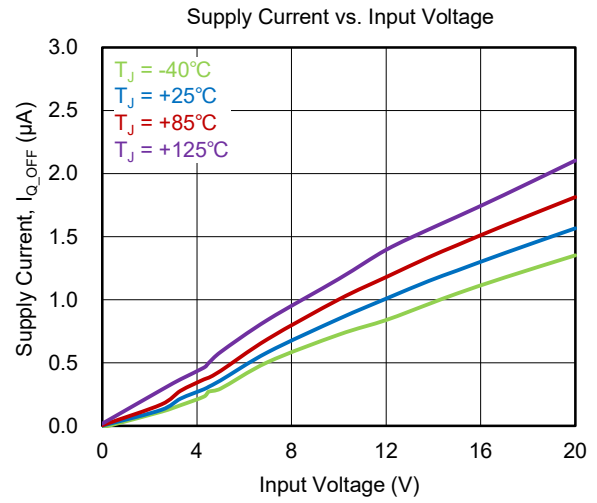
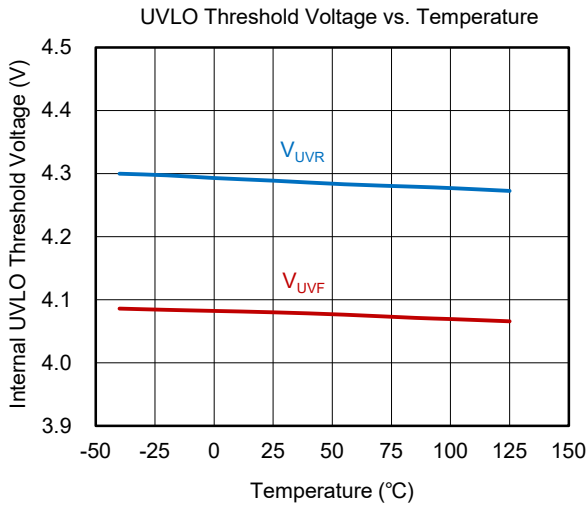

Figure 2. SGM2533/4 Block Diagram

**TYPICAL PERFORMANCE CHARACTERISTICS**

$T_J = +25^\circ\text{C}$ ,  $V_{IN} = 5\text{V}$  for SGM2533,  $V_{IN} = 12\text{V}$  for SGM2534,  $V_{EN/UVLO} = 2\text{V}$ ,  $R_{LIM} = 100\text{k}\Omega$ ,  $C_{SS} = \text{Open}$ ,  $C_{IN} = 0.1\mu\text{F}$ ,  $C_{OUT} = 1\mu\text{F}$ , unless otherwise noted.



**TYPICAL PERFORMANCE CHARACTERISTICS (continued)**

$T_J = +25^\circ\text{C}$ ,  $V_{IN} = 5\text{V}$  for SGM2533,  $V_{IN} = 12\text{V}$  for SGM2534,  $V_{EN/UVLO} = 2\text{V}$ ,  $R_{ILIM} = 100\text{k}\Omega$ ,  $C_{SS} = \text{Open}$ ,  $C_{IN} = 0.1\mu\text{F}$ ,  $C_{OUT} = 1\mu\text{F}$ , unless otherwise noted.

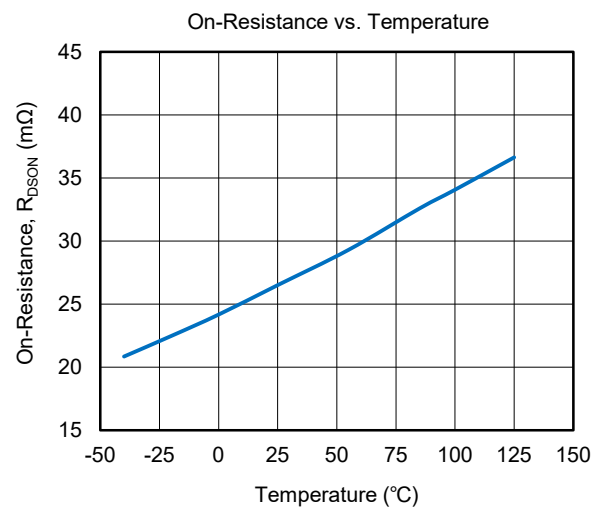
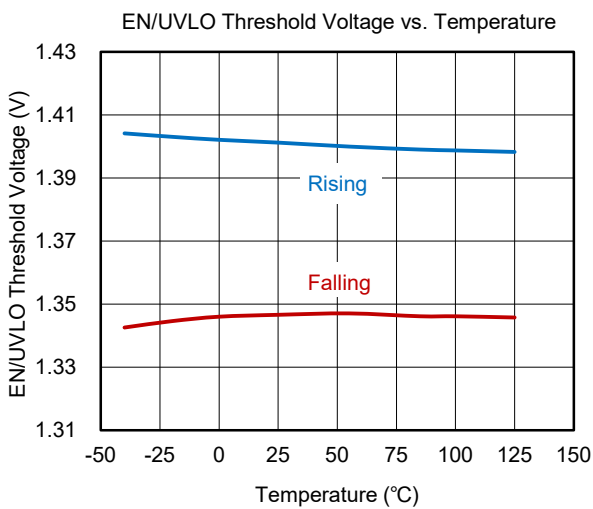
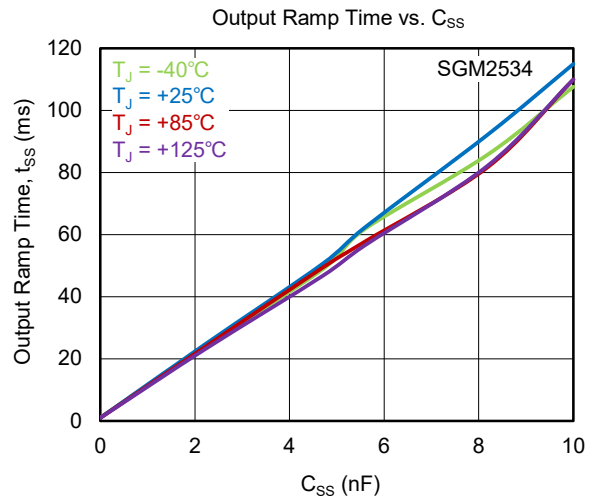
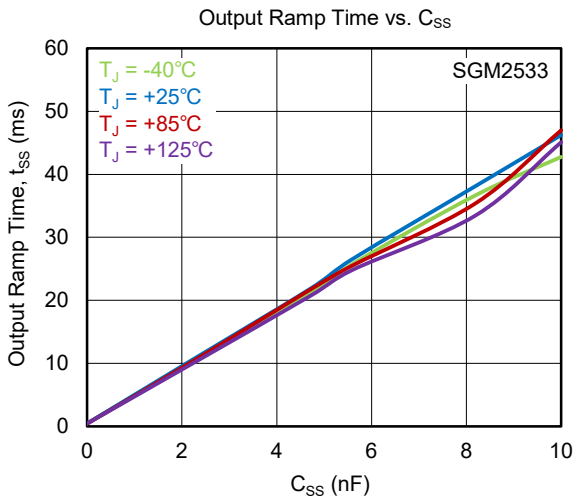
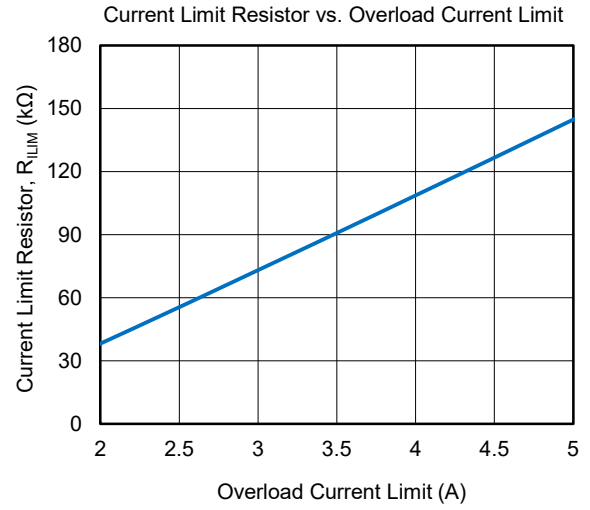
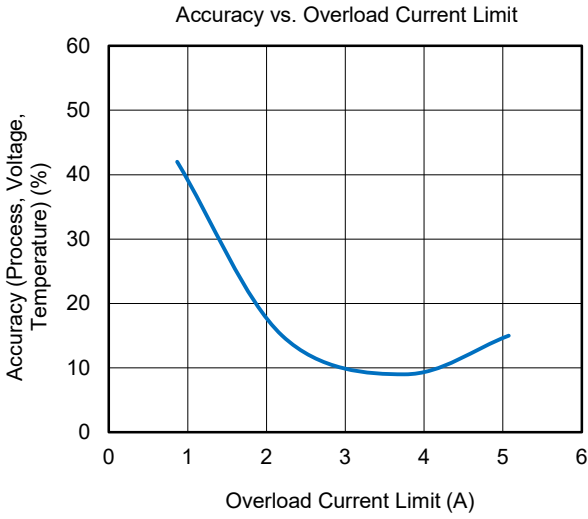



**TYPICAL PERFORMANCE CHARACTERISTICS (continued)**

$T_J = +25^\circ\text{C}$ ,  $V_{IN} = 5\text{V}$  for SGM2533,  $V_{IN} = 12\text{V}$  for SGM2534,  $V_{EN/UVLO} = 2\text{V}$ ,  $R_{LIM} = 100\text{k}\Omega$ ,  $C_{SS} = \text{Open}$ ,  $C_{IN} = 0.1\mu\text{F}$ ,  $C_{OUT} = 1\mu\text{F}$ , unless otherwise noted.

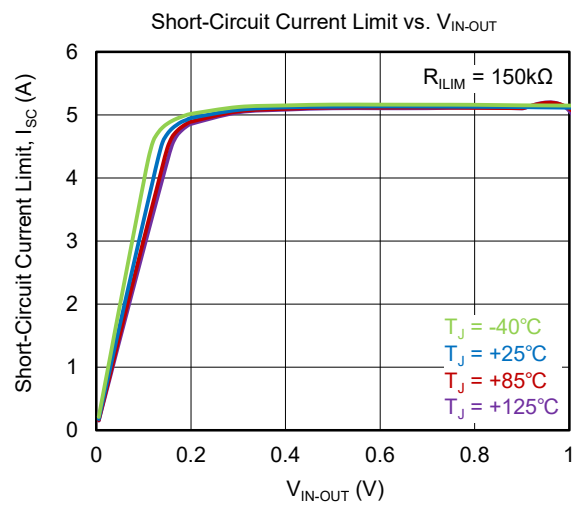
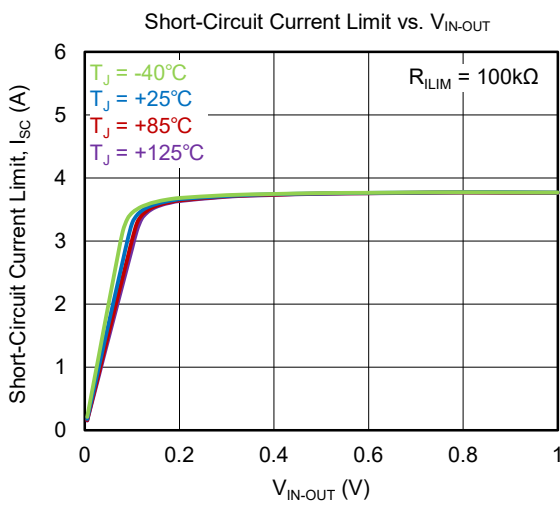
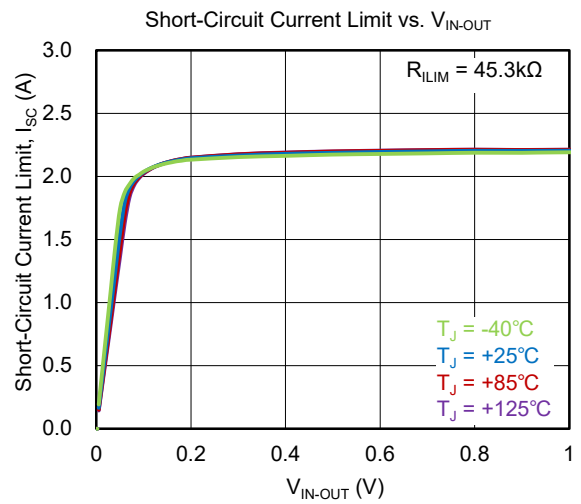
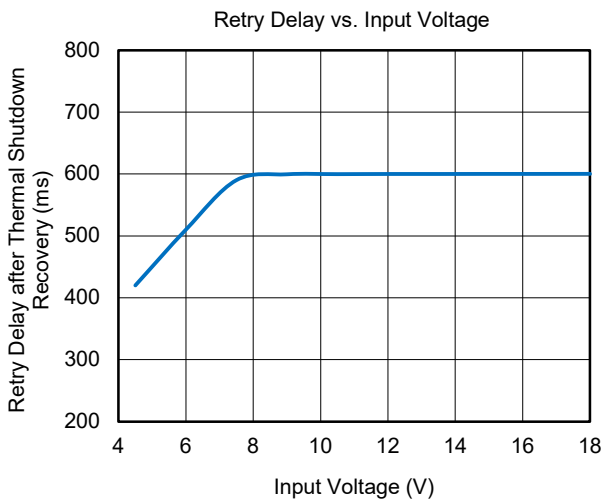
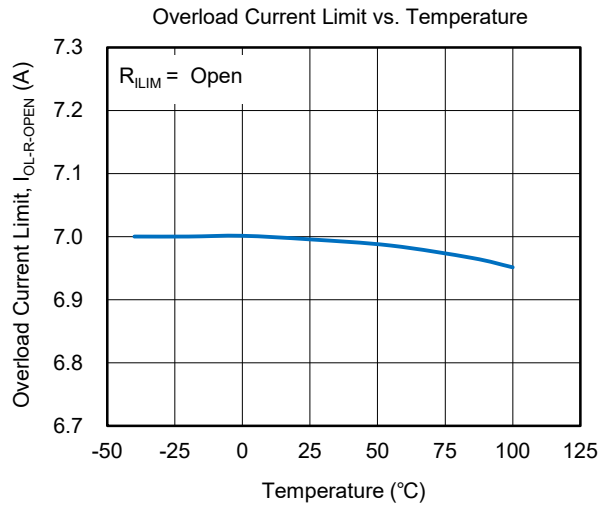
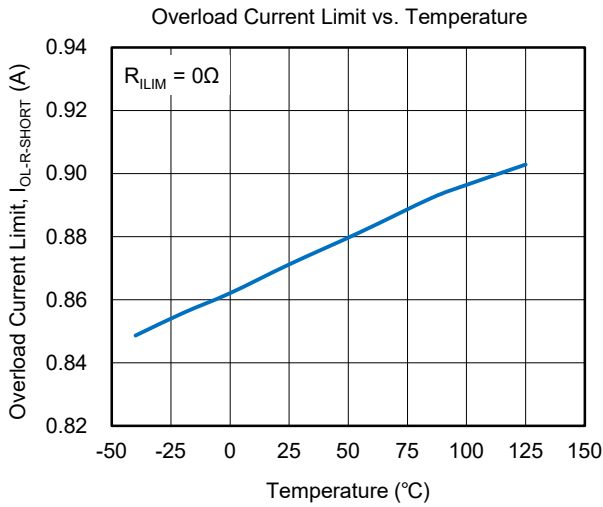

**TYPICAL PERFORMANCE CHARACTERISTICS (continued)**

$T_J = +25^\circ\text{C}$ ,  $V_{IN} = 5\text{V}$  for SGM2533,  $V_{IN} = 12\text{V}$  for SGM2534,  $V_{EN/UVLO} = 2\text{V}$ ,  $R_{ILIM} = 100\text{k}\Omega$ ,  $C_{SS} = \text{Open}$ ,  $C_{IN} = 0.1\mu\text{F}$ ,  $C_{OUT} = 1\mu\text{F}$ , unless otherwise noted.

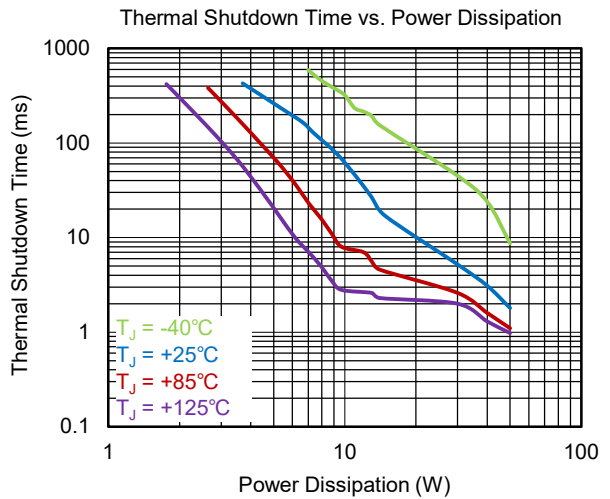
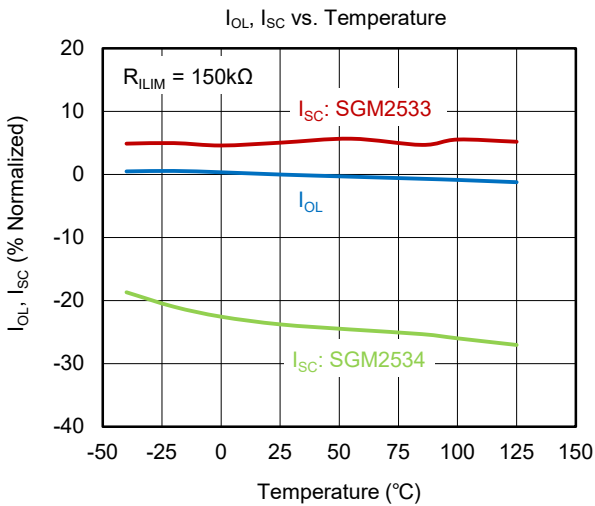
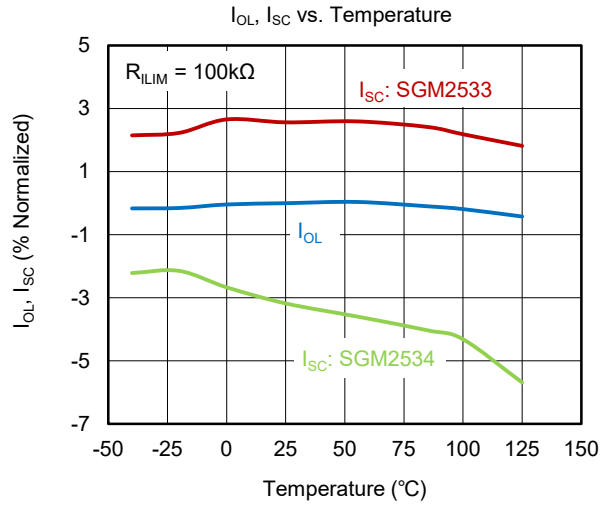
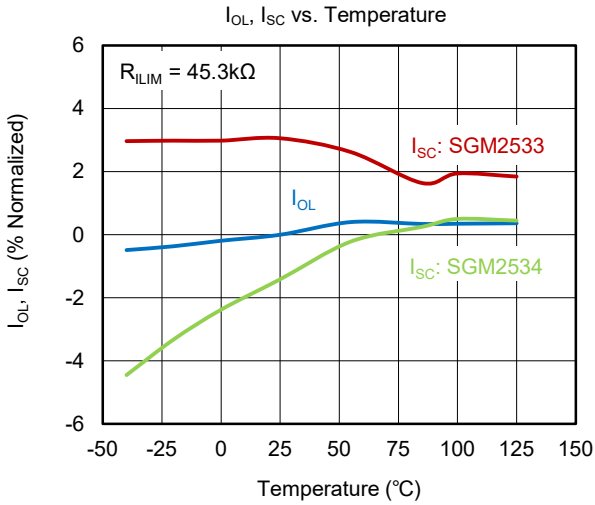

**TYPICAL PERFORMANCE CHARACTERISTICS (continued)**

$T_J = +25^\circ\text{C}$ ,  $V_{IN} = 5\text{V}$  for SGM2533,  $V_{IN} = 12\text{V}$  for SGM2534,  $V_{EN/UVLO} = 2\text{V}$ ,  $R_{LIM} = 100\text{k}\Omega$ ,  $C_{SS} = \text{Open}$ ,  $C_{IN} = 0.1\mu\text{F}$ ,  $C_{OUT} = 1\mu\text{F}$ , unless otherwise noted.

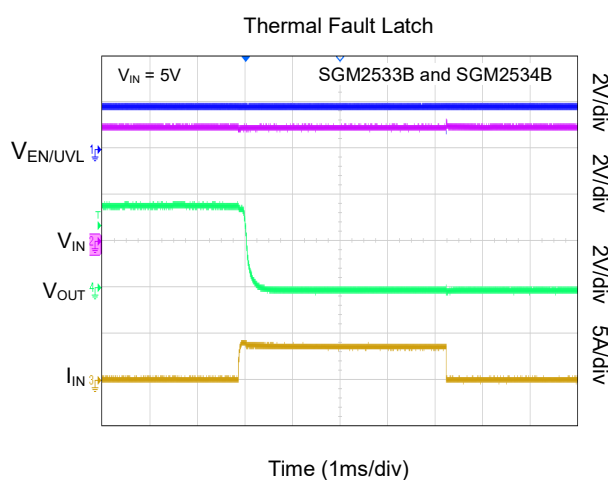
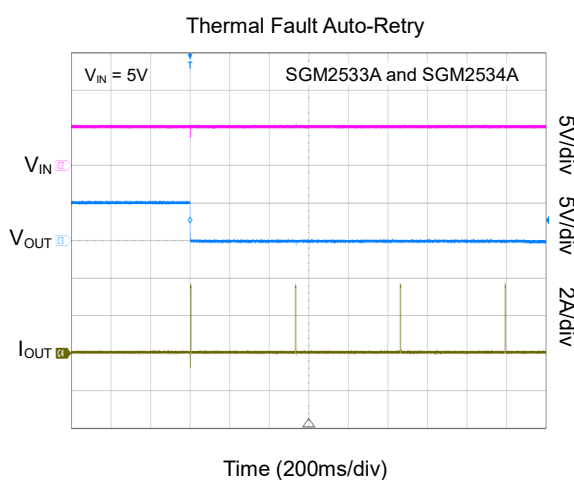
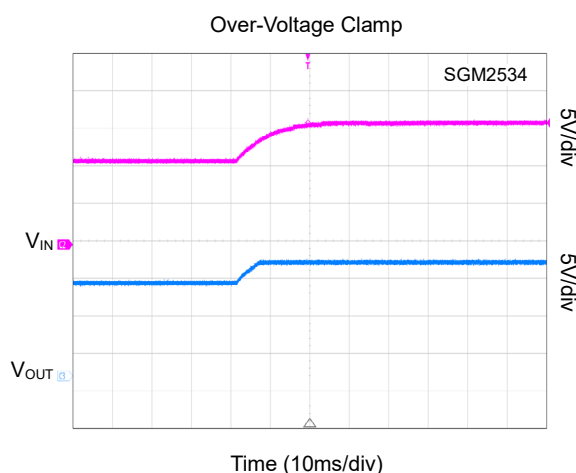
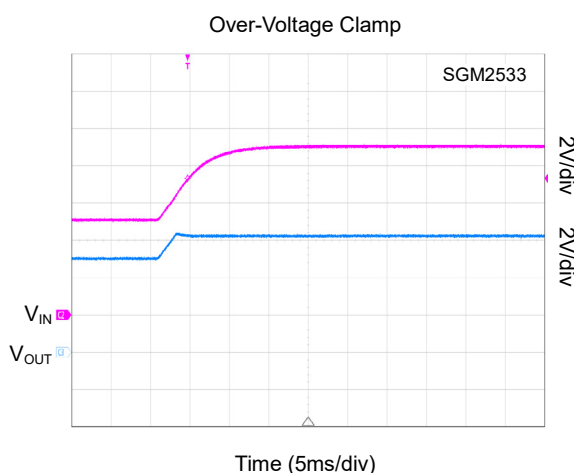
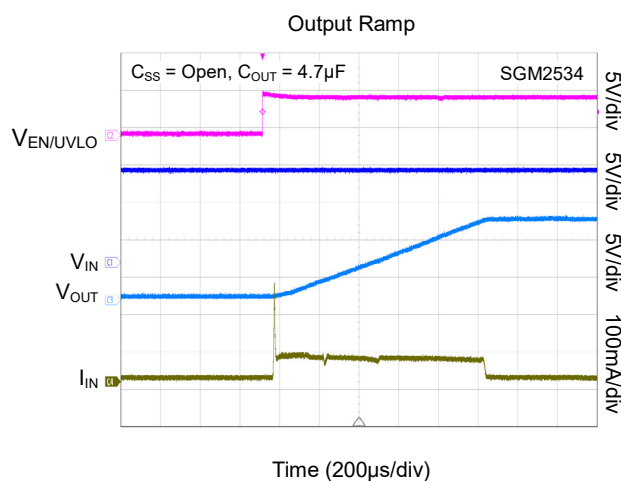
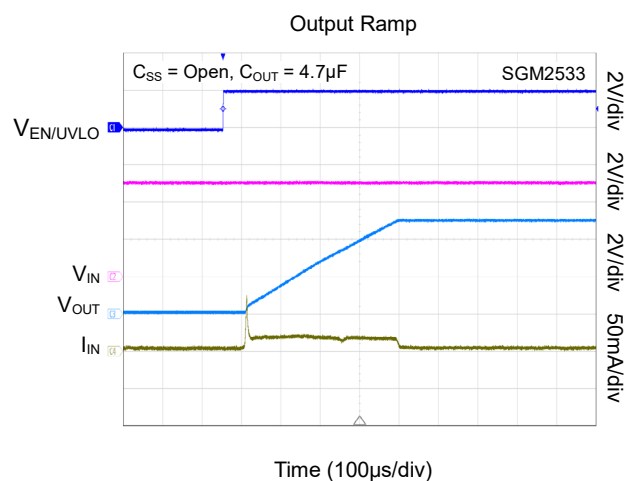

**TYPICAL PERFORMANCE CHARACTERISTICS (continued)**

$T_J = +25^\circ\text{C}$ ,  $V_{IN} = 5\text{V}$  for SGM2533,  $V_{IN} = 12\text{V}$  for SGM2534,  $V_{EN/UVLO} = 2\text{V}$ ,  $R_{LIM} = 100\text{k}\Omega$ ,  $C_{SS} = \text{Open}$ ,  $C_{IN} = 0.1\mu\text{F}$ ,  $C_{OUT} = 1\mu\text{F}$ , unless otherwise noted.

Output Short-Circuit

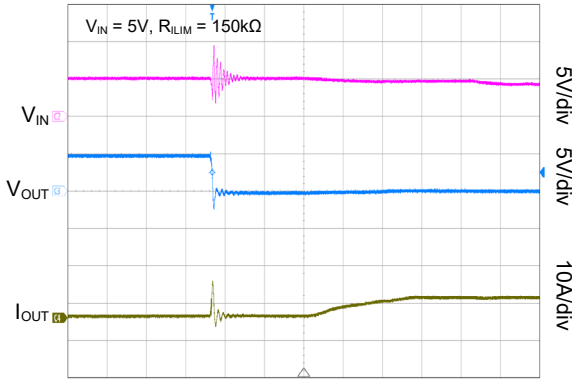

Time (20µs/div)

Short-Circuit (Zoom): Fast-Trip Comparator

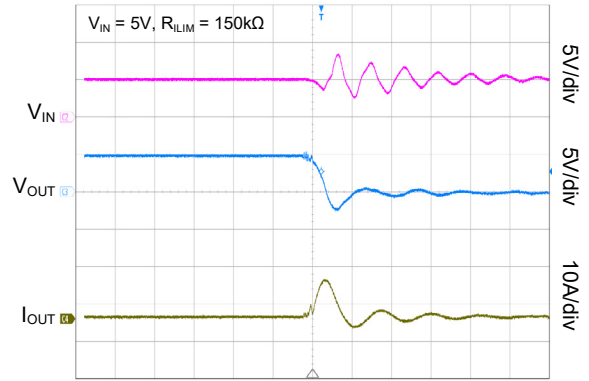

Time (2µs/div)

Wake Up to Short-Circuit

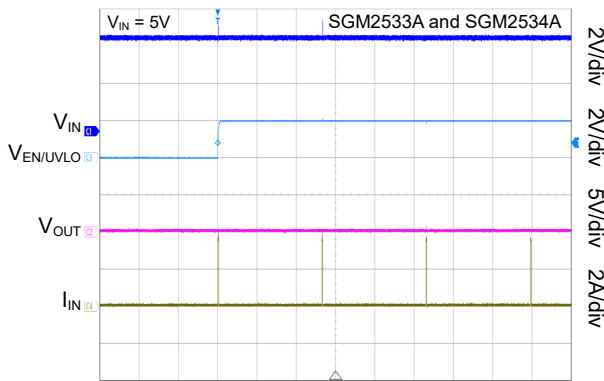

Time (200ms/div)

Recovery from Short-Circuit

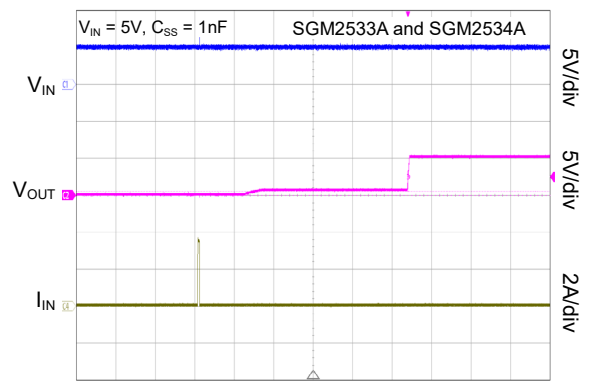

Time (100ms/div)

Output Short-Circuit

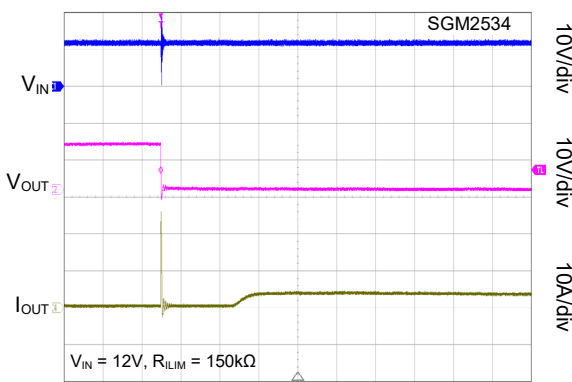

Time (50µs/div)

Short-Circuit (Zoom): Fast-Trip Comparator

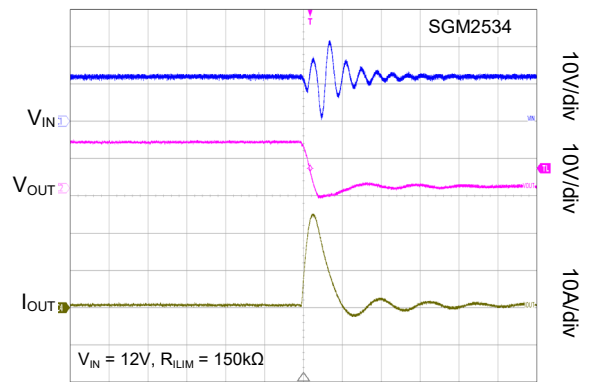

Time (2µs/div)

**TYPICAL PERFORMANCE CHARACTERISTICS (continued)**

$T_J = +25^\circ\text{C}$ ,  $V_{IN} = 5\text{V}$  for SGM2533,  $V_{IN} = 12\text{V}$  for SGM2534,  $V_{EN/UVLO} = 2\text{V}$ ,  $R_{LIM} = 100\text{k}\Omega$ ,  $C_{SS} = \text{Open}$ ,  $C_{IN} = 0.1\mu\text{F}$ ,  $C_{OUT} = 1\mu\text{F}$ , unless otherwise noted.

Wake Up to Short-Circuit

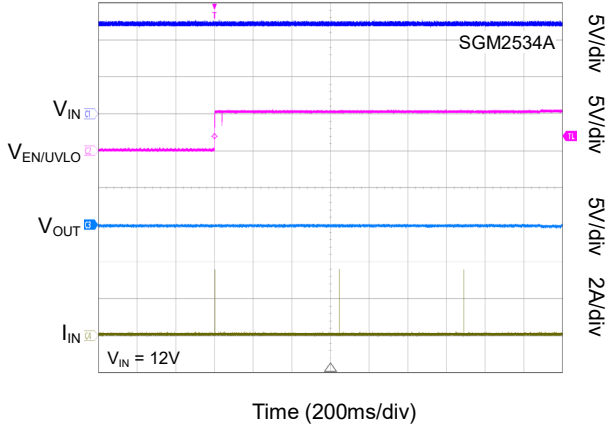

Recovery from Short-Circuit

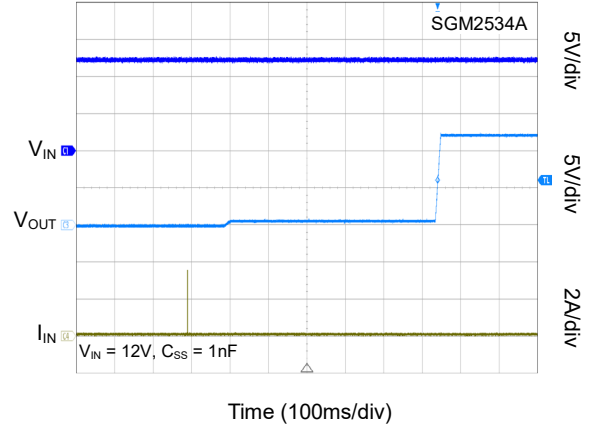

Thermal Fault Auto-Retry

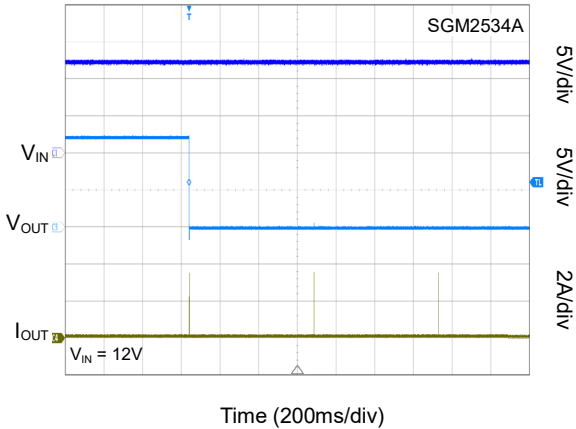

Overload Current Limit

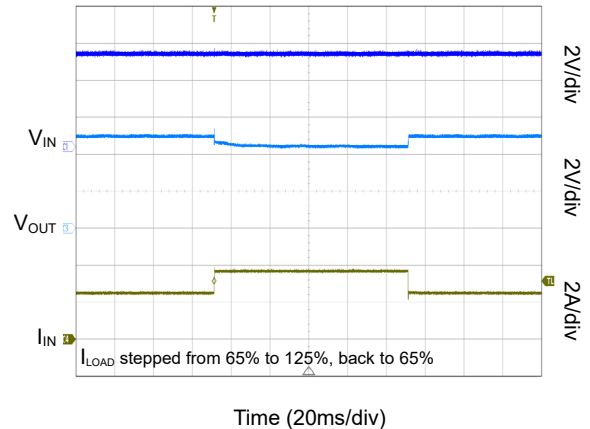

Hot-Plug Startup: Output Ramp without Load on Output

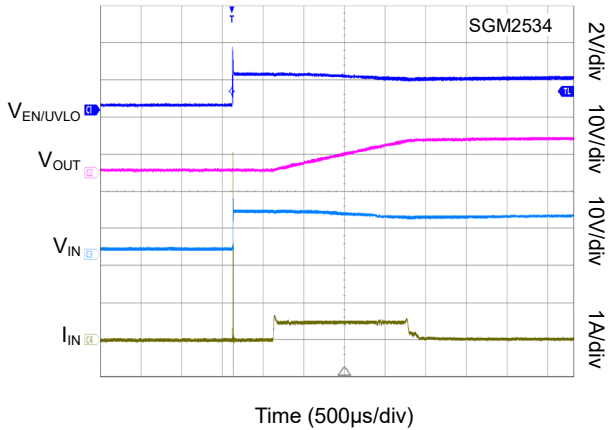

Hot-Plug Startup: Output Ramp with 24Ω Load at Startup

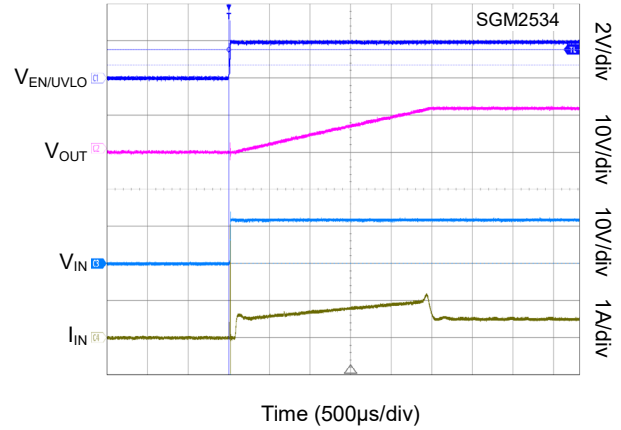

**DETAILED DESCRIPTION**

**Overview**

The SGM2533 and SGM2534 are intelligent eFuses with enhanced built-in protection circuitry. It integrates over-current and short-circuit protections. Precision current limit helps to minimize over-design of the input power supply, while fast response short-circuit protection isolates the load from the input immediately when a short-circuit condition is detected. The device allows the user to program the over-current limit threshold between 2A and 5A via an external resistor.

The over-voltage clamp (OVC) function continuously monitors the input voltage and ensures the output clamp voltage to  $V_{OVC}$  level once the input spike voltage occurs. This can protect the safety of output device, and continuous output clamping condition usually results in thermal shutdown. Once the junction temperature exceeds 155°C, the power MOSFET will be turned off by the thermal shutdown circuitry. For SGM2533B and SGM2534B, if the power supply or EN/UVLO is reset (pulled low and then pulled up), the device tries to turn on the power MOSFET again. For SGM2533A and SGM2534A, the device is designed a 490ms auto-retry cycle after device temperature drops to 135°C. Unless the fault is removed, the auto-retry cycle will be continued.

**EN/UVLO**

The EN/UVLO is designed to control the device active and shutdown states. Logic high (exceed  $V_{ENR}$ ) enables the device and it turns on the internal power MOSFET and controls the current from IN to the OUT. Once the input signal under the  $V_{ENF}$ , it turns off the power MOSFET. The thermal shutdown latch in SGM2533B and SGM2534B can be cleared by the EN/UVLO that toggling this pin (H→L) will restart the device. It is recommended to add an external bypass capacitor between EN/UVLO and GND pins to avoid the noisy of instability power or probabilistic power failure. The EN/UVLO falling edge de-glitch delay is 1μs (TYP).

**IN**

The IN pin should be connected to the power source directly. It is recommended to place a ceramic bypass capacitor close the device to reduce bus transient. The input voltage of devices can be sustained up to 20V, the recommend input voltage range of SGM2534 is 4.5V to 13.8V, and SGM2533 is 4.5V to 5.5V. The device will enter into over-voltage protection (OVP) mode, if the input voltage exceeds the maximum recommended operation condition. The device may heat up due to power dissipation, and then enter into the thermal shutdown state.

**SS**

The capacitor between SS and GND pins will set the slew rate according to the application requirements. If floating this pin, the slew rate of the output obtains a default value (minimum  $t_{SS}$ ). Equation 1 shows the calculation process.

$$\frac{dV_{OUT}}{dt} = \frac{I_{SS} \times GAIN_{SS}}{C_{SS}} \tag{1}$$

where:

$dV_{OUT}/dt$  = Desired output slew rate

$I_{SS}$  = 223nA (TYP)

$GAIN_{SS}$  = 4.84

Equation 2 shows how to calculate the total ramp time ( $t_{SS}$ ) when the output rises from 0V to  $V_{IN}$ :

$$t_{SS} = 0.9 \times 10^6 \times V_{IN} \times C_{SS} \tag{2}$$

When  $C_{SS}$  is open, there is a 70pF capacitor ( $C_{INT}$ ) inside.

**DETAILED DESCRIPTION (continued)**

**ILIM**

At all times, load current is monitored by directly sensing the current flowing through the internal MOSFET. During overload events, current is limited to the overload current limit ( $I_{OL}$ ) programmed by  $R_{ILIM}$ .

$$I_{OL} = (0.8 + 3 \times 10^{-5} \times R_{ILIM}) \quad (3)$$

Power dissipation of the internal MOSFET is calculated by  $P_D = (V_{IN} - V_{OUT}) \times I_{OUT}$ . If it is set to constant 40W, the continue overload state will cause thermal shutdown.

A transient short-circuit is happened, due to the limited bandwidth of the current limit amplifier, it can not respond quickly to this event, so the SGM2533 and SGM2534 contain a fast-trip comparator with a threshold ( $I_{FAST-TRIP}$ ). If  $I_{OUT} > I_{FAST-TRIP}$ , the comparator turns off the power MOSFET and terminates the short-circuit peak current cross the power MOSFET rapidly. The fast-trip threshold is 1.6 times of the overload current limit. The fast-trip comparator can terminate the transient short-circuit peak current, and then the current limit function limits the output current to  $I_{OL}$ .

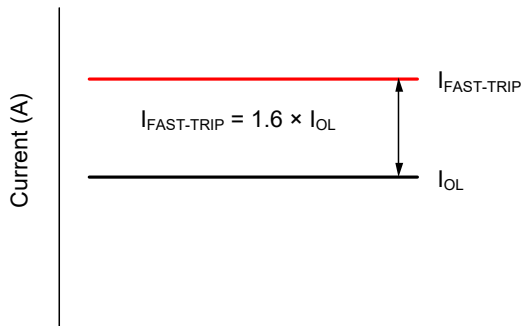

**Figure 3. Fast-Trip Current**

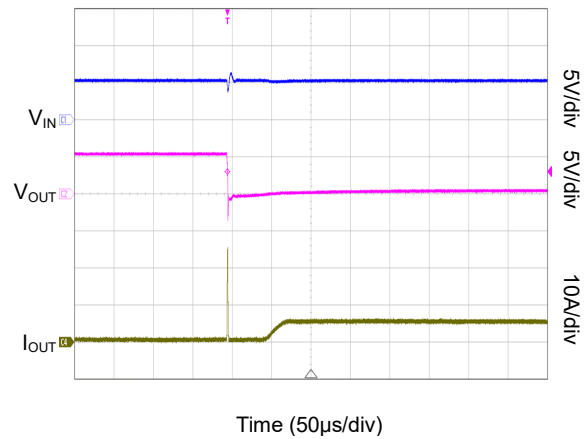

**Figure 4. Fast-Trip and Current Limit Amplifier Response for Short-Circuit**

**APPLICATION INFORMATION**

**Typical Application Circuit**

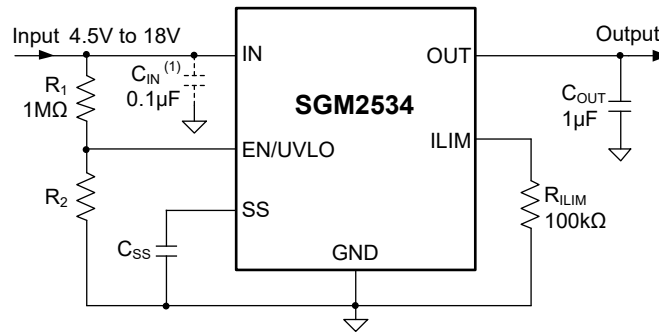

NOTE: 1. A 0.1μF CIN is recommended. It is optional.

**Figure 5. Simple eFuse for Set-Top Boxes**

**Design Requirements**

Table 1 lists the typical application circuit requirements of SGM2534.

**Table 1. Design Parameters**

Design Parameter	Example Value
Input Voltage, VIN	12V
Under-Voltage Lockout Set Point, VUV	Default: VUVR = 4.3V
Over-Voltage Protection Set Point, VOV	Default: VOVC = 14.86V
Load at Startup, RL(SU)	4Ω
Current Limit, IOL	3.8A
Load Capacitance, COUT	1μF
Maximum Junction Temperature, TJ	+125°C

**Input Capacitor**

It is recommended to use a capacitor (0.001μF to 0.1μF) between IN and GND close to the device pins. It can limit the voltage drop on the input supply.

**Power Supply**

The power supply range is 4.5V to 13.8V for SGM2534. If the distance between the power supply and the device is more than a few inches, it is recommended to use a higher than 0.1μF input bypass capacitor.

**Programmable Current Limit**

The overload current limit is programmed by the RILIM resistor with Equation 4.

$$R_{ILIM} = \frac{I_{OL} - 0.8}{3 \times 10^{-5}} \quad (4)$$

Assuming IOL = 3.8A, RILIM is calculated as 100kΩ, select the resistor with 1% tolerance closest to the standard value.

**Set Point for Under-Voltage Lockout**

Setting the external voltage divider of R1 and R2 will adjust the under-voltage lockout (UVLO) point of the device. The R1 and R2 resistors are placed between IN, EN/UVLO and GND pins. Equation 5 shows how to calculate these resistor values:

$$V_{UV} = \frac{R_1 + R_2}{R_2} \times V_{ENR} \quad (5)$$

VENR rises over the threshold (1.4V), the device is turned on.

If VIN is less than 7V, the EN/UVLO can be connected to VIN directly. When VIN is greater than 7V, EN/UVLO is the partial pressure of VIN.

The falling edge of power supply is set to detect for power failure, usually the threshold is 5% lower than the VUVR (the rising threshold). Equation 6 shows how it will be calculated:

$$V_{PF\ FAIL} = 0.95 \times V_{UVR} \quad (6)$$

where VUVR is 4.3V, power fail threshold is 4.09V.



**APPLICATION INFORMATION (continued)**

**Setting Output Ramp Time ( $t_{SS}$ )**

The SGM2534 is designed to control the inrush current when the device is enabled or powered-on. The slew rate of the output voltage can be set by an external capacitor from the SS pin to GND defines at power-on. The ramp-up capacitor ( $C_{SS}$ ) is calculated considering the two possible cases.

**Startup without Load: Only Charge the Output Capacitance  $C_{OUT}$**

Once the device startup, the current as load that charges the output capacitor. This process causes the inrush current, and it can be calculated by Equation 7. Combining the voltage difference and the load current, the power is dissipated across the internal MOSFET. Equation 8 shows how to calculate the average power dissipation during startup:

$$I_{INRUSH} = C_{OUT} \times \frac{V_{IN}}{t_{SS}} \quad (7)$$

$$P_{D(INRUSH)} = 0.5 \times V_{IN} \times I_{INRUSH} \quad (8)$$

**Startup with Load: Output Capacitance  $C_{OUT}$  and Load Draws Current**

During startup, the load ( $R_{L(SU)}$ ) current ramps up proportionally with the increase of output voltage. The average power dissipation in the internal MOSFET during charging time is shown in Equation 9 to Equation 12.

$$P_{D(LOAD)} = \left(\frac{1}{6}\right) \times \frac{V_{IN}^2}{R_{L(SU)}} \quad (9)$$

$$P_{D(STARTUP)} = P_{D(INRUSH)} + P_{D(LOAD)} \quad (10)$$

$$I_{STARTUP} = I_{INRUSH} + I_{LOAD} \quad (11)$$

where:

$P_{D(STARTUP)}$  is the total power dissipation during startup.

$I_{STARTUP}$  is total current during startup.

When  $I_{STARTUP} > I_{OL}$ , the device limits the current to  $I_{OL}$  and the current limit charging time is determined by:

$$t_{SS(Current\ Limit)} = C_{OUT} \times R_{L(SU)} \times \left[ \frac{I_{OL}}{I_{INRUSH}} - 1 + \ln \left( \frac{I_{INRUSH}}{I_{OL} - \frac{V_{IN}}{R_{L(SU)}}} \right) \right] \quad (12)$$

For the design example with  $C_{SS} = \text{open}$ :

$$t_{SS} = 0.9 \times 10^6 \times 12V \times 70pF = 756\mu s \quad (13)$$

$$I_{INRUSH} = 1\mu F \times \frac{12V}{756\mu s} = 15.9mA \quad (14)$$

$$P_{D(INRUSH)} = 0.5 \times 12V \times 15.9mA = 95.4mW \quad (15)$$

So it is safe to use 756 $\mu$ s as startup time without any load on output. Considering the startup with a 4 $\Omega$  load, the additional power dissipation is calculated using Equation 9.

$$P_{D(LOAD)} = \frac{12V \times 12V}{6 \times 4\Omega} = 6W \quad (16)$$

$$P_{D(STARTUP)} = 6W + 95.4mW = 6.10W \quad (17)$$

As shown in Figure 6, when  $T_J = +85^\circ C$ , the thermal shutdown time for 6.10W is higher than 10ms. In order to prevent the false shutdown at maximum operating temperature, the ramp time must be less than thermal shutdown time. So it is safe to select 756 $\mu$ s as startup time with startup load of 4 $\Omega$ .

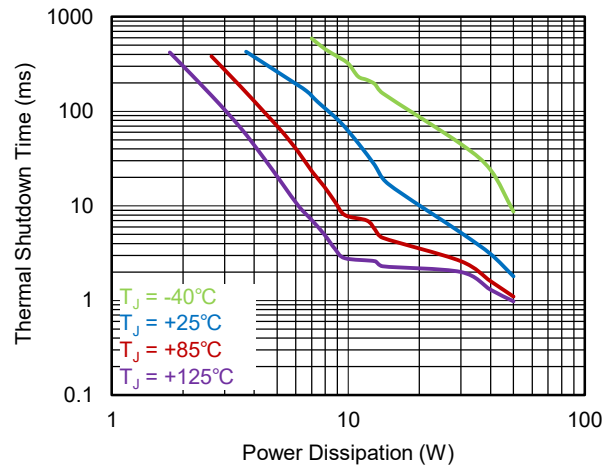

**Figure 6. Thermal Shutdown Limit Plot**

**APPLICATION INFORMATION (continued)**

**Transient Protection**

In case of turning off the internal MOSFET, such as  $V_{OUT}$  hard short, thermal shutdown, etc., the current flow path is cut off. The energy stored in parasitic inductance generates voltage spike. The input inductance produces a positive voltage spike on the input, while the output inductance produces a negative voltage spike on the output. The voltage spike can exceed the absolute maximum ratings of the device if the following steps are not taken:

- ◆ Minimizing lead length and inductance into and out of the device, including the GND connection.
- ◆ Schottky diode across the output to absorb negative spikes.
- ◆ A low value ceramic capacitor ( $C_{IN} = 0.001\mu F$  to  $0.1\mu F$ ) to absorb the energy. The approximate value of  $C_{IN}$  can be calculated with Equation 18.

$$V_{SPIKE(Absolute)} = V_{IN} + I_{LOAD} \times \sqrt{\frac{L_{IN}}{C_{IN}}} \quad (18)$$

where:

$V_{IN}$  is the supply voltage.

$I_{LOAD}$  is the load current.

$L_{IN}$  equals the effective inductance seen looking into the source.

$C_{IN}$  is the input capacitance.

Some applications may require the addition of a transient voltage suppressor (TVS) across the IN pin and GND to prevent transients from exceeding the absolute maximum ratings of the device.

Ceramic capacitors, TVS and Schottky diodes are optional protection components. Optional components

can be used to suppress transients as shown in Figure 7.

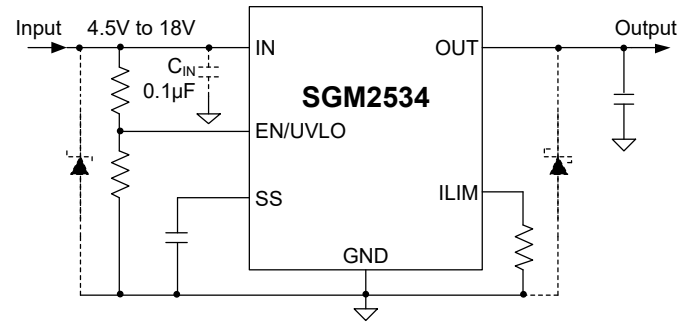

**Figure 7. Circuit Implementation with Optional Protection Components**

**Layout Guide**

- ◆ It is recommended to use a  $0.01\mu F$  or larger ceramic decoupling capacitor between IN and GND pins. When the input power path inductance is too low to ignore in hot plug applications, the capacitor can be minimized.
- ◆ The path of high current carrying power should be as short as possible, which is must size to withstand twice the load current.
- ◆ The GND pin must be connected to the PCB ground as short as possible.
- ◆ Connect the terminal of the  $R_{ILIM}$ ,  $C_{SS}$  and resistors for EN/UVLO to the GND pin with the shortest trace. These paths and switching signals should not have any coupling.
- ◆ The ceramic capacitors, TVS and Schottky diodes must be placed as close to the device as possible.

**REVISION HISTORY**

NOTE: Page numbers for previous revisions may differ from page numbers in the current version.

Changes from Original (FEBRUARY 2022) to REV.A	Page
Changed from product preview to production data.....	All

PACKAGE OUTLINE DIMENSIONS

TDFN-3x3-10L

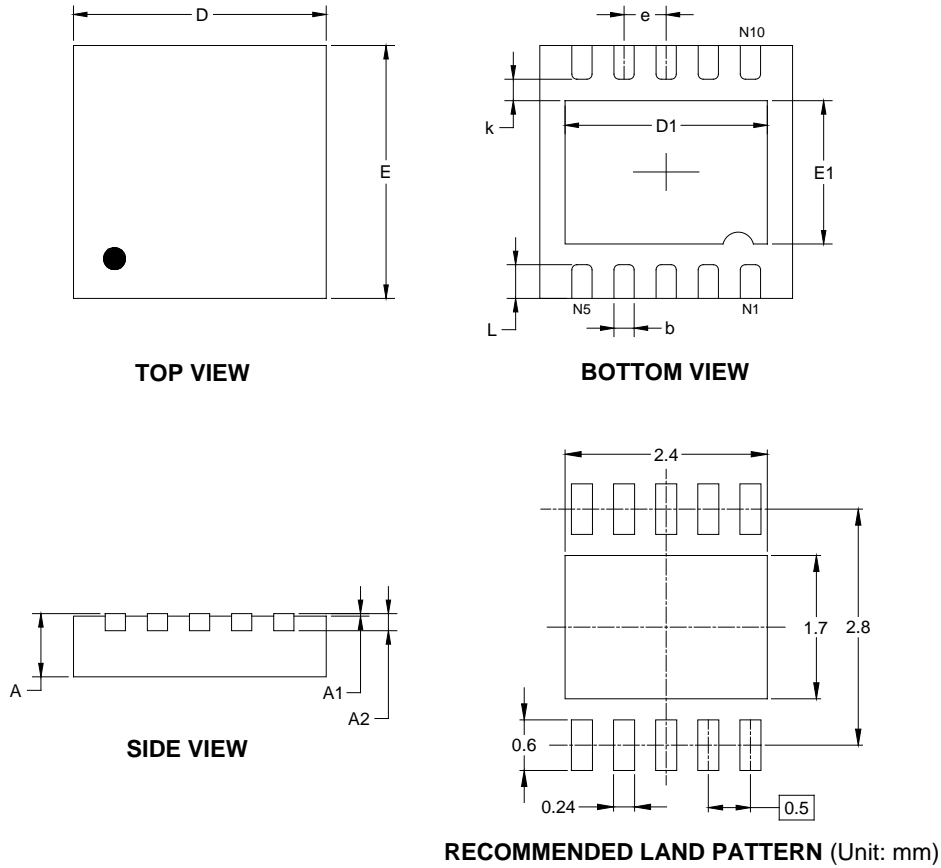

Symbol	Dimensions In Millimeters		Dimensions In Inches	
	MIN	MAX	MIN	MAX
A	0.700	0.800	0.028	0.031
A1	0.000	0.050	0.000	0.002
A2	0.203 REF		0.008 REF	
D	2.900	3.100	0.114	0.122
D1	2.300	2.600	0.091	0.103
E	2.900	3.100	0.114	0.122
E1	1.500	1.800	0.059	0.071
k	0.200 MIN		0.008 MIN	
b	0.180	0.300	0.007	0.012
e	0.500 TYP		0.020 TYP	
L	0.300	0.500	0.012	0.020

NOTE: This drawing is subject to change without notice.

# PACKAGE INFORMATION

## TAPE AND REEL INFORMATION

### REEL DIMENSIONS



### TAPE DIMENSIONS



NOTE: The picture is only for reference. Please make the object as the standard.

### KEY PARAMETER LIST OF TAPE AND REEL

Package Type	Reel Diameter	Reel Width W1 (mm)	A0 (mm)	B0 (mm)	K0 (mm)	P0 (mm)	P1 (mm)	P2 (mm)	W (mm)	Pin1 Quadrant
TDFN-3×3-10L	13"	12.4	3.35	3.35	1.13	4.0	8.0	2.0	12.0	Q1

000001

# PACKAGE INFORMATION

## CARTON BOX DIMENSIONS



NOTE: The picture is only for reference. Please make the object as the standard.

## KEY PARAMETER LIST OF CARTON BOX

Reel Type	Length (mm)	Width (mm)	Height (mm)	Pizza/Carton
13"	386	280	370	5

DD0002