

GENERAL DESCRIPTION

The SGM3846 is designed to drive AMOLED displays (Active Matrix Organic Light Emitting Diode) requiring V_{AVDD} , V_{ELVDD} and V_{ELVSS} . The device integrates a boost converter for V_{ELVDD} , an inverting buck-boost converter for V_{ELVSS} and a boost converter for V_{AVDD} , which are suitable for battery operated products. The digital interface control pin (CTRL) allows programming V_{AVDD} , V_{ELVDD} and V_{ELVSS} in digital steps.

The SGM3846 is available in Green TQFN-3x3-16L package. It operates over an ambient temperature range of -40°C to +85°C.

FEATURES

- 2.9V to 4.5V Input Voltage Range
- Synchronous Boost Converter (AVDD)
 - ◆ 5.8V to 7.9V Output Voltage (Programmable)
 - ◆ 6.1V Default Output Voltage
 - ◆ 1.2% Accuracy
 - ◆ 100mA Output Current Capability
 - ◆ V_{IN} to V_{OUT} and V_{OUT} to V_{IN} Isolation
- Synchronous Boost Converter (ELVDD)
 - ◆ 4.6V to 5.0V Output Voltage (Programmable)
 - ◆ 4.6V Default Output Voltage

- ◆ 1.2% Accuracy
- ◆ 400mA Output Current Capability
- ◆ External Output Voltage Sensing Pin for Load Drop Compensation
- ◆ V_{IN} to V_{OUT} and V_{OUT} to V_{IN} Isolation
- Synchronous Inverting Buck-Boost Converter (ELVSS)
 - ◆ -5.4V to -1.4V Output Voltage (Programmable)
 - ◆ -2.5V Default Output Voltage
 - ◆ 1.6% Accuracy at -2.5V ($\pm 40mV$)
 - ◆ 400mA Output Current Capability
 - ◆ V_{IN} to V_{OUT} and V_{OUT} to V_{IN} Isolation
- Short Circuit Protection
- Thermal Shutdown
- V_{ELVSS} Start-Up Delay: 10ms
- Short Circuit and OLP Detect Time: 1ms
- Available in Green TQFN-3x3-16L Package

APPLICATIONS

Smartphones
 Small Size Tablets
 Active Matrix OLED Displays $\leq 8''$

TYPICAL APPLICATION

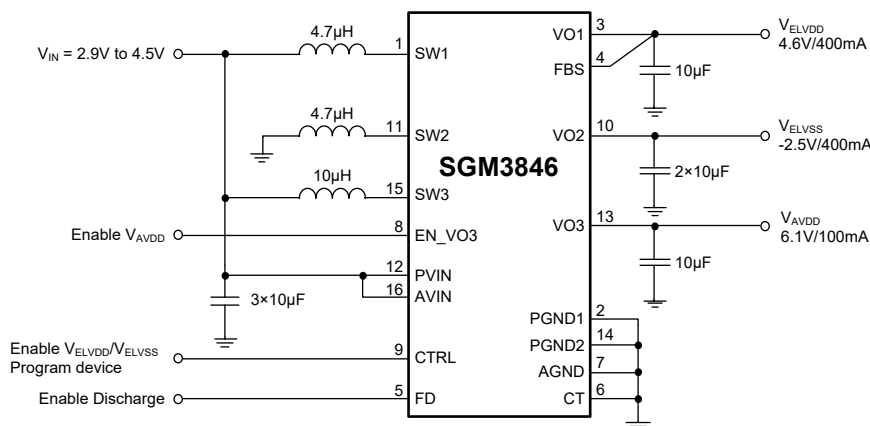

Figure 1. Typical Application Circuit

PACKAGE/ORDERING INFORMATION

MODEL	PACKAGE DESCRIPTION	SPECIFIED TEMPERATURE RANGE	ORDERING NUMBER	PACKAGE MARKING	PACKING OPTION
SGM3846	TQFN-3×3-16L	-40°C to +85°C	SGM3846YTQ16G/TR	3846TQ XXXXX	Tape and Reel, 4000

MARKING INFORMATION

NOTE: XXXXX = Date Code and Vendor Code.

XXXXX

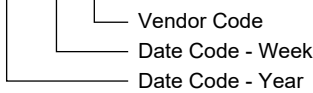

Green (RoHS & HSF): SG Micro Corp defines "Green" to mean Pb-Free (RoHS compatible) and free of halogen substances. If you have additional comments or questions, please contact your SGMICRO representative directly.

ABSOLUTE MAXIMUM RATINGS

- PVIN, AVIN, EN_VO3, CTRL, CT, FD, SW1, VO1, FBS Voltages ⁽¹⁾ -0.3V to 6V
- SW3, VO3 Voltages ⁽¹⁾ -0.3V to 10V
- VO2 Voltage ⁽¹⁾ -6.5V to 0.3V
- SW2 Voltage ⁽¹⁾ -6.5V to 5.5V
- Package Thermal Resistance
- TQFN-3×3-16L, θ_{JA} 45°C/W
- Junction Temperature +150°C
- Storage Temperature Range -65°C to +150°C
- Lead Temperature (Soldering, 10s) +260°C
- ESD Susceptibility
- HBM 4000V
- MM 400V
- CDM 1000V

RECOMMENDED OPERATING CONDITIONS

- Operating Ambient Temperature Range -40°C to +85°C
- Operating Junction Temperature Range -40°C to +125°C

NOTE:

1. All voltages are with respect to network ground pin.

OVERSTRESS CAUTION

Stresses beyond those listed in Absolute Maximum Ratings may cause permanent damage to the device. Exposure to absolute maximum rating conditions for extended periods may affect reliability. Functional operation of the device at any conditions beyond those indicated in the Recommended Operating Conditions section is not implied.

ESD SENSITIVITY CAUTION

This integrated circuit can be damaged by ESD if you don't pay attention to ESD protection. SGMICRO recommends that all integrated circuits be handled with appropriate precautions. Failure to observe proper handling and installation procedures can cause damage. ESD damage can range from subtle performance degradation to complete device failure. Precision integrated circuits may be more susceptible to damage because very small parametric changes could cause the device not to meet its published specifications.

DISCLAIMER

SG Micro Corp reserves the right to make any change in circuit design, or specifications without prior notice.

PIN CONFIGURATION

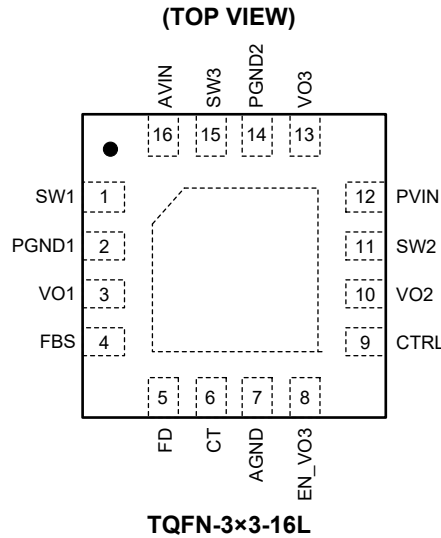

PIN DESCRIPTION

PIN	NAME	TYPE	DESCRIPTION
1	SW1	O	Switch Pin of the ELVDD Boost Converter.
2	PGND1	—	Power Ground of the ELVDD Boost Converter.
3	VO1	O	Output of the ELVDD Boost Converter.
4	FBS	I	ELVDD Sense Input.
5	FD	I	Active Discharge Enable/Disable During Shutdown.
6	CT	I/O	Control of the ELVSS Transition Time.
7	AGND	—	Analog Ground.
8	EN_VO3	I	Enable AVDD Boost Converter.
9	CTRL	I	Enable ELVDD Boost Converter and Delayed ELVSS Inverting Buck-Boost Converter. Digital programming.
10	VO2	O	Output of the ELVSS Inverting Buck-Boost Converter.
11	SW2	O	Switch Pin of the ELVSS Inverting Buck-Boost Converter.
12	PVIN	—	Supply for ELVSS Inverting Buck-Boost Converter.
13	VO3	O	Output of the AVDD Boost Converter.
14	PGND2	—	Power Ground of the AVDD Boost Converter.
15	SW3	O	Switch Pin of the AVDD Boost Converter.
16	AVIN	—	Supply for the Internal Analog Circuits.
Exposed Pad		—	Connect this pad to AGND, PGND1 and PGND2.

NOTE: I: input; O: output; I/O: input or output.

ELECTRICAL CHARACTERISTICS

(At $T_A = +25^\circ\text{C}$, $V_{IN} = 3.7\text{V}$, $V_{CTRL} = V_{EN_VO3} = V_{IN}$, $V_{ELVDD} = 4.6\text{V}$, $V_{ELVSS} = -2.5\text{V}$, $V_{AVDD} = 6.1\text{V}$, Full = -40°C to $+85^\circ\text{C}$, unless otherwise noted.)

PARAMETER	SYMBOL	CONDITIONS	TEMP	MIN	TYP	MAX	UNITS
SUPPLY CURRENT AND THERMAL PROTECTION							
Input Voltage Range	V_{IN}		Full	2.9		4.5	V
Shutdown Current into V_{IN}	I_{SD}	$V_{CTRL} = V_{EN_VO3} = \text{GND}$, $V_{FD} = \text{GND}$ or $V_{FD} = 3.7\text{V}$	$+25^\circ\text{C}$		0.1	1	μA
Under-Voltage Lockout Threshold (AVIN)	V_{IT-}	V_{IN} falling	$+25^\circ\text{C}$	2.35			V
	V_{IT+}	V_{IN} rising	$+25^\circ\text{C}$			2.8	V
Thermal Shutdown Temperature		Junction temperature rising			135		$^\circ\text{C}$
Thermal Shutdown Hysteresis		Junction temperature falling			10		$^\circ\text{C}$
LOGIC SIGNALS (EN_VO3, CTRL, FD)							
Logic High Level Voltage	V_H	$V_{IN} = 2.9\text{V}$ to 4.5V	Full	1.2			V
Logic Low Level Voltage	V_L	$V_{IN} = 2.9\text{V}$ to 4.5V	Full			0.4	V
Pull-Down Resistor (EN_VO3, CTRL)	R_{DOWN}		$+25^\circ\text{C}$	350	550	750	k Ω
BOOST CONVERTER ($V_{VO1} = V_{ELVDD}$)							
Positive Output 1 Voltage	V_{VO1}		$+25^\circ\text{C}$	4.6	4.6	5.0	V
Positive Output 1 Voltage Variation		$V_{VO1} = 4.6\text{V}$, no load	$+25^\circ\text{C}$	-1.2		1.2	%
			Full	-1.5		1.5	
SW1 MOSFET On-Resistance	$R_{DS(ON)1}$	$I_{DS} = 100\text{mA}$	$+25^\circ\text{C}$		170		m Ω
SW1 MOSFET Rectifier On-Resistance	$R_{DS(ON)2}$	$I_{DS} = 100\text{mA}$	$+25^\circ\text{C}$		300		
SW1 Switch Current Limit	I_{SW1}	Inductor valley current	$+25^\circ\text{C}$	0.75	1	1.4	A
SW1 Switching Frequency	f_{SW1}	$I_{VO1} = 100\text{mA}$	$+25^\circ\text{C}$	1.3	1.5	1.75	MHz
Short Circuit Threshold in Operation	$V_{VO1(SCP)}$	Percentage of nominal V_{VO1}	$+25^\circ\text{C}$		90		%
Threshold of Output Sense with VO1	V_{TVO1}	$V_{VO1} - V_{FBS}$ increasing	$+25^\circ\text{C}$		300		mV
Threshold of Output Sense with FBS	V_{TFBS}	$V_{VO1} - V_{FBS}$ decreasing	$+25^\circ\text{C}$		200		mV
VO1 and FBS Leakage, No Discharge	I_{LEAK_VO1}	$V_{FD} = \text{GND}$, $V_{CTRL} = \text{GND}$	$+25^\circ\text{C}$		0.8	2	μA
Pull-Down Resistance of FBS	R_{FBS}		$+25^\circ\text{C}$		4		M Ω
VO1 Discharge Resistance	$R_{VO1(DCG)}$	$V_{CTRL} = \text{GND}$, $I_{VO1} = 1\text{mA}$	$+25^\circ\text{C}$		30		Ω
Line Regulation		$I_{VO1} = 100\text{mA}$, $V_{IN} = 2.9\text{V}$ to 4.5V	$+25^\circ\text{C}$		0.007		%/V
Load Regulation		$1\text{mA} \leq I_{VO1} \leq 400\text{mA}$	$+25^\circ\text{C}$		0.27		%/A
BUCK-BOOST CONVERTER ($V_{VO2} = V_{ELVSS}$)							
Negative Output Voltage Range	V_{VO2}		$+25^\circ\text{C}$	-5.4	-2.5	-1.4	V
Negative Output Voltage Regulation		$V_{VO2} = -2.5\text{V}$, no load	$+25^\circ\text{C}$	-40		40	mV
			Full	-50		50	
SW2 MOSFET On-Resistance	$R_{DS(ON)3}$	$I_{DS} = 100\text{mA}$	$+25^\circ\text{C}$		260		m Ω
SW2 MOSFET Rectifier On-Resistance	$R_{DS(ON)4}$	$I_{DS} = 100\text{mA}$	$+25^\circ\text{C}$		250		
SW2 Switch Current Limit	I_{SW2}	Inductor peak current	$+25^\circ\text{C}$	1.6	1.85	2.1	A
SW2 Switching Frequency	f_{SW2}	$I_{VO2} = 100\text{mA}$	$+25^\circ\text{C}$	1.3	1.5	1.75	MHz
Short Circuit Threshold in Operation	$V_{VO2(SCP)}$	Voltage rise from nominal V_{VO2}	$+25^\circ\text{C}$		500		mV
VO2 Negative Comparator at Start-Up			$+25^\circ\text{C}$		-700		
VO2 Leakage, No Discharge	I_{LEAK_VO2}	$V_{FD} = V_{CTRL} = \text{GND}$	$+25^\circ\text{C}$		0.1	1	μA
VO2 Discharge Resistance	$R_{VO2(DCG)}$	$V_{CTRL} = \text{GND}$, $I_{VO2} = 1\text{mA}$	$+25^\circ\text{C}$		150		Ω
CT Pin Output Impedance	R_{CT}		$+25^\circ\text{C}$		300		k Ω
CT Pin Comparator	Comp _{CT}	V_{CT} rising	$+25^\circ\text{C}$		50		mV

ELECTRICAL CHARACTERISTICS (continued)

(At $T_A = +25^\circ\text{C}$, $V_{IN} = 3.7\text{V}$, $V_{CTRL} = V_{EN_VO3} = V_{IN}$, $V_{ELVDD} = 4.6\text{V}$, $V_{ELVSS} = -2.5\text{V}$, $V_{AVDD} = 6.1\text{V}$, Full = -40°C to $+85^\circ\text{C}$, unless otherwise noted.)

PARAMETER	SYMBOL	CONDITIONS	TEMP	MIN	TYP	MAX	UNITS
Line Regulation		$I_{VO2} = 100\text{mA}$, $V_{IN} = 2.9\text{V}$ to 4.5V	$+25^\circ\text{C}$		0.003		%/V
Load Regulation		$1\text{mA} \leq I_{VO2} \leq 400\text{mA}$	$+25^\circ\text{C}$		0.37		%/A
BOOST CONVERTER ($V_{VO3} = V_{AVDD}$)							
Positive Output 2 Voltage Range	V_{VO3}		$+25^\circ\text{C}$	5.8	6.1	7.9	V
Positive Output 2 Voltage Regulation		$V_{VO3} = 6.1\text{V}$, no load	$+25^\circ\text{C}$	-1.2		1.2	%
			Full	-1.4		1.4	
SW3 MOSFET On-Resistance	$R_{DS(ON)5}$	$I_{DS} = 100\text{mA}$	$+25^\circ\text{C}$		500		m Ω
SW3 MOSFET Rectifier On-Resistance	$R_{DS(ON)6}$	$I_{DS} = 100\text{mA}$	$+25^\circ\text{C}$		900		
SW3 Switch Current Limit	I_{SW3}	Inductor peak current	$+25^\circ\text{C}$	0.25	0.35	0.5	A
SW3 Switching Frequency	f_{SW3}	$I_{VO3} = 30\text{mA}$	$+25^\circ\text{C}$	1.3	1.5	1.75	MHz
Output Current Sensing	I_{OUT}		$+25^\circ\text{C}$		120		mA
Short Circuit Threshold in Operation	$V_{VO3(SCP)}$	Percentage of nominal V_{VO3}	$+25^\circ\text{C}$		90		%
VO3 Leakage, No Discharge	I_{LEAK_VO3}	$V_{FD} = \text{GND}$, $V_{EN_VO3} = \text{GND}$	$+25^\circ\text{C}$		2	3	μA
VO3 Discharge Resistance	$R_{VO3(DCG)}$	$V_{EN_VO3} = \text{GND}$, $I_{VO3} = 1\text{mA}$	$+25^\circ\text{C}$		30		Ω
Line Regulation		$I_{VO3} = 30\text{mA}$, $V_{IN} = 2.9\text{V}$ to 4.5V	$+25^\circ\text{C}$		0.013		%/V
Load Regulation		$1\text{mA} \leq I_{VO3} \leq 55\text{mA}$	$+25^\circ\text{C}$		0.4		%/A

TIMING REQUIREMENTS

PARAMETER	SYMBOL	MIN	TYP	MAX	UNITS
SHORT-CIRCUIT TIMER					
VO1 Short Circuit Detection Time in Start-Up	$t_{VO1(SCP)}$		10		ms
VO1 Short Circuit Detection Time in Operation			1		
VO2 Short Circuit Detection Time in Start-Up	$t_{VO2(SCP)}$		10		
VO2 Short Circuit Detection Time in Operation			1		
VO3 Short Circuit Detection Time in Operation	$t_{VO3(SCP)}$		1		
VO3 Overload Detection Delay	$t_{D(OVERLOAD)}$		1		
VO2 Discharge Time after CTRL Goes High	$t_{D(DISCHARGE)}$		10		
CTRL INTERFACE					
Initialization Time	t_{INIT}		300	400	μs
Shutdown Time Period	t_{OFF}	30	55	80	
Pulse High Level Time Period	t_{HIGH}	2	10	25	
Pulse Low Level Time Period	t_{LOW}	2	10	25	
Data Storage/Accept Time Period	t_{STORE}	30	55	80	

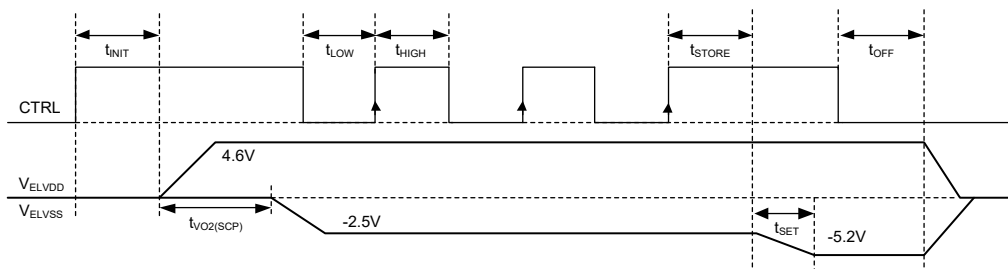
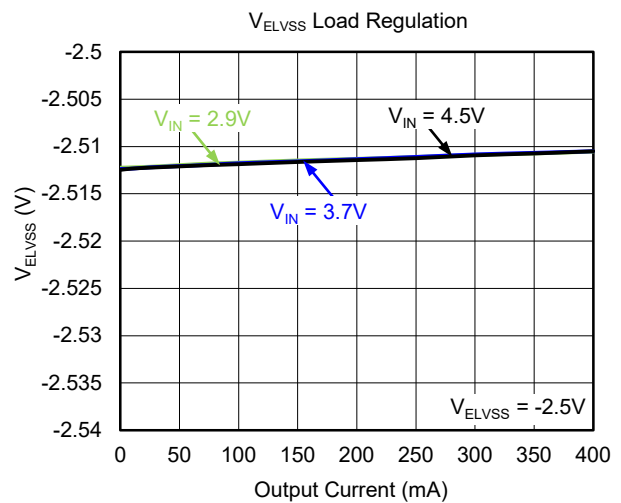
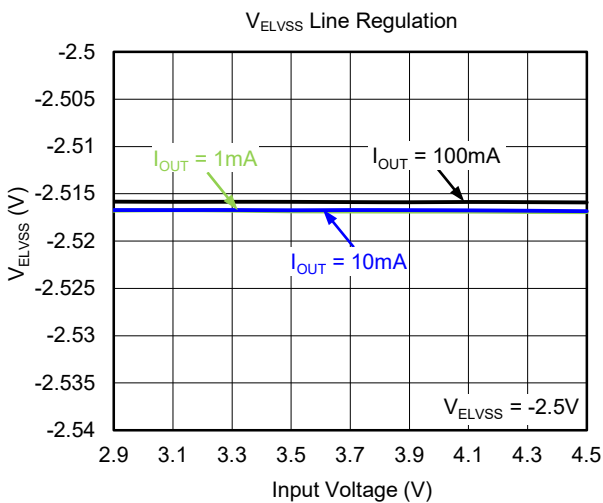
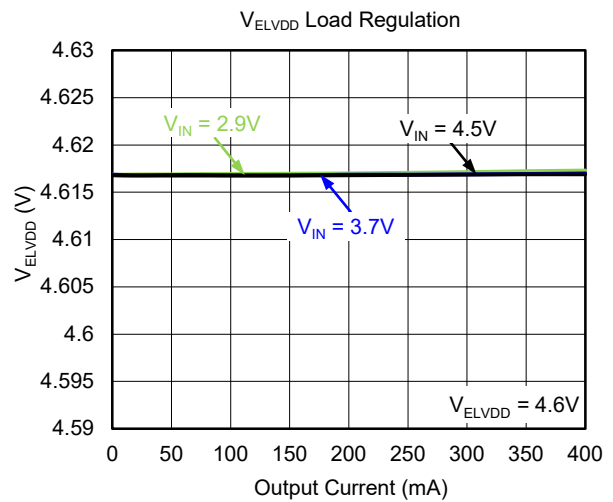
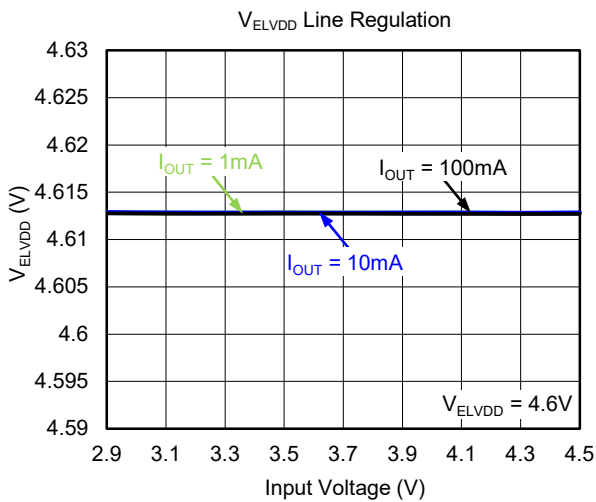
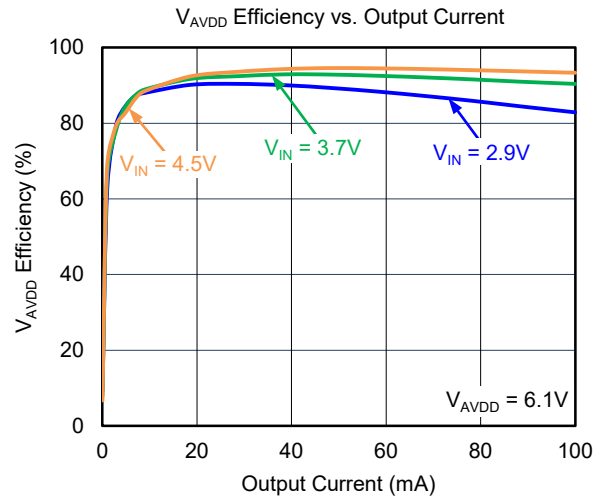
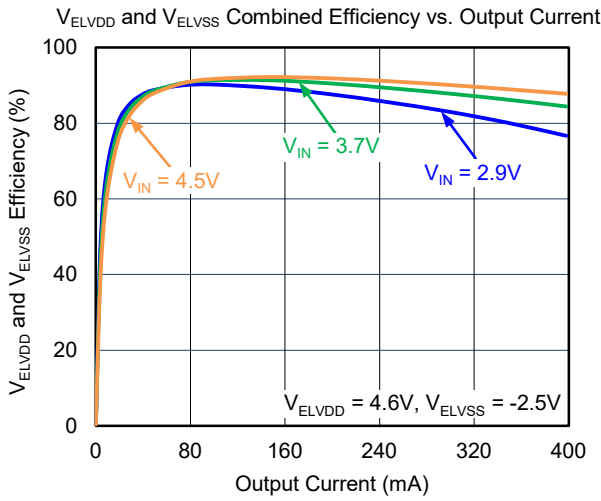

Figure 2. Timing Diagram

TYPICAL PERFORMANCE CHARACTERISTICS

At $T_A = +25^\circ\text{C}$, $V_{IN} = 3.7\text{V}$, unless otherwise noted.



TYPICAL PERFORMANCE CHARACTERISTICS (continued)

At $T_A = +25^\circ\text{C}$, $V_{IN} = 3.7\text{V}$, unless otherwise noted.

V_{AVDD} Line Regulation

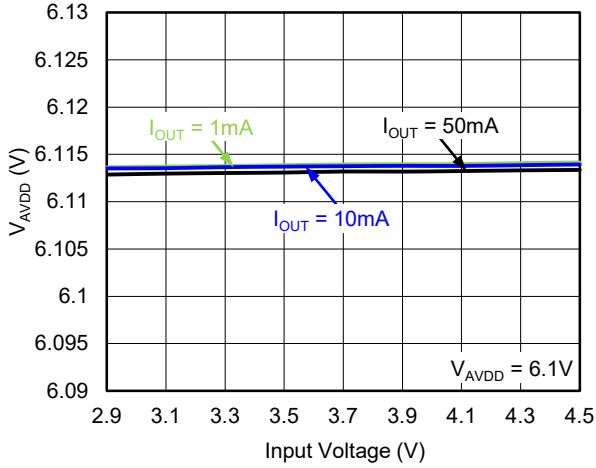

V_{AVDD} Load Regulation

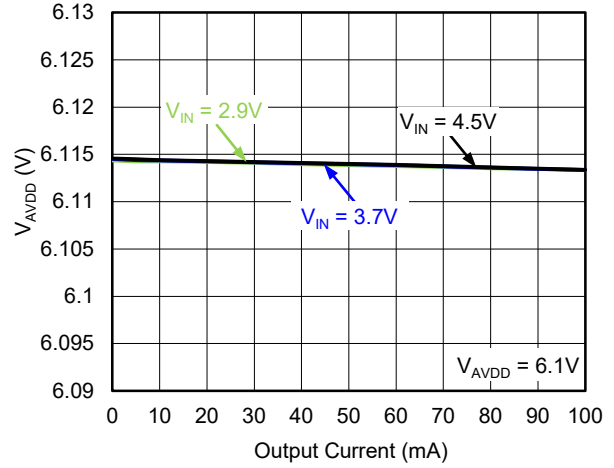

ELVDD Converter Switching Frequency

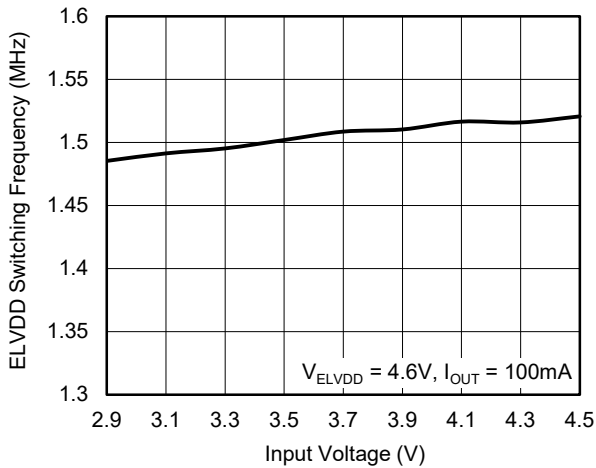

ELVSS Converter Switching Frequency

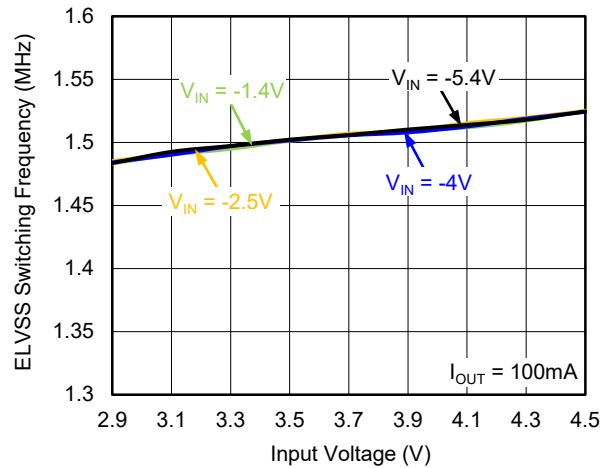

AVDD Converter Switching Frequency

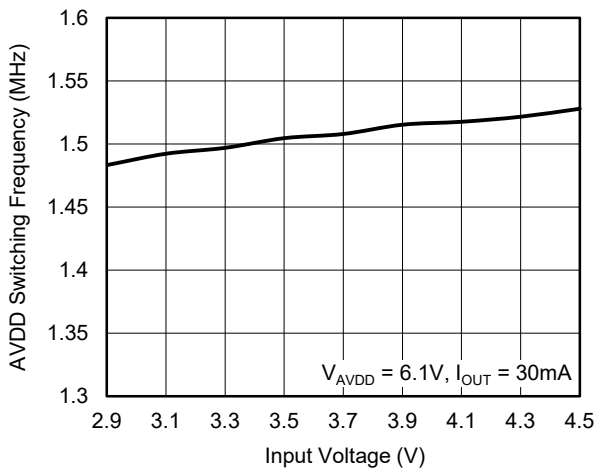

V_{ELVDD} and V_{ELVSS} Combined Maximum Output Current vs. Input Voltage

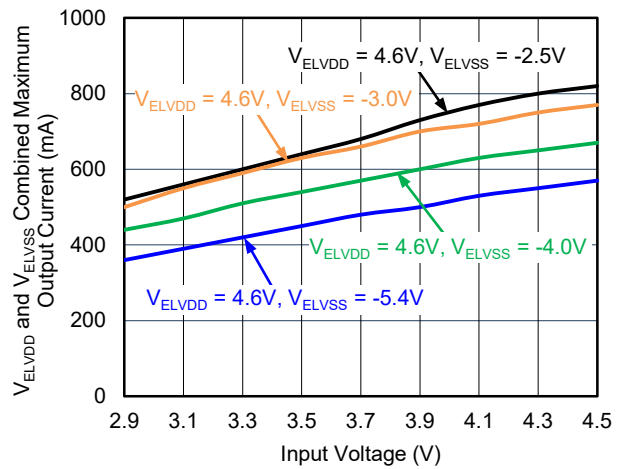

TYPICAL PERFORMANCE CHARACTERISTICS (continued)

At $T_A = +25^\circ\text{C}$, $V_{IN} = 3.7\text{V}$, unless otherwise noted.

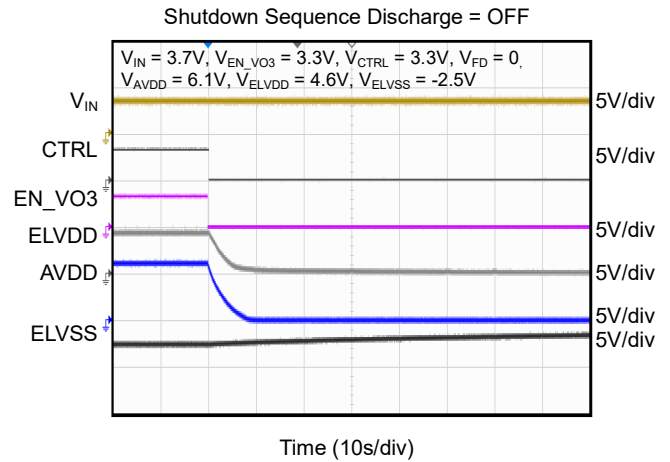
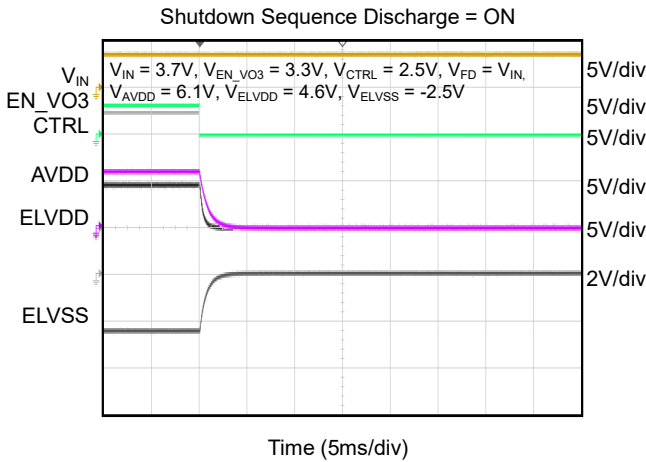
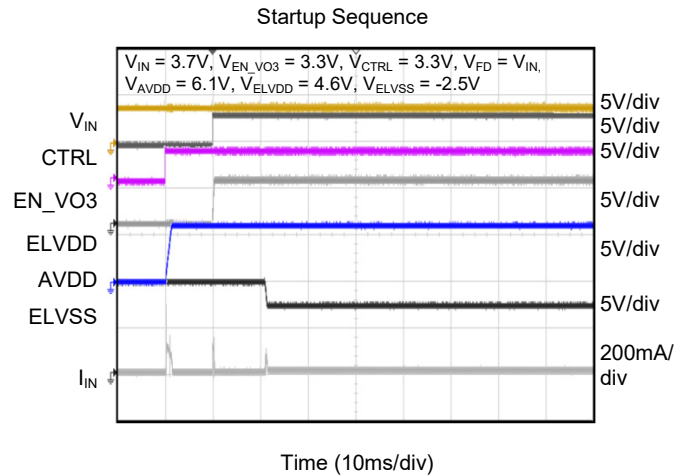
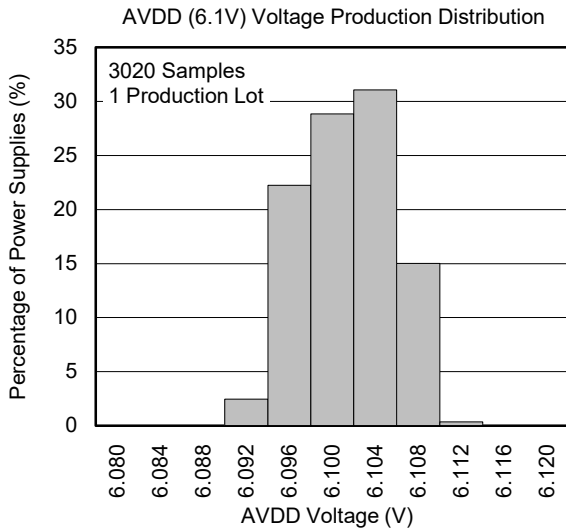
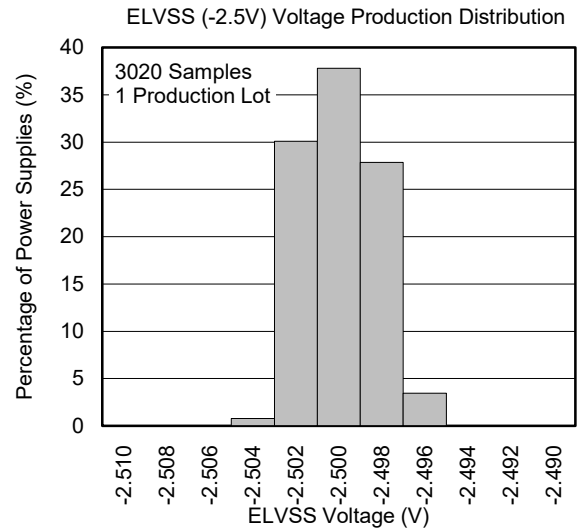
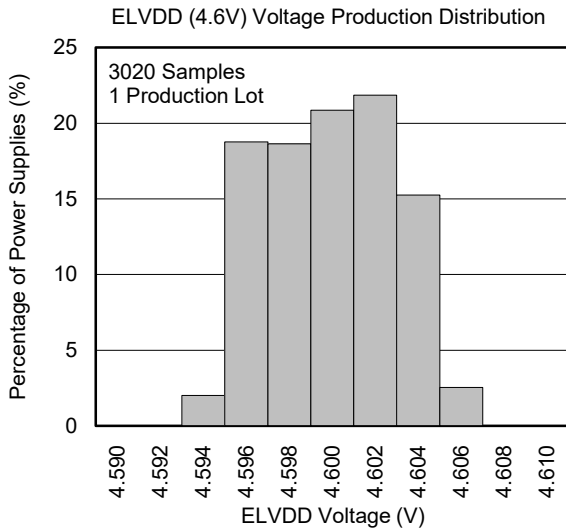

TYPICAL PERFORMANCE CHARACTERISTICS (continued)

At $T_A = +25^\circ\text{C}$, $V_{IN} = 3.7\text{V}$, unless otherwise noted.

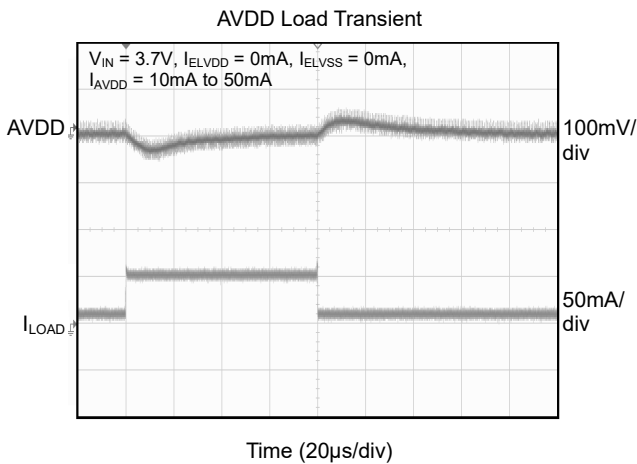
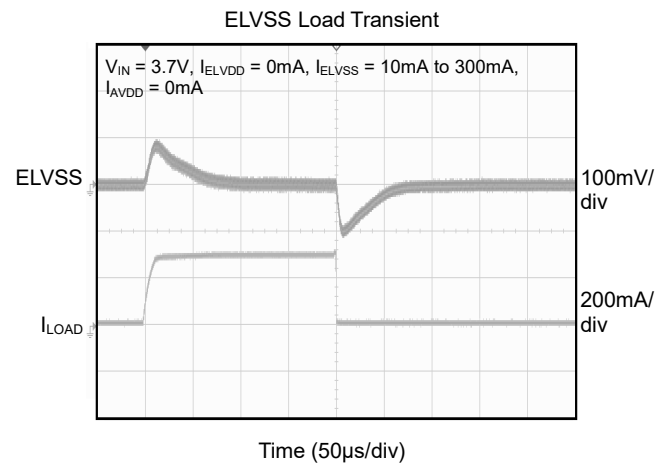
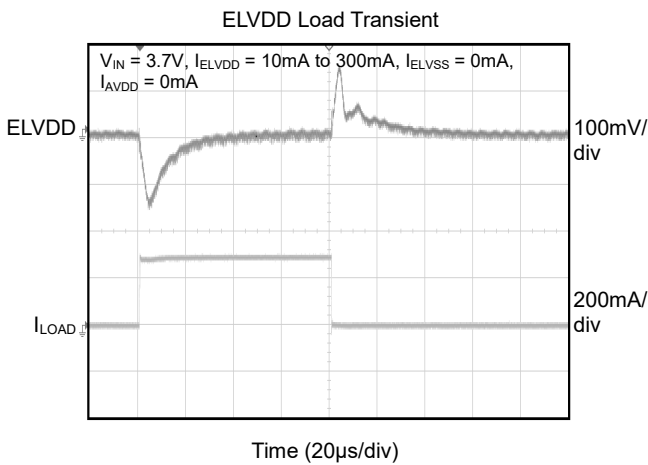
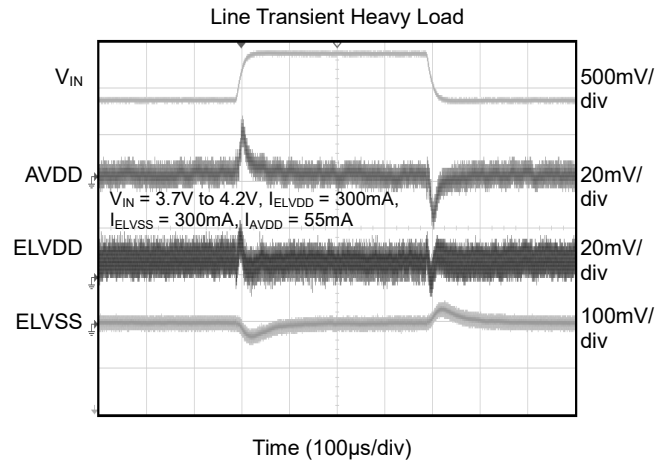
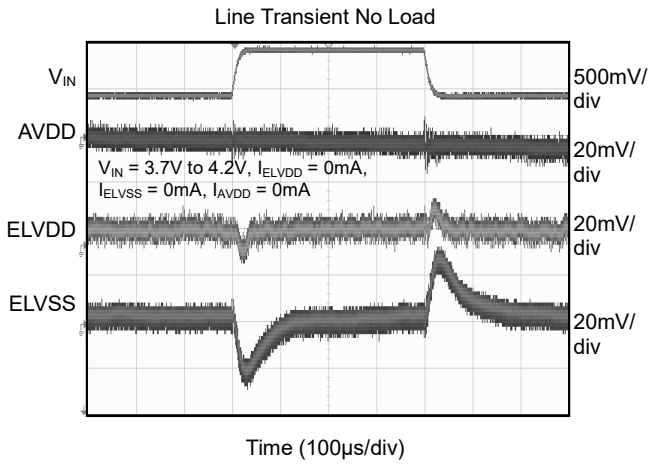

FUNCTIONAL BLOCK DIAGRAM

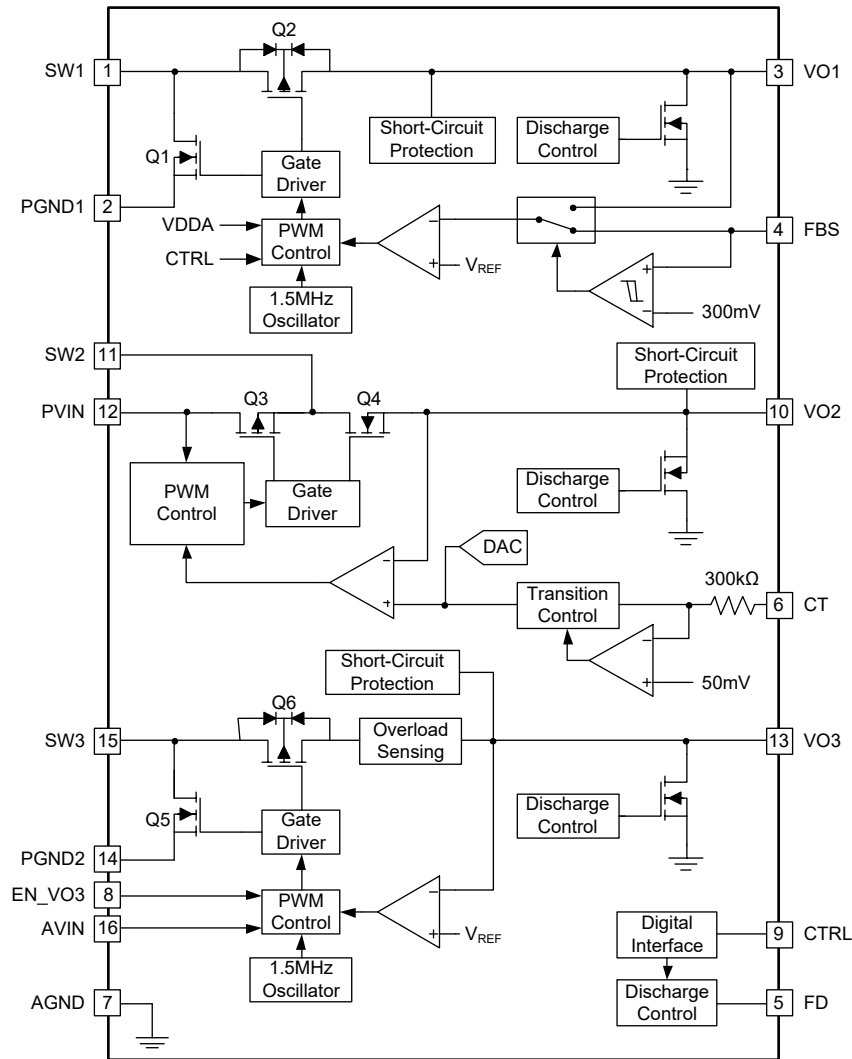

Figure 3. SGM3846 Functional Block Diagram

DETAILED DESCRIPTION

The SGM3846 consists of two boost converters and an inverting buck-boost converter. V_{ELVDD} is programmable in the range of 4.6V to 5.0V (default = 4.6V). V_{ELVSS} is programmable in the range of -1.4V to -5.4V (default = -2.5V) and V_{AVDD} is programmable between 5.8V and 7.9V (default = 6.1V). The transition time when V_{ELVSS} is programmed to a different voltage is adjustable by the CT pin capacitor.

Under-Voltage Lockout

The device has a built-in under-voltage lockout function that disables the device when the input supply voltage is too low for normal operation.

Thermal Shutdown

A thermal shutdown is implemented to prevent damage because of excessive heat and power dissipation. Once a temperature of typically +135°C is exceeded the device shuts down (the programming is not lost). When the temperature decreases to typically +125°C the device automatically restarts performing the start-up sequencing with the same voltages and programming as programmed before the thermal shutdown.

ELVDD Boost Converter (VO1)

The ELVDD boost converter uses a fixed-frequency valley-current-mode topology. The output voltage V_{ELVDD} is adjustable between 4.6V and 5.0V with a default voltage of 4.6V (see Table 1). In shutdown its output is fully isolated (input to output and output to input).

For the highest output voltage accuracy, connect the output sense pin (FBS) directly to the positive pin of the output capacitor. If not used, the FBS pin can be left floating or connected to ground, then the output voltage is sensed at the VO1 pin.

ELVSS Inverting Buck-Boost Converter (VO2)

The ELVSS inverting buck-boost converter uses a fixed-frequency peak-current-mode topology. The output voltage V_{ELVSS} is adjustable between -5.4V and -1.4V with a default voltage of -2.5V (see Table 1). In shutdown its output is fully isolated (input to output and output to input).

AVDD Boost Converter (VO3)

The AVDD boost converter uses a fixed-frequency peak-current-mode topology. The output voltage V_{AVDD} is adjustable between 5.8V and 7.9V with a default voltage of 6.1V (see Table 1). In shutdown its output is fully isolated (input to output and output to input).

Start-Up Sequence, Soft-Start and Shut-Down

The device has an implemented soft-start which limits the inrush current. When V_{IN} is applied, the output discharge is undefined until the rising edge of CTRL sets the output discharge to follow the FD pin setting. When the converters are disabled all outputs are discharged if FD = high or high impedance if FD = low. The typical start-up sequence is shown in Figure 4.

- Pulling EN_VO3 high starts the AVDD boost converter. V_{AVDD} follows a linear 1.5ms long voltage ramp until it reaches its default value of 6.1V, then the switch current is limited to typical 0.2A.
- Pulling CTRL high starts the ELVDD boost converter. V_{ELVDD} starts with a reduced switch current limit of 0.2A until it reaches its default voltage of 4.6V, then the full current limit is released.
- 10ms after CTRL is pulled high the ELVSS inverting buck-boost converter starts. V_{ELVSS} starts with a reduced switch current limit of 0.4A until it reaches its default voltage of -2.5V, then the full current limit is released.

DETAILED DESCRIPTION (continued)

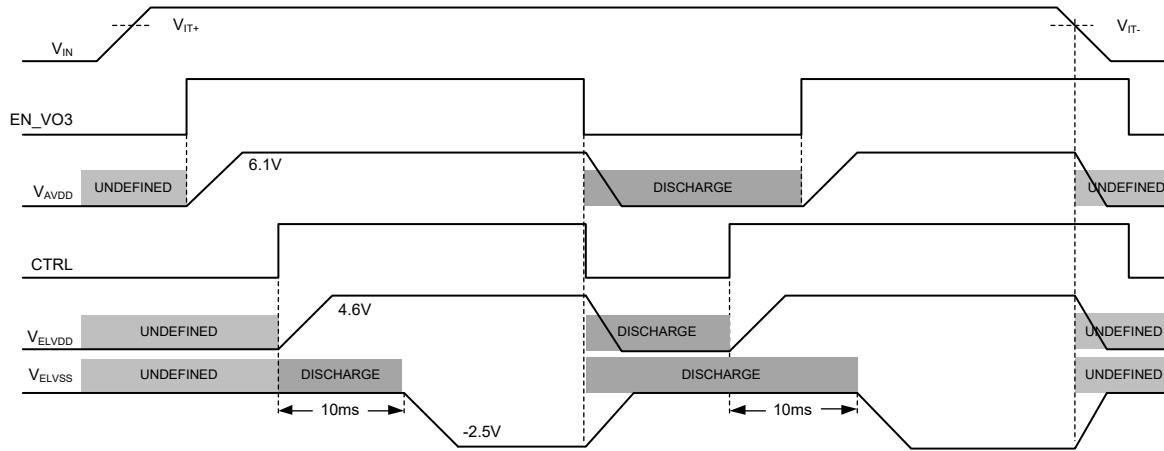

Figure 4. SGM3846 Start-Up Sequencing Active Discharge Enabled

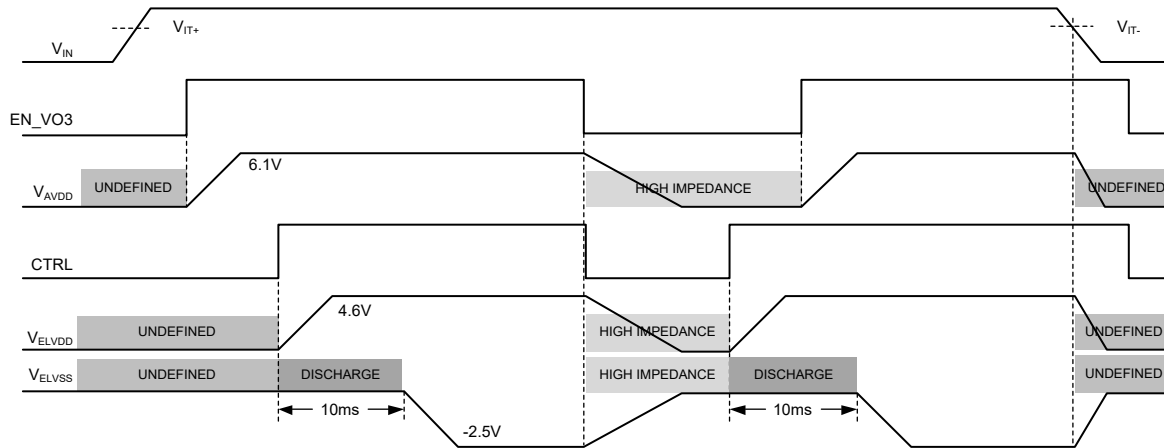

Figure 5. SGM3846 Start-Up Sequencing Active Discharge Disabled

VELVSS Transition Time Control (CT Pin)

The transition time is the time required to move VELVSS from the actual voltage level to the new programmed voltage level. The transition time can be controlled by an external capacitor connected to the CT pin. The typical 50mV CT pin comparator detects when the CT pin is connected to GND or floating, then the fastest possible transition time is used. When a capacitor is

connected the R-C time constant τ sets the transition time. The output voltage is almost settled after 3τ , which means 95% of the target voltage is reached.

$$\begin{aligned} \tau &= \text{Internal CT resistance} \times \text{external capacitor} \\ &= R_{CT} \times C_{CT} \\ &= 300\text{k}\Omega \times 100\text{nF} \\ &= 30\text{ms} \end{aligned}$$



Figure 6. VELVSS Transition Time Control

DETAILED DESCRIPTION (continued)

Digital Interface (CTRL Pin)

The digital interface allows programming of the positive output voltages V_{AVDD} , V_{ELVDD} and the negative output voltage V_{ELVSS} in discrete steps. By default the output discharge during shutdown is controlled by the FD pin, the setting can be overwritten by programming when FD is Low. If programming is not required the CTRL pin

can also be used as a standard enable pin. Once the device is enabled the device starts with its default values (blue marked values in Table 1). The interface counts the rising edges applied to the CTRL pin and sets the new values as shown in Table 1. The settings are stored in a volatile memory. The reset behavior is described in the device reset section.

Table 1. Programming Table

Rising Edges	V_{ELVSS}	Rising Edges	V_{ELVSS}	Rising Edges	V_{AVDD}	Rising Edges	Outputs Discharge	Rising Edges	V_{ELVSS} Transition Time	Rising Edges	V_{ELVDD}
0/no pulse	-2.5V	21	-3.4V	0/no pulse	6.1V	0/no pulse	controlled by FD pin	0/no pulse	controlled by CT pin	0/no pulse	4.6V
1	-5.4V	22	-3.3V	42	7.9V	50	ON	52	reserved	54	4.7V
2	-5.3V	23	-3.2V	43	7.6V	51	OFF	53	reserved	55	4.8V
3	-5.2V	24	-3.1V	44	7.3V					56	4.9V
4	-5.1V	25	-3.0V	45	7.0V					57	5.0V
5	-5.0V	26	-2.9V	46	6.7V						
6	-4.9V	27	-2.8V	47	6.4V						
7	-4.8V	28	-2.7V	48	6.1V						
8	-4.7V	29	-2.6V	49	5.8V						
9	-4.6V	30	-2.5V								
10	-4.5V	31	-2.4V								
11	-4.4V	32	-2.3V								
12	-4.3V	33	-2.2V								
13	-4.2V	34	-2.1V								
14	-4.1V	35	-2.0V								
15	-4.0V	36	-1.9V								
16	-3.9V	37	-1.8V								
17	-3.8V	38	-1.7V								
18	-3.7V	39	-1.6V								
19	-3.6V	40	-1.5V								
20	-3.5V	41	-1.4V								

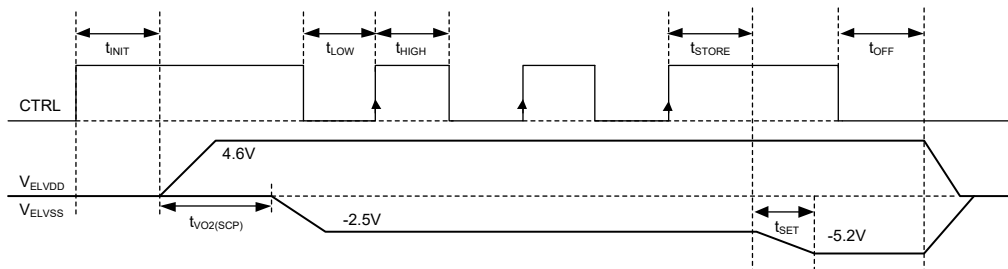

Figure 7. Programming V_{ELVSS}

DETAILED DESCRIPTION (continued)

Short Circuit and Overload Protection

The device is protected against short of V_{AVDD} , V_{ELVDD} and V_{ELVSS} to ground. V_{ELVDD} and V_{ELVSS} are also protected when they are shorted together. A short at any converter and the V_{AVDD} overload protection shuts down the whole device, the shut-down state is latched, and input and outputs are fully disconnected. To reset the whole device V_{IN} has to cycle below under-voltage lockout or EN_VO3 and CTRL have to be low at the same time for minimum t_{OFF} . The device detects a short or an overload when one of the below conditions is fulfilled:

- V_{ELVDD} is not in regulation 10ms after V_{ELVDD} is enabled (10ms CTRL = high) → shut-down all
- V_{ELVSS} is not in regulation 10ms after V_{ELVSS} is enabled (20ms after CTRL = high) → shut-down all
- $V_{(AVDD)}$ protection is enabled when the soft-start is completed.

During Operation:

- V_{AVDD} falls below 90% of its programmed voltage longer than 1ms → shut-down all
- V_{ELVDD} falls below 90% of its programmed voltage longer than 1ms → shut-down all
- V_{ELVSS} rises above 500mV of its programmed voltage longer than 1ms → shut-down all

Enable/Disable Active Discharge During Shutdown

The active discharge during shutdown can be enabled and disabled by the FD pin or by programming. The

programming overwrites the FD pin setting until the function is reset.

- FD pin connected to GND or 51 CTRL pulses → Active discharge is disabled and all outputs are high impedance.
- FD pin connected to HIGH ($V_H > 1.2V$) or 50 CTRL pulses → Active discharge is enabled and all outputs are discharged.

Device Reset

- A power cycle resets all settings to default values as well as the short-circuit protection.
- Enabling the V_{ELVDD} converter (first rising edge of CTRL) resets the output discharge → Output discharge is controlled by FD pin.
- When CTRL is low for t_{OFF} then V_{ELVSS} is reset to default value → -2.5V.
- EN_VO3 and CTRL are low at the same time for t_{OFF} → Short circuit protection is reset.

Operation with $V_{IN} < 2.9V$

The recommended minimum input supply voltage for full performance is 2.9V. The device continues to operate with input supply voltages below 2.9V, however, full performance is not ensured. The device does not operate with input supply voltages below the under-voltage Lockout threshold.

APPLICATION INFORMATION

Figure 1 shows a typical application circuit suitable for supplying AMOLED displays in smartphone applications. The circuit is designed to operate from a single-cell Li-Ion battery and generates positive output voltages V_{AVDD} of 6.1V and V_{ELVDD} of 4.6V as well as a negative output voltage V_{ELVSS} of -2.5V. ELVDD and ELVSS are capable of supplying up to 400mA of output current.

For this design example, use the following input parameters in Table 2.

Table 2. Design Parameters

DESIGN PARAMETER	EXAMPLE VALUE
Input Voltage Range	2.9V to 4.5V
Output Voltage	$V_{AVDD} = 6.1V$, $V_{ELVDD} = 4.6V$, $V_{ELVSS} = -2.5V$
Switching Frequency	ELVDD, ELVSS and AVDD = 1.5MHz

In order to maximize performance, the device has been optimized for use with a relatively narrow range of component values. The V_{AVDD} boost converter typically requires a 10 μ H inductor, V_{ELVDD} and V_{ELVSS} require a 4.7 μ H inductor. Ceramic capacitors are usually used for input and output capacitors. It is recommended to use the suggested values in all applications. Customers using other values are strongly recommended to characterize circuit performance on a case-by-case basis.

ELVDD Boost Converter (VO1)

Inductor Selection

The main parameter for the inductor selection is the inductor saturation current, which must be higher than the peak switch current. Inductors with lower saturation current than the minimum switch current limit can be used when the maximum output current is not required, however a minimum saturation current of 0.5A is required to ensure proper startup. The minimum required saturation current is calculated by the peak inductor current formula.

The inductors DC resistance as well as its core losses affect the efficiency. Lower DC resistance results in higher high load efficiency. The core losses are especially important for light load efficiency. The core material as well as the inductors physical size has an

influence on the core losses. The higher the quality factor Q of the inductor at the switching frequency (1.5MHz) the lower the core losses. Table 3 shows examples of suitable inductors, equivalent parts can be used.

- Minimum 3.3 μ H, maximum 6.1 μ H inductance.
- Minimum 0.5A saturation current, for full output current capability 1.3A.
- Minimum V_{IN} and maximum I_{OUT} must be taken to calculate the required saturation current.
- Duty Cycle:

$$D = \frac{V_{OUT} - V_{IN} \times \eta}{V_{OUT}}$$

where

V_{IN} is the boost converter input supply voltage.

V_{OUT} is the boost converter output voltage.

η is the boost converter efficiency

- Peak Inductor Current:

$$I_{(SW)M} = \frac{I_{OUT}}{1-D} + \frac{V_{IN} \times D}{2 \times f \times L}$$

where

I_{OUT} is the boost converter output current.

$f = 1.5\text{MHz}$ (the boost converter switching frequency).

L is the boost converter inductance (4.7 μ H).

Capacitor Selection

The main parameter for the capacitor selection is the capacitance at the operating voltage. The more voltage is applied at the capacitor the lower is its resulting capacitance (DC-bias effect), also temperature and AC-Voltage changes the capacitance, however the DC-bias effect is dominant. For best voltage filtering (lowest voltage ripple), low ESR capacitors are recommended. Table 4 and Table 5 show examples of suitable capacitors, equivalent parts can be used.

Input Capacitor:

- Minimum 2.5 μ F resulting capacitance.
- Minimum 6.3V voltage rating.

Output Capacitor:

- Minimum 2.5 μ F, maximum 24 μ F resulting capacitance.
- Minimum 6.3V voltage rating.

APPLICATION INFORMATION (continued)

Table 3. ELVDD Boost Converter (VO1) Inductor Selection

INDUCTANCE	I _{SAT}	DCR	MANUFACTURER	PART NUMBER	DIMENSIONS
4.7μH	1.9A	200mΩ	TOKO	DFE252012C-4R7M	2.5mm × 2.0mm × 1.2mm
	2.2A	165mΩ	TOKO	DFE252012P-4R7M	2.5mm × 2.0mm × 1.2mm
	1.5A	175mΩ	ALPS	GLCLM4R701A	2.5mm × 2.0mm × 1.2mm
	1.5A	230mΩ	ALPS	GLCLK4R701A	2.5mm × 2.0mm × 1mm

Table 4. Input Capacitor Selection ELVDD Boost Converter (VO1)

CAPACITANCE	VOLTAGE RATING	MANUFACTURER	PART NUMBER	SIZE
10μF	6.3V	Murata	GRM188R60J106ME84	0603
10μF	10V	Murata	GRM219R61A106ME47	0805
22μF	10V	Samsung	CL21A226MPCLRNC	0805

Table 5. Output Capacitor Selection ELVDD Boost Converter (VO1)

CAPACITANCE	VOLTAGE RATING	MANUFACTURER	PART NUMBER	SIZE
10μF	10V	Murata	GRM219R61A106ME47	0805
22μF	10V	Samsung	CL21A226MPCLRNC	0805

ELVSS Inverting Buck-Boost Converter (VO2)

Inductor Selection

The main parameter for the inductor selection is the inductor saturation current, which must be higher than the peak switch current. Inductors with lower saturation current than the minimum switch current limit can be used when the maximum output current is not required, however a minimum saturation current of 0.5A is required to ensure proper startup. The minimum required saturation current is calculated by the peak inductor current formula.

The inductors DC resistance as well as its core losses affect the efficiency. Lower DC resistance results in higher high load efficiency. The core losses are especially important for light load efficiency. The core material as well as the inductors physical size has an influence on the core losses. The higher the quality factor Q of the inductor at the switching frequency (1.5MHz) the lower the core losses. Table 6 shows examples of suitable inductors, equivalent parts can be used.

- Minimum 3.3μH, maximum 6.1μH inductance.
- Minimum 0.5A saturation current, for full output current capability 1.5A.

- Minimum V_{IN} and maximum I_O must be taken to calculate the required saturation current.

- Duty Cycle:

$$D = \frac{V_{OUT}}{V_{OUT} - V_{IN} \times \eta}$$

where

V_{IN} is the inverting buck-boost converter input supply voltage.

V_{OUT} is the inverting buck-boost converter output voltage.

η is the inverting buck-boost converter efficiency.

- Peak Inductor Current:

$$I_{(SW)M} = \frac{I_{OUT}}{1-D} + \frac{V_{IN} \times D}{2 \times f \times L}$$

where

I_{OUT} is the inverting buck-boost converter output current.

f = 1.5MHz (the inverting buck-boost converter switching frequency).

L is the inverting buck-boost converter inductance (4.7μH).

APPLICATION INFORMATION (continued)

Capacitor Selection

The main parameter for the capacitor selection is the capacitance at the operating voltage. The more voltage is applied at the capacitor the lower is its resulting capacitance (DC-bias effect), also temperature and AC-Voltage changes the capacitance, however the DC-bias effect is dominant. For best voltage filtering (lowest voltage ripple), low ESR capacitors are recommended. Table 7 and Table 8 show examples of suitable capacitors, equivalent parts can be used.

Input Capacitor:

- Minimum 2.5µF resulting capacitance.
- Minimum 6.3V voltage rating.

Output Capacitor:

- Minimum 2.5µF, maximum 24µF resulting capacitance.
- Minimum 10V voltage rating, when maximum -6V are used also 6.3V rated capacitors can be used.

Table 6. ELVSS Inverting Buck-Boost Converter (VO2) Inductor Selection

INDUCTANCE	I _{SAT}	DCR	MANUFACTURER	PART NUMBER	DIMENSIONS
4.7µH	1.9A	200mΩ	TOKO	DFE252012C-4R7M	2.5mm × 2.0mm × 1.2mm
	2.2A	165mΩ	TOKO	DFE252012P-4R7M	2.5mm × 2.0mm × 1.2mm
	1.5A	175mΩ	ALPS	GLCLM4R701A	2.5mm × 2.0mm × 1.2mm
	1.5A	230mΩ	ALPS	GLCLK4R701A	2.5mm × 2.0mm × 1mm

Table 7. Input Capacitor Selection ELVSS Inverting Buck-Boost Converter (VO2)

CAPACITANCE	VOLTAGE RATING	MANUFACTURER	PART NUMBER	SIZE
10µF	6.3V	Murata	GRM188R60J106ME84	0603
10µF	10V	Murata	GRM219R61A106ME47	0805
22µF	10V	Samsung	CL21A226MPCLRNC	0805

Table 8. Output Capacitor Selection ELVSS Inverting Buck-Boost Converter (VO2)

CAPACITANCE	VOLTAGE RATING	MANUFACTURER	PART NUMBER	SIZE
10µF	10V	Murata	GRM219R61A106ME47	0805
22µF	10V	Samsung	CL21A226MPCLRNC	0805

AVDD Boost Converter (VO3)

Inductor Selection

The main parameter for the inductor selection is the inductor saturation current, which must be higher than the peak switch current. Inductors with lower saturation current than the minimum switch current limit can be used when the maximum output current is not required, however a minimum saturation current of 0.2A is required to ensure proper startup. The minimum required saturation current is calculated by the peak inductor current formula.

The inductors DC resistance as well as its core losses affect the efficiency. Lower DC resistance results in higher high load efficiency. The core losses are especially important for light load efficiency. The core material as well as the inductors physical size has an influence on the core losses. The higher the quality

factor Q of the inductor at the switching frequency (1.5MHz) the lower the core losses. Table 9 shows examples of suitable inductors, equivalent parts can be used.

- Minimum 7µH, maximum 13µH inductance.
- Minimum 0.2A saturation current, for full output current capability 0.25A.
- Minimum V_{IN} and maximum I_O must be taken to calculate the required saturation current.
- Duty Cycle:

$$D = \frac{V_{OUT} - V_{IN} \times \eta}{V_{OUT}}$$

where

V_{IN} is the boost converter input supply voltage.

V_{OUT} is the boost converter output voltage.

η is the boost converter efficiency

APPLICATION INFORMATION (continued)

- Peak Inductor Current:

$$I_{(SW)M} = \frac{I_{OUT}}{1-D} + \frac{V_{IN} \times D}{2 \times f \times L}$$

where

I_{OUT} is the boost converter output current.

$f = 1.5\text{MHz}$ (the boost converter switching frequency).

L is the boost converter inductance (10 μH)

Capacitor Selection

The main parameter for the capacitor selection is the capacitance at the operating voltage. The more voltage is applied at the capacitor the lower is its resulting capacitance (DC-bias effect), also temperature and

AC-Voltage changes the capacitance, however the DC-bias effect is dominant. For best voltage filtering (lowest voltage ripple), low ESR capacitors are recommended. Table 10 and Table 11 show examples of suitable capacitors, equivalent parts can be used.

Input Capacitor:

- Minimum 2.5 μF resulting capacitance.
- Minimum 6.3V voltage rating.

Output Capacitor:

- Minimum 2.5 μF , maximum 24 μF resulting capacitance.
- Minimum 10V voltage rating .

Table 9. AVDD Boost Converter (VO3) Inductor Selection

INDUCTANCE	I_{SAT}	DCR	MANUFACTURER	PART NUMBER	DIMENSIONS
10 μH	1.3A	400m Ω	TOKO	DFE252012C-100M	2.5mm × 2.0mm × 1.2mm
	1.2A	530m Ω	TOKO	DFE252010C-100M	2.5mm × 2.0mm × 1mm
	0.75A	600m Ω	Taiyo Yuden	MDKK2020T-100MM	2mm × 2mm × 1mm
	0.8A	359m Ω	CYNTEC	SDET25201B-100MS	2.5mm × 2mm × 1.2mm
	0.48A	817m Ω	CYNTEC	SDER20121T-100MS	2.0mm × 1.2mm × 1mm

Table 10. Input Capacitor Selection AVDD Boost Converter (VO3)

CAPACITANCE	VOLTAGE RATING	MANUFACTURER	PART NUMBER	SIZE
10 μF	6.3V	Murata	GRM188R60J106ME84	0603
10 μF	10V	Murata	GRM219R61A106ME47	0805
22 μF	10V	Samsung	CL21A226MPCLRNC	0805

Table 11. Output Capacitor Selection AVDD Boost Converter (VO3)

CAPACITANCE	VOLTAGE RATING	MANUFACTURER	PART NUMBER	SIZE
10 μF	10V	Murata	GRM219R61A106ME47	0805
22 μF	10V	Samsung	CL21A226MPCLRNC	0805

APPLICATION INFORMATION (continued)

Power Supply Recommendations

The SGM3846 device is designed to operate with input supplies from 2.9V to 4.5V. The input supply should be stable and free of noise if the device's full performance is to be achieved. If the input supply is located more than a few centimeters away from the device, additional bulk capacitance may be required. The input capacitance shown in the Application Information is sufficient for typical applications.

Layout Guideline

The PCB layout is an important step in the power supply design. An incorrect layout could cause converter instability, load regulation problems, noise, and EMI issues. Especially with a switching DC/DC converter at high load currents, too thin PCB traces can cause significant voltage spikes. Good grounding becomes important as well. If possible a common

ground plane to minimize ground shifts between analog ground (GND) and power ground (PGND) is recommended.

- Place the input capacitor on PVIN and the output capacitor on VO2 as close as possible to the device. Use short and wide traces to connect the input capacitor on PVIN and the output capacitor on VO2.
• Place the output capacitor on VO1 and VO3 as close as possible to the device. Use short and wide traces to connect the output capacitor on VO1 and VO3.
• Connect the ground of the CT capacitor with AGND (pin 7) directly.
• Connect input ground and output ground on the same board layer, not through via hole.
• Connect AGND, PGND1 and PGND2 with the exposed thermal pad.

REVISION HISTORY

NOTE: Page numbers for previous revisions may differ from page numbers in the current version.

Changes from Original (NOVEMBER 2018) to REV.A

Table with 2 columns: Change description and Page number. Row 1: Changed from product preview to production data... All

PACKAGE INFORMATION

PACKAGE OUTLINE DIMENSIONS

TQFN-3×3-16L

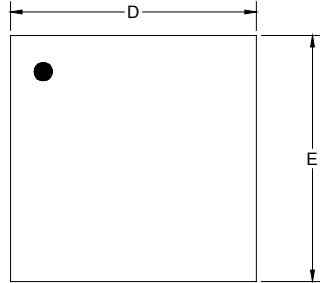

TOP VIEW

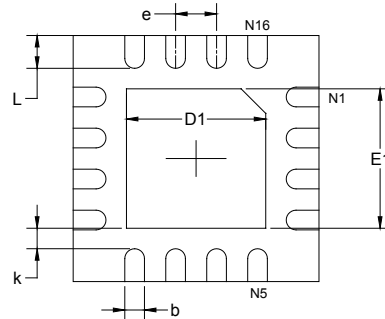

BOTTOM VIEW

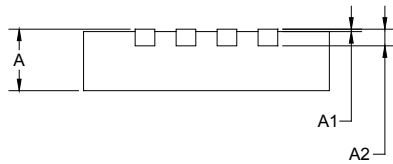

SIDE VIEW

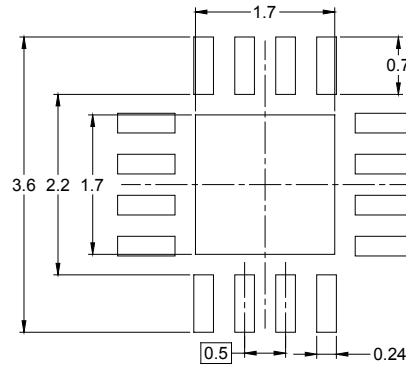

RECOMMENDED LAND PATTERN (Unit: mm)

Symbol	Dimensions In Millimeters		Dimensions In Inches	
	MIN	MAX	MIN	MAX
A	0.700	0.800	0.028	0.031
A1	0.000	0.050	0.000	0.002
A2	0.203 REF		0.008 REF	
D	2.900	3.100	0.114	0.122
D1	1.600	1.800	0.063	0.071
E	2.900	3.100	0.114	0.122
E1	1.600	1.800	0.063	0.071
k	0.200 MIN		0.008 MIN	
b	0.180	0.300	0.007	0.012
e	0.500 TYP		0.020 TYP	
L	0.300	0.500	0.012	0.020

PACKAGE INFORMATION

TAPE AND REEL INFORMATION

REEL DIMENSIONS



TAPE DIMENSIONS



NOTE: The picture is only for reference. Please make the object as the standard.

KEY PARAMETER LIST OF TAPE AND REEL

Package Type	Reel Diameter	Reel Width W1 (mm)	A0 (mm)	B0 (mm)	K0 (mm)	P0 (mm)	P1 (mm)	P2 (mm)	W (mm)	Pin1 Quadrant
TQFN-3×3-16L	13"	12.4	3.35	3.35	1.13	4.0	8.0	2.0	12.0	Q2

DD0001

PACKAGE INFORMATION

CARTON BOX DIMENSIONS



NOTE: The picture is only for reference. Please make the object as the standard.

KEY PARAMETER LIST OF CARTON BOX

Reel Type	Length (mm)	Width (mm)	Height (mm)	Pizza/Carton
13"	386	280	370	5

DD0002