

GENERAL DESCRIPTION

The SGM6232 is a current-mode step-down regulator with an internal power MOSFET. This device achieves 2A continuous output current over a wide input supply range from 4.5V to 38V with excellent load and line regulations. The switching frequency of SGM6232 is 1.4MHz and current mode operation provides fast transient response and eases loop stabilization.

The SGM6232 is highly efficient with peak efficiency at 91% when in operation. In shutdown mode the regulator draws less than 18µA of supply current. Protection features include cycle-by-cycle current limit and thermal shutdown. The device also includes an internal soft-start and an external adjustable soft-start function to limit the inrush current and prevent the overshoot of output voltage.

The SGM6232 is available in Green SOIC-8 (Exposed Pad) package and requires a minimum number of readily available external components to complete a 2A step- down DC/DC converter solution.

FEATURES

- 2A Output Current
- High Efficiency: Up to 91%
- 4.5V to 38V Input Voltage Range
- < 18µA Shutdown Supply Current
- 100mΩ Internal Power MOSFET Switch
- Fixed 1.4MHz Switching Frequency
- Output Adjustable from 0.8V to 28V
- Cycle-by-Cycle Current Limit Protection
- Thermal Shutdown Protection
- Under-Voltage Lockout
- Stable with Low ESR Ceramic Capacitors
- -40°C to +85°C Operating Temperature Range
- Available in Green SOIC-8 (Exposed Pad) Package

APPLICATIONS

- Distributed Power Systems
- Battery Chargers
- Flat Panel TVs
- Set-Top Boxes
- Pre-Regulator for Linear Regulators
- Cigarette Lighter Powered Devices
- DVD/PVR Devices

TYPICAL APPLICATION

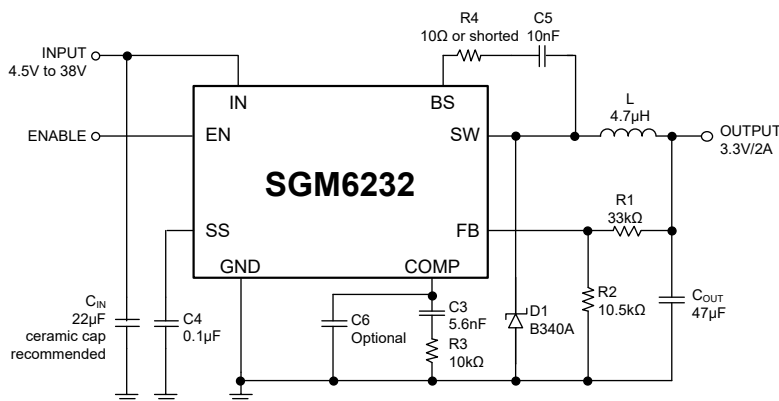
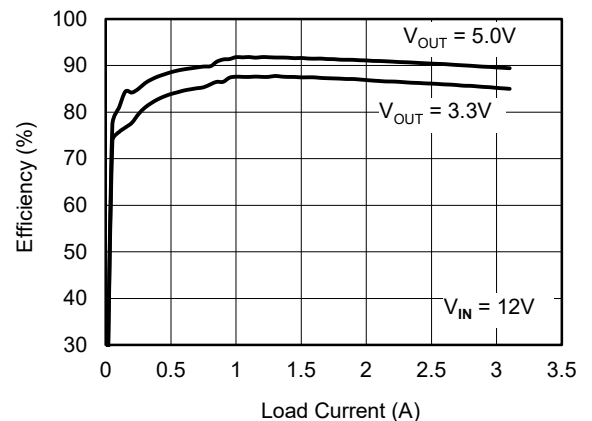

Figure 1. Typical Application Circuit



PACKAGE/ORDERING INFORMATION

MODEL	PACKAGE DESCRIPTION	SPECIFIED TEMPERATURE RANGE	ORDERING NUMBER	PACKAGE MARKING	PACKING OPTION
SGM6232	SOIC-8 (Exposed Pad)	-40°C to +85°C	SGM6232YPS8G/TR	SGM 6232YPS8 XXXXX	Tape and Reel, 2500

NOTE: XXXXX = Date Code and Vendor Code.

Green (RoHS & HSF): SG Micro Corp defines "Green" to mean Pb-Free (RoHS compatible) and free of halogen substances. If you have additional comments or questions, please contact your SGMICRO representative directly.

ABSOLUTE MAXIMUM RATINGS

Supply Voltage, V_{IN} -0.3V to 40V
 SW Voltage, V_{SW}-0.5V to $V_{IN} + 0.3V$
 Boost Voltage, V_{BS} $V_{SW} - 0.3V$ to $V_{SW} + 6V$
 All Other Pins..... -0.3V to 6V
 Package Thermal Resistance
 SOIC-8 (Exposed Pad), θ_{JA} 50°C/W
 Operating Temperature Range -40°C to +85°C
 Junction Temperature.....+150°C
 Storage Temperature Range-65°C to +150°C
 Lead Temperature (Soldering, 10s).....+260°C
 ESD Susceptibility
 HBM.....4000V
 MM.....200V

OVERSTRESS CAUTION

Stresses beyond those listed may cause permanent damage to the device. Functional operation of the device at these or any other conditions beyond those indicated in the operational section of the specification is not implied. Exposure to absolute maximum rating conditions for extended periods may affect reliability.

ESD SENSITIVITY CAUTION

This integrated circuit can be damaged by ESD if you don't pay attention to ESD protection. SGMICRO recommends that all integrated circuits be handled with appropriate precautions. Failure to observe proper handling and installation procedures can cause damage. ESD damage can range from subtle performance degradation to complete device failure. Precision integrated circuits may be more susceptible to damage because very small parametric changes could cause the device not to meet its published specifications.

DISCLAIMER

SG Micro Corp reserves the right to make any change in circuit design, specification or other related things if necessary without notice at any time.

PIN CONFIGURATION

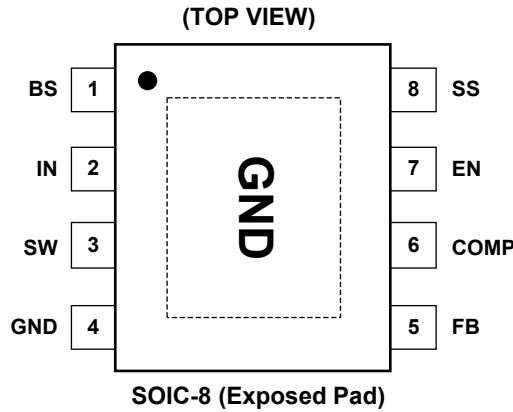

PIN DESCRIPTION

PIN	NAME	FUNCTION
1	BS	High-side Gate Drive Boost Input. BS supplies the driver for the high-side N-Channel MOSFET switch. Connect a 10nF or greater capacitor from SW to BS to power the high-side switch. A 10Ω resistor placed between SW and BS cap is strongly recommended to reduce SW spike voltage.
2	IN	Power Input. IN supplies the power to the IC, as well as the step-down converter switches. Drive IN with a 4.5V to 38V power source. Bypass IN to GND with a sufficiently large capacitor to eliminate noise on the input to the IC.
3	SW	Power Switching Output. SW is the switching node that supplies power to the output. Connect the output LC filter from SW to the output load. Note that a capacitor is required from SW to BS to power the high-side switch.
4	GND	Ground. (Connect the exposed pad on backside to pin 4.)
5	FB	Feedback Input. The voltage at this pin is regulated to 0.8V. Connected to the resistor divider between output and ground to set output voltage.
6	COMP	Compensation Node. COMP is used to compensate the regulation control loop. Connect a series RC network from COMP to GND to compensate the regulation control loop. In some cases, an additional capacitor from COMP to GND is required.
7	EN	Enable Input. EN is a digital input that turns the regulator on or off. Drive EN high to turn on the regulator, and drive EN low to turn it off. Output voltage is discharged when the IC is off. For automatic startup, leave EN unconnected.
8	SS	Soft-Start Control Input. SS controls the soft-start period. Connect a capacitor from SS to GND to set the soft-start period. A 0.1μF capacitor sets the soft-start period to 10ms. To disable the soft-start feature, leave SS unconnected.
Exposed Pad	GND	Power Ground Exposed Pad. Must be connected to GND plane.

ELECTRICAL CHARACTERISTICS(V_{IN} = 12V, T_A = +25°C, unless otherwise noted.)

PARAMETER	SYMBOL	CONDITIONS	MIN	TYP	MAX	UNITS
Input Voltage Range	V _{IN}		4.5		38	V
Feedback Voltage	V _{FB}		0.776	0.8	0.824	V
Shutdown Supply Current	I _{SHDN}	V _{EN} = 0V		10	18	μA
Quiescent Supply Current	I _Q	V _{EN} = 2.6V, V _{FB} = 1V		0.8	1.7	mA
High-side Switch (M1) On-Resistance	R _{ONH}			100		mΩ
Low-side Switch (M2) On-Resistance	R _{ONL}			10		Ω
Error Amplifier Transconductance	G _{EA}	ΔV _{FB} = ±12.5mV	500	800	1120	μA/V
Error Amplifier Voltage Gain	A _{EA}			10000		V/V
SW Leakage Current	I _{LSW}	V _{EN} = 0V, V _{SW} = 0V			1	μA
Current Limit	I _{LIM}			4.2		A
Current Sense to COMP Transconductance	G _{CS}			6.2		A/V
Maximum Duty Cycle	D _{MAX}	V _{FB} = 0.6V		80		%
Minimum Duty Cycle	D _{MIN}	V _{FB} = 1V		0		%
EN Threshold Voltage	V _{IH}		1.2			V
EN Threshold Voltage	V _{IL}				0.4	V
EN Pull-Up Current		V _{EN} = 0V	0.8	1.4	2	μA
Oscillator Frequency	f _{OSC}		1.15	1.4	1.6	MHz
Short Circuit Oscillator Frequency		V _{FB} = 0V		140		kHz
Under-Voltage Lockout Threshold		V _{IN} Rising	3.5	3.8	4.2	V
Under-Voltage Lockout Threshold Hysteresis				230		mV
Soft-Start Period		C _{SS} = 0.1μF		10		ms
Thermal Shutdown Temperature	T _{SHDN}			160		°C

TYPICAL PERFORMANCE CHARACTERISTICS

$V_{IN} = 12V$, $C_{IN} = 22\mu F$, $C_{OUT} = 47\mu F$ and $T_A = +25^\circ C$, unless otherwise noted.

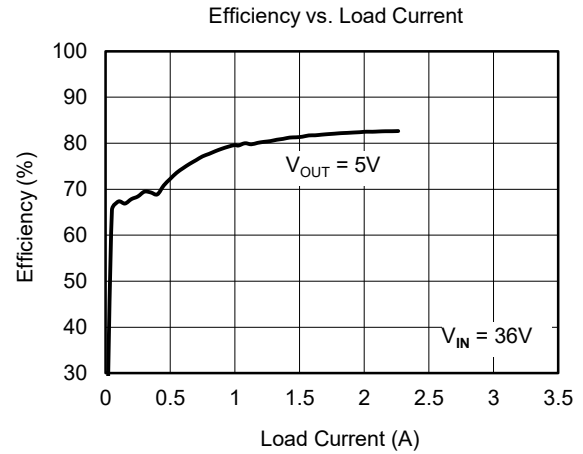
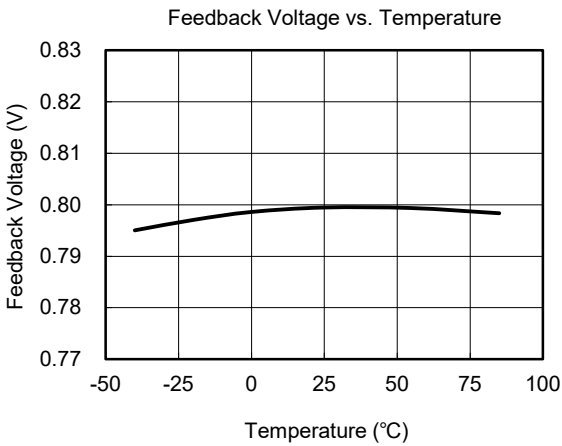
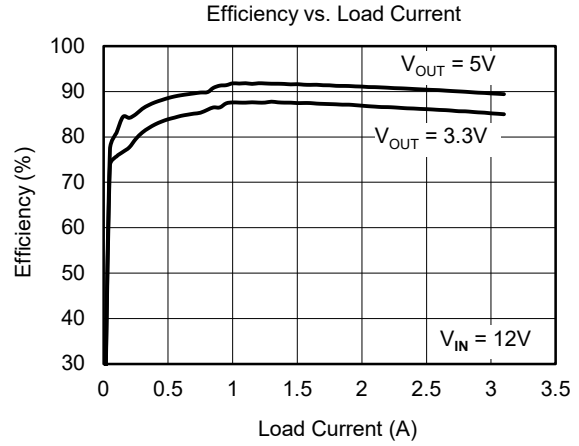
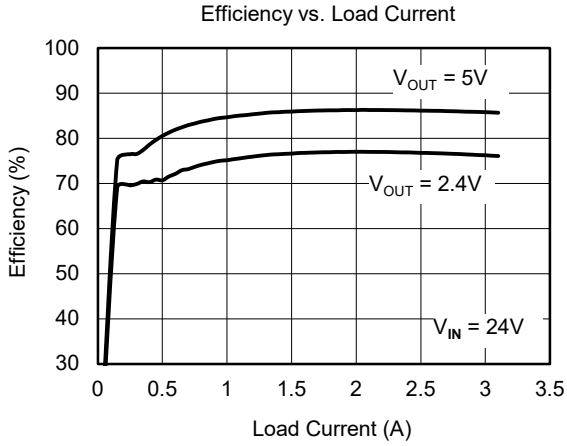

TYPICAL PERFORMANCE CHARACTERISTICS (continued)

$V_{IN} = 12V$, $C_{IN} = 22\mu F$, $C_{OUT} = 47\mu F$ and $T_A = +25^\circ C$, unless otherwise noted.

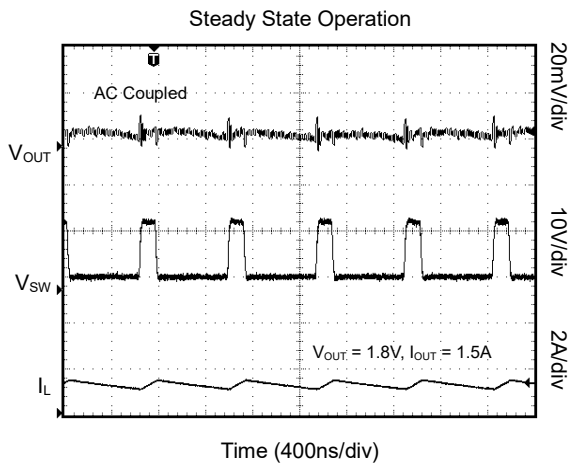
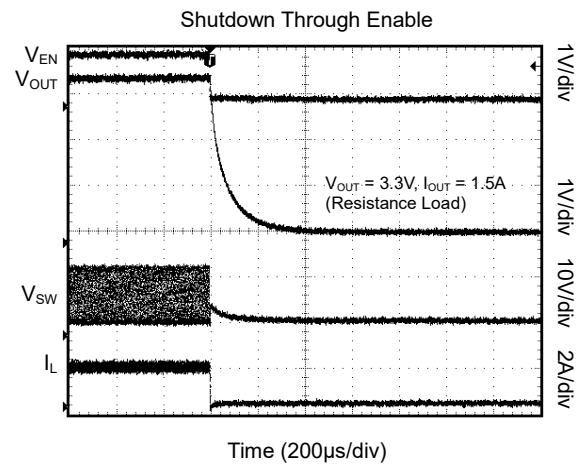
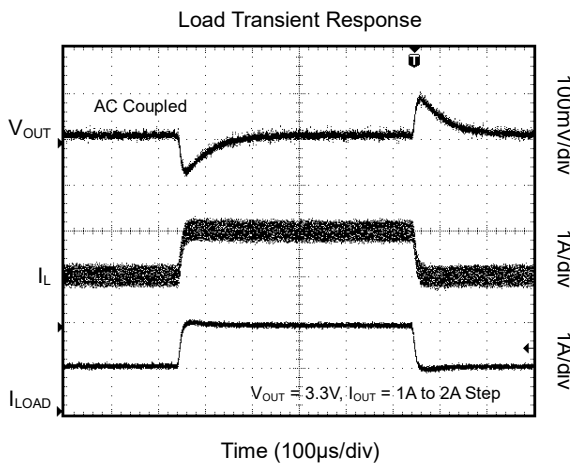
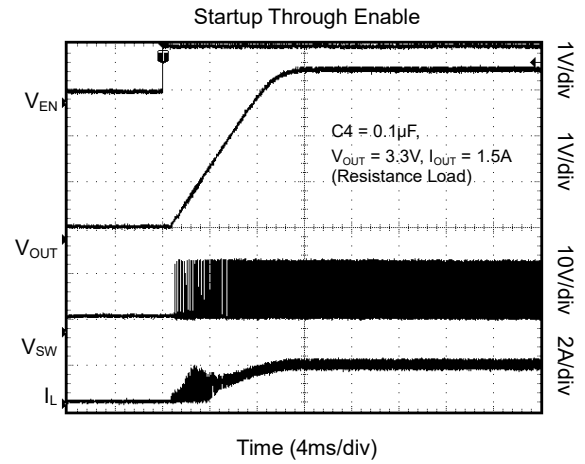
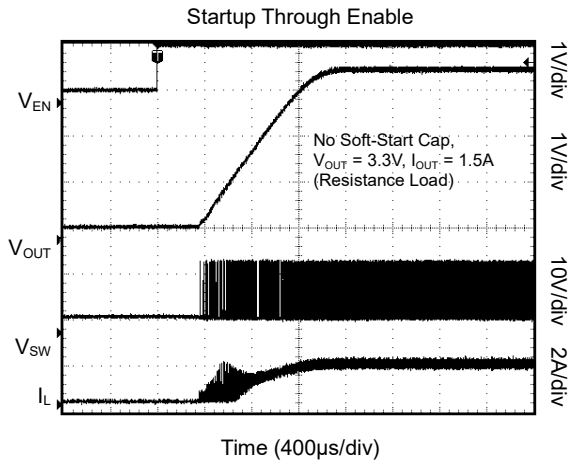

OPERATION

The SGM6232 is a current-mode step-down regulator. It regulates input voltages from 4.5V to 38V down to an output voltage as low as 0.8V, and is able to supply up to 2A of load current.

The SGM6232 uses current-mode control to regulate the output voltage. The output voltage is measured at FB through a resistive voltage divider and amplified through the internal error amplifier. The output current of the transconductance error amplifier is presented at COMP where a network compensates the regulation control system. The voltage at COMP is compared to the switch current measured internally to control the output voltage.

The converter uses an internal N-Channel MOSFET switch to step-down the input voltage to the regulated output voltage. A boost capacitor connected between SW and BS drives the gate of MOSFET, and makes it greater than input voltage while SW is high. Thus, the MOSFET will be in low resistance conducting state. The capacitor is internally charged while SW is low.

An internal 10Ω switch from SW to GND is used to ensure that SW is pulled to GND during shutdown to fully charge the BS capacitor.

Soft-Start

The device includes a soft-start to limit the inrush current and prevent the overshoot of output voltage. The soft-start time can be programmed by the external soft-start capacitor and it is calculated as:

$$t_{SS} = 100k\Omega \times C_{SS}$$

For example, $C_{SS} = 0.1\mu\text{F}$ corresponds to a 10ms soft-start time.

To get perfect power on start performance, right soft-start time must be added to adjust the sequence between power supply and the output voltage in order to guarantee the self-boost capacitor is charged correctly. Usually a 1μF C_{SS} is good enough, if the power supply is decoupled by big input capacitor, a long soft-start time is preferred.

APPLICATION INFORMATION

Setting the Output Voltage

The output voltage is set using a resistive voltage divider from the output voltage to FB pin. The voltage divider divides the output voltage down to the feedback voltage by the ratio:

$$V_{FB} = V_{OUT} \frac{R2}{R1+R2}$$

Where V_{FB} is the feedback voltage and V_{OUT} is the output voltage. Thus the output voltage is:

$$V_{OUT} = 0.8 \times \frac{R1+R2}{R2}$$

The value for R2 can be as high as 100k Ω , but a typical value is 10k Ω . Using that value, R1 is determined by:

$$R1 = 12.5 \times (V_{OUT} - 0.8) \text{ (k}\Omega\text{)}$$

For example, for a 3.3V output voltage, R2 is 10k Ω , and R1 is 31.25k Ω .

Inductor

The inductor is required to supply constant current to the output load while being driven by the switched input voltage. A larger value inductor will result in less ripple current that will result in lower output ripple voltage. However, the larger value inductor will have a larger physical size, higher series resistance, and/or lower saturation current. A good rule for determining the inductance to use is to allow the peak-to-peak ripple current in the inductor to be approximately 30% of the maximum switch current limit. Also, make sure that the peak inductor current is below the maximum switch current limit. The inductance value can be calculated by:

$$L = \frac{V_{OUT}}{f_{OSC} \times \Delta I_L} \times \left(1 - \frac{V_{OUT}}{V_{IN}}\right)$$

Where V_{IN} is the input voltage, f_{OSC} is the 1.4MHz switching frequency, and ΔI_L is the peak-to-peak inductor ripple current.

Choose an inductor that will not saturate under the maximum inductor peak current. The peak inductor current can be calculated by:

$$I_{LP} = I_{LOAD} + \frac{V_{OUT}}{2 \times f_{OSC} \times L} \times \left(1 - \frac{V_{OUT}}{V_{IN}}\right)$$

I_{LOAD} is the load current.

Output Rectifier Diode

The output rectifier diode supplies the current to the inductor when the high-side switch is off. To reduce losses due to the diode forward voltage and recovery times, use a Schottky diode.

Choose a diode whose maximum reverse voltage rating is greater than the maximum input voltage, and whose current rating is greater than the maximum load current. Table 1 lists example Schottky diodes and manufacturers.

Table 1. Diode Selection Guide

Diode	Voltage, Current Rating	Manufacturer
SK33	30V, 3A	Diodes Inc.
SK34	40V, 3A	Diodes Inc.
B330	30V, 3A	Diodes Inc.
B340	40V, 3A	Diodes Inc.
MBRS330	30V, 3A	On Semiconductor
MBRS340	40V, 3A	On Semiconductor

Input Capacitor

The input current to the step-down converter is discontinuous, therefore a capacitor is required to supply the AC current to the step-down converter while maintaining the DC input voltage. Use low ESR capacitors for the best performance. Ceramic capacitors are recommended.

Since the input capacitor absorbs the input switching current, it requires an adequate ripple current rating.

The RMS current in the input capacitor can be estimated by:

$$I_{RMS} = I_{LOAD} \times \sqrt{\frac{V_{OUT}}{V_{IN}} \times \left(1 - \frac{V_{OUT}}{V_{IN}}\right)}$$

The worst-case condition occurs at $V_{IN} = 2V_{OUT}$, where:

$$I_{RMS(MAX)} = \frac{I_{LOAD}}{2}$$

For simplification, choose the input capacitor whose RMS current rating is greater than half of the maximum load current.

APPLICATION INFORMATION (continued)

The input capacitor can be electrolytic, tantalum or ceramic. When using electrolytic or tantalum capacitors, a small, high quality ceramic capacitor, i.e. 0.1μF, should be placed as close to the IC as possible. When using ceramic capacitors, make sure that they have enough capacitance to provide sufficient charge to prevent excessive voltage ripple at input. The input voltage ripple caused by capacitance can be estimated by:

$$\Delta V_{IN} = \frac{I_{LOAD}}{f_{OSC} \times C_{IN}} \times \frac{V_{OUT}}{V_{IN}} \times \left(1 - \frac{V_{OUT}}{V_{IN}}\right)$$

C_{IN} is the input capacitance value.

Output Capacitor

The output capacitor (C_{OUT}) is required to maintain the DC output voltage. Ceramic, tantalum, or low ESR electrolytic capacitors are recommended.

Low ESR capacitors are preferred to keep the output voltage ripple low. The output voltage ripple can be estimated by:

$$\Delta V_{OUT} = \frac{V_{OUT}}{f_{OSC} \times L} \times \left(1 - \frac{V_{OUT}}{V_{IN}}\right) \times \left(R_{ESR} + \frac{1}{8 \times f_{OSC} \times C_{OUT}}\right)$$

Where L is the inductor value, C_{OUT} is the output capacitance value, and R_{ESR} is the equivalent series resistance (ESR) value of the output capacitor.

In the case of ceramic capacitors, the impedance at the switching frequency is dominated by the capacitance. The output voltage ripple is mainly caused by the capacitance. For simplification, the output voltage ripple can be estimated by:

$$\Delta V_{OUT} = \frac{V_{OUT}}{8 \times f_{OSC}^2 \times L \times C_{OUT}} \times \left(1 - \frac{V_{OUT}}{V_{IN}}\right)$$

In the case of tantalum or electrolytic capacitors, the ESR dominates the impedance at the switching frequency. For simplification, the output ripple can be approximated to:

$$\Delta V_{OUT} = \frac{V_{OUT}}{f_{OSC} \times L} \times \left(1 - \frac{V_{OUT}}{V_{IN}}\right) \times R_{ESR}$$

The characteristics of the output capacitor also affect the stability of the regulation system. The SGM6232 can be optimized for a wide range of capacitance and ESR values.

Compensation Components

SGM6232 employs current mode control for easy compensation and fast transient response. The system stability and transient response are controlled through the COMP pin. COMP pin is the output of the internal transconductance error amplifier. A serial capacitor and resistor combination sets a pole-zero combination to control the characteristics of the control system.

The DC gain of the voltage feedback loop is given by:

$$A_{VDC} = R_{LOAD} \times G_{CS} \times A_{EA} \times \frac{V_{FB}}{V_{OUT}}$$

Where A_{EA} is the error amplifier voltage gain, 10000V/V, G_{CS} is the current sense transconductance, 6.2A/V, and R_{LOAD} is the load resistor value.

The system has two poles of importance. One is due to the compensation capacitor ($C3$) and the output resistor of error amplifier, and the other is due to the output capacitor and the load resistor. These poles are located at:

$$f_{P1} = \frac{G_{EA}}{2\pi \times C3 \times A_{EA}} \quad f_{P2} = \frac{1}{2\pi \times C_{OUT} \times R_{LOAD}}$$

G_{EA} is the error amplifier transconductance, 800μA/V.

The system has one zero of importance, due to the compensation capacitor ($C3$) and the compensation resistor ($R3$). This zero is located at:

$$f_{Z1} = \frac{1}{2\pi \times C3 \times R3}$$

The system may have another zero of importance, if the output capacitor has a large capacitance and/or a high ESR value. The zero, due to the ESR and capacitance of the output capacitor, is located at:

$$f_{ESR} = \frac{1}{2\pi \times C_{OUT} \times R_{ESR}}$$

In this case, a third pole set by the compensation capacitor ($C6$) and the compensation resistor ($R3$) is used to compensate the effect of the ESR zero on the loop gain. This pole is located at:

$$f_{P3} = \frac{1}{2\pi \times C6 \times R3}$$

APPLICATION INFORMATION (continued)

The goal of compensation design is to shape the converter transfer function to get a desired loop gain. The system crossover frequency where the feedback loop has the unity gain is important.

Lower crossover frequencies result in slower line and load transient responses, while higher crossover frequencies could cause system unstable. A good rule of thumb is to set the crossover frequency to approximately one-thirtieth of the switching frequency. Switching frequency for the SGM6232 is 1.4MHz, so the desired crossover frequency is around 47kHz.

Table 2 lists the typical values of compensation components for some standard output voltages with various output capacitors and inductors. The values of the compensation components have been optimized for fast transient responses and good stability at given conditions.

Table 2. Compensation Values for Typical Output Voltage/Capacitor Combinations

V _{OUT} (V)	L (μH)	C _{OUT} (μF)	R3 (kΩ)	C3 (nF)	R1 (kΩ)	R2 (kΩ)
0.8	2.2	47/22×2	1.2	3.3	0	10.5
1.2	2.2	47/22×2	3	3.3	4.99	10
1.8	2.2	47/22×2	3.9	3.3	10.2	8.2
2.5	2.2 - 4.7	47/22×2	6.49	4.7	22.6	10.7
3.3	2.2 - 4.7	47/22×2	10	5.6	33	10.5
5	4.7 - 6.8	47/22×2	15	4.7	52.3	10
12	6.8 - 10	47/22×2	39	2.2	140	10

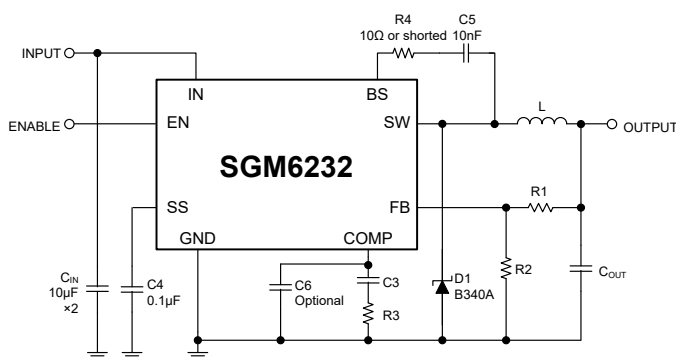

Figure 2. Typical Application Circuit

To optimize the compensation components for conditions not listed in Table2, the following procedure can be used.

1. Choose the compensation resistor (R3) to set the desired crossover frequency. Determine the R3 value by the following equation:

$$R3 = \frac{2\pi \times C_{OUT} \times f_C}{G_{EA} \times G_{CS}} \times \frac{V_{OUT}}{V_{FB}}$$

Where f_C is the desired crossover frequency (which typically has a value no higher than 47kHz).

2. Choose the compensation capacitor (C3) to achieve the desired phase margin. For applications with typical inductor values, setting the compensation zero, f_{z1} , below one-fourth of the crossover frequency provides sufficient phase margin.

Determine the C3 value by the following equation:

$$C3 > \frac{4}{2\pi \times R3 \times f_C}$$

Where, R3 is the compensation resistor value and f_C is the desired crossover frequency, 47kHz.

3. Determine if the second compensation capacitor (C6) is required. It is required if the ESR zero of the output capacitor is located at less than half of the 1.4MHz switching frequency, or the following relationship is valid:

$$\frac{1}{2\pi \times C_{OUT} \times R_{ESR}} < \frac{f_{OSC}}{2}$$

Where, C_{OUT} is the output capacitance value, R_{ESR} is the ESR value of the output capacitor, and f_{OSC} is the 1.4MHz switching frequency. If this is the case, then add the second compensation capacitor (C6) to set the pole f_{p3} at the location of the ESR zero. Determine the C6 value by the equation:

$$C6 = \frac{C_{OUT} \times R_{ESR}}{R3}$$

Where, C_{OUT} is the output capacitance value, R_{ESR} is the ESR value of the output capacitor, and R3 is the compensation resistor.

REVISION HISTORY

NOTE: Page numbers for previous revisions may differ from page numbers in the current version.

JULY 2015 – REV.A.1 to REV.A.2

Change Typical Application and input capacitor..... 1, 8

JULY 2014 – REV.A to REV.A.1

Add a 10Ω resistor between SW and BS pin in Typical Application..... 1, 3, 10

Changes from Original (APRIL 2010) to REV.A

Changed from product preview to production data..... All

PACKAGE OUTLINE DIMENSIONS

SOIC-8 (Exposed Pad)

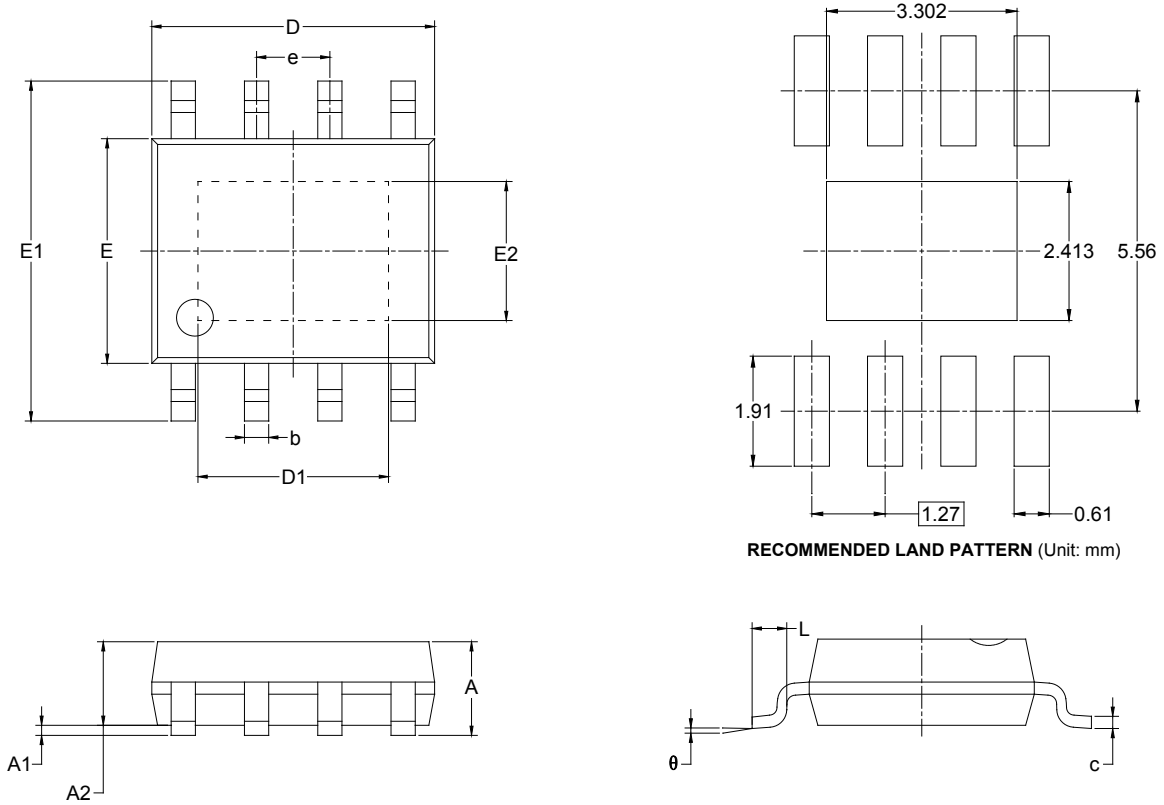

RECOMMENDED LAND PATTERN (Unit: mm)

Symbol	Dimensions In Millimeters		Dimensions In Inches	
	MIN	MAX	MIN	MAX
A		1.700		0.067
A1	0.000	0.100	0.000	0.004
A2	1.350	1.550	0.053	0.061
b	0.330	0.510	0.013	0.020
c	0.170	0.250	0.007	0.010
D	4.700	5.100	0.185	0.201
D1	3.202	3.402	0.126	0.134
E	3.800	4.000	0.150	0.157
E1	5.800	6.200	0.228	0.244
E2	2.313	2.513	0.091	0.099
e	1.27 BSC		0.050 BSC	
L	0.400	1.270	0.016	0.050
θ	0°	8°	0°	8°

PACKAGE INFORMATION

TAPE AND REEL INFORMATION

REEL DIMENSIONS



TAPE DIMENSIONS



NOTE: The picture is only for reference. Please make the object as the standard.

KEY PARAMETER LIST OF TAPE AND REEL

Package Type	Reel Diameter	Reel Width W1 (mm)	A0 (mm)	B0 (mm)	K0 (mm)	P0 (mm)	P1 (mm)	P2 (mm)	W (mm)	Pin1 Quadrant
SOIC-8 (Exposed Pad)	13"	12.4	6.40	5.40	2.10	4.0	8.0	2.0	12.0	Q1

000001

PACKAGE INFORMATION

CARTON BOX DIMENSIONS



NOTE: The picture is only for reference. Please make the object as the standard.

KEY PARAMETER LIST OF CARTON BOX

Reel Type	Length (mm)	Width (mm)	Height (mm)	Pizza/Carton
13"	386	280	370	5

DD0002