

GENERAL DESCRIPTION

The SGM6601 is a high-frequency Boost converter. The input voltage accepts a range of 1.8V to 5.5V. It is specified for small to medium LCD bias supply and white LED backlight supplies. The switching frequency can reach up to 1MHz, which supports both ceramic output capacitors and tantalum output capacitors.

The internal 400mA switch current limit provides a low output voltage ripple. For low-power applications, this device allows the use of a small form factor inductor. A typical low quiescent current of 20µA together with an optimized control scheme allows the device to achieve very high efficiency over the whole load current.

The adjustable output voltage can reach a maximum of 38V ideally with a dual-cell NiMH/NiCd battery or a single cell Li-Ion battery. And a standard 3.3V/5V to 12V power conversion can also be achieved.

The SGM6601 is available in TDFN-2x2-6L and TSOT-23-5 packages. It operates over an ambient temperature range of -40°C to +85°C.

FEATURES

- **Input Voltage Range: 1.8V to 5.5V**
- **38V (MAX) Adjustable Output Voltage**
- **400mA Internal Switch Current**
- **1MHz (MAX) Switching Frequency**
- **20µA (TYP) Low Quiescent Current**
- **0.1µA (TYP) Shutdown Current**
- **Internal Soft-Start Function**
- **-40°C to +85°C Operating Temperature Range**
- **Available in Green TSOT-23-5 and TDFN-2x2-6L Packages**

APPLICATIONS

- LCD Bias Supply
- White-LED Supply for LCD Backlights
- Mobile Phones
- Audio Player
- Digital Camera
- PDA's and Handheld PCs

TYPICAL APPLICATION

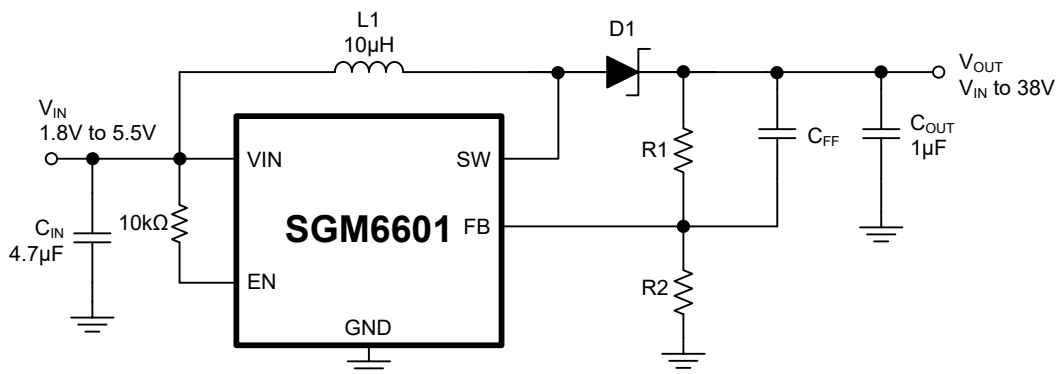

Figure 1. Typical Application Circuit

PACKAGE/ORDERING INFORMATION

MODEL	PACKAGE DESCRIPTION	SPECIFIED TEMPERATURE RANGE	ORDERING NUMBER	PACKAGE MARKING	PACKING OPTION
SGM6601	TDFN-2x2-6L	-40°C to +85°C	SGM6601YTDI6G/TR	6601 XXXX	Tape and Reel, 3000
	TSOT-23-5	-40°C to +85°C	SGM6601YTN5G/TR	SG4XX	Tape and Reel, 3000

MARKING INFORMATION

NOTE: **XXXX** = Date Code. **XX** = Date Code

TDFN-2x2-6L

XXXX

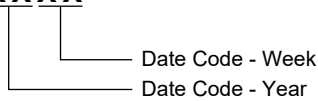

TSOT-23-5

YYY X X

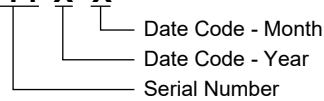

Green (RoHS & HSF): SG Micro Corp defines "Green" to mean Pb-Free (RoHS compatible) and free of halogen substances. If you have additional comments or questions, please contact your SGMICRO representative directly.

ABSOLUTE MAXIMUM RATINGS

Input Supply Voltage.....	-0.3V to 6V
EN and FB Pin Voltages.....	-0.3V to V_{IN}
SW Switch Voltage.....	40V
Operating Temperature Range.....	-40°C to +85°C
Junction Temperature.....	150°C
Storage Temperature Range.....	-65°C to +150°C
Package Thermal Resistance	
TDFN-2x2-6L, θ_{JA}	124°C/W
TSOT-23-5, θ_{JA}	250°C/W
Lead Temperature (Soldering, 10s).....	260°C
ESD Susceptibility	
HBM.....	4000V
MM.....	200V

OVERSTRESS CAUTION

Stresses beyond those listed in Absolute Maximum Ratings may cause permanent damage to the device. Exposure to absolute maximum rating conditions for extended periods may affect reliability. Functional operation of the device at any conditions beyond those indicated in the Recommended Operating Conditions section is not implied.

ESD SENSITIVITY CAUTION

This integrated circuit can be damaged if ESD protections are not considered carefully. SGMICRO recommends that all integrated circuits be handled with appropriate precautions. Failure to observe proper handling and installation procedures can cause damage. ESD damage can range from subtle performance degradation to complete device failure. Precision integrated circuits may be more susceptible to damage because even small parametric changes could cause the device not to meet the published specifications.

DISCLAIMER

SG Micro Corp reserves the right to make any change in circuit design, or specifications without prior notice.

PIN CONFIGURATION

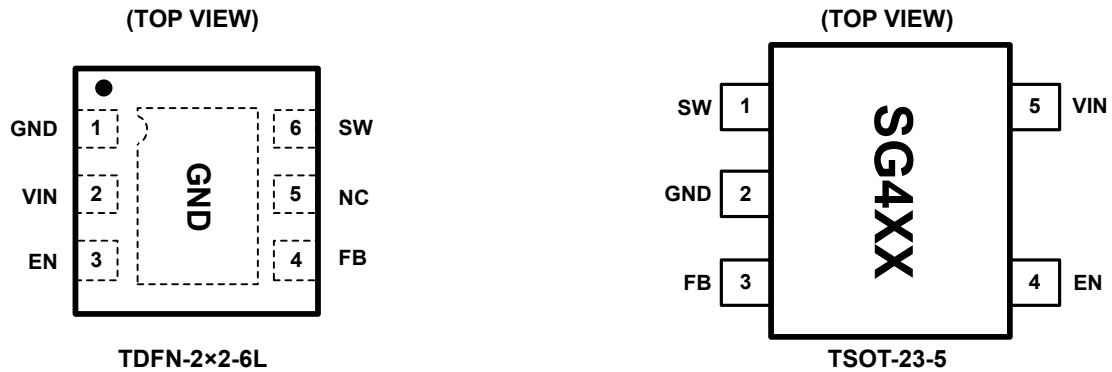

PIN DESCRIPTION

NAME	PIN		FUNCTION
	TDFN-2x2-6L	TSOT-23-5	
SW	6	1	Switch Pin. Connect to the drain of the internal power MOSFET. Connect this pin to the inductor and Schottky diode.
GND	1	2	Ground.
FB	4	3	Feedback Pin. An external voltage divider is used to set the desired output voltage.
EN	3	4	Enable Pin. Connect this pin to ground to make the device enter shutdown mode. Do not leave it floating.
VIN	2	5	Power Supply. Place it closely decoupled to GND with a capacitor.
NC	5	—	No Connection.
Exposed Pad	GND	—	Power Ground Exposed Pad. Must be connected to GND.

ELECTRICAL CHARACTERISTICS

($V_{IN} = 2.4V$, $EN = V_{IN}$, $C_{IN} = 4.7\mu F$, $C_{OUT} = 1\mu F$, $L = 10\mu H$, $T_A = -40^\circ C$ to $+85^\circ C$. Typical values are at $T_A = +25^\circ C$, unless otherwise noted.)

PARAMETER	SYMBOL	CONDITIONS	MIN	TYP	MAX	UNITS
SUPPLY CURRENT						
Input Voltage Range	V_{IN}		1.8		5.5	V
Shutdown Current	I_{SD}	$EN = GND$		0.1	1	μA
Operating Quiescent Current	I_Q	$I_{OUT} = 0mA$, not switching, $V_{FB} = 1.3V$		20	35	μA
Under-Voltage Lockout Threshold	V_{UVLO}			1.5	1.65	V
ENABLE						
EN Input High Voltage	V_{IH}		1.3			V
EN Input Low Voltage	V_{IL}				0.4	V
EN Input Leakage Current		$EN = GND$ or V_{IN}		0.1	1	μA
POWER SWITCH AND CURRENT LIMIT						
Maximum Switch Voltage	V_{SW}				39	V
Minimum Off-Time	t_{OFF}		270	430	570	ns
Maximum On-Time	t_{ON}		4	6	8.5	μs
MOSFET On-Resistance	$R_{DS(ON)}$	$V_{IN} = 2.4V$, $I_{SW} = 200mA$		660	1100	$m\Omega$
MOSFET Leakage Current		$V_{SW} = 38V$			1	μA
Switch Current Limit	I_{LIM}		210	400	500	mA
OUTPUT						
Adjustable Output Voltage Range	V_{OUT}		V_{IN}		38	V
Feedback Reference Voltage	V_{FB}	$T_A = +25^\circ C$	1.202	1.229	1.253	V
Feedback Leakage Current	I_{FB}	$V_{FB} = 1.3V$			1	μA
Output Voltage Line Regulation	ΔV_{OUT}	$V_{IN} = 1.8V$ to $5.5V$, $V_{OUT} = 18V$, $I_{LOAD} = 10mA$, $C_{FF} =$ not connected		0.04		%/V
Output Voltage Load Regulation		$V_{IN} = 2.4V$, $V_{OUT} = 18V$, $I_{OUT} = 0mA$ to $30mA$		0.15		%/mA

TYPICAL PERFORMANCE CHARACTERISTICS

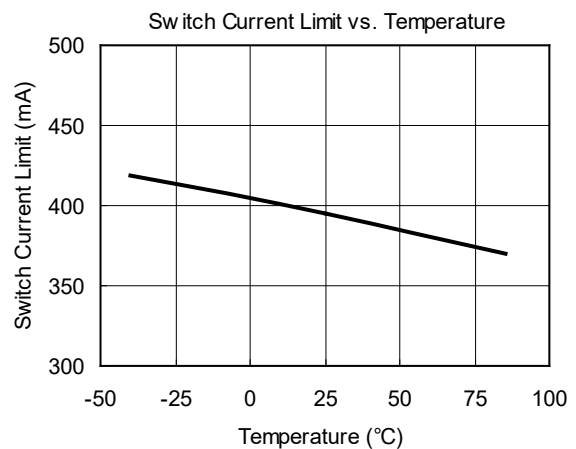
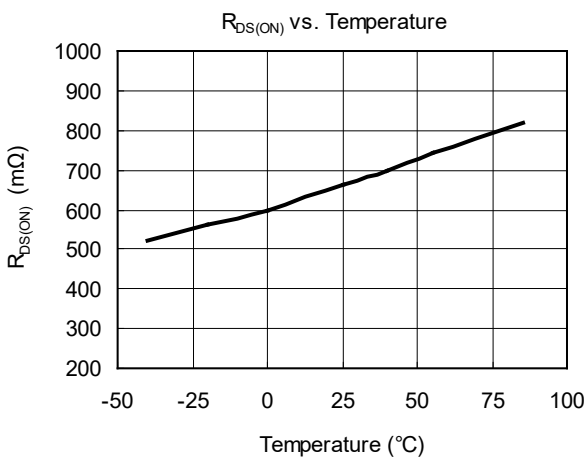
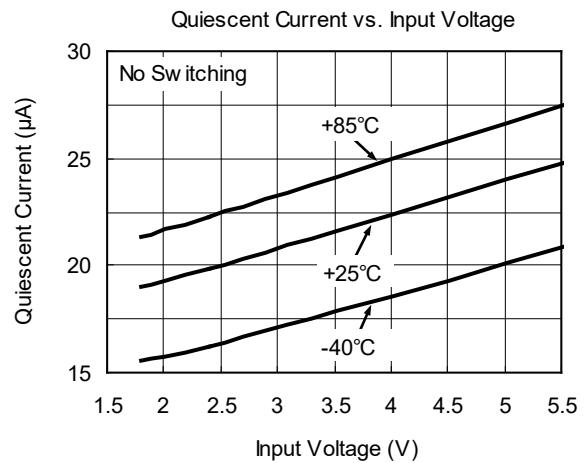
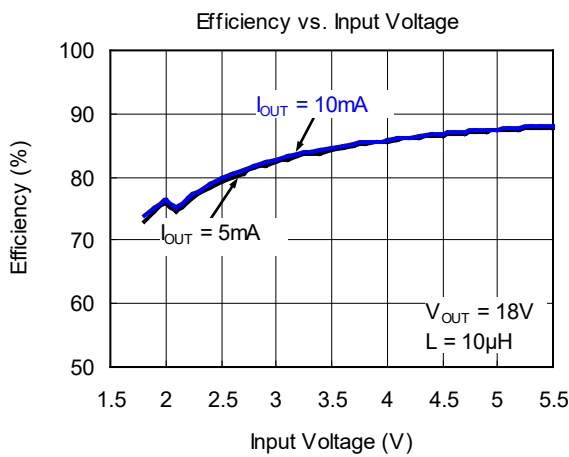
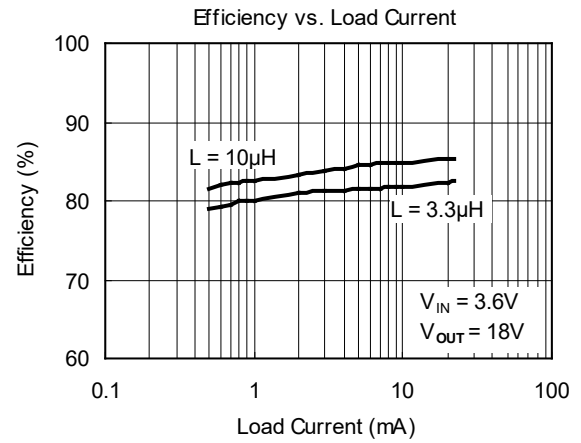
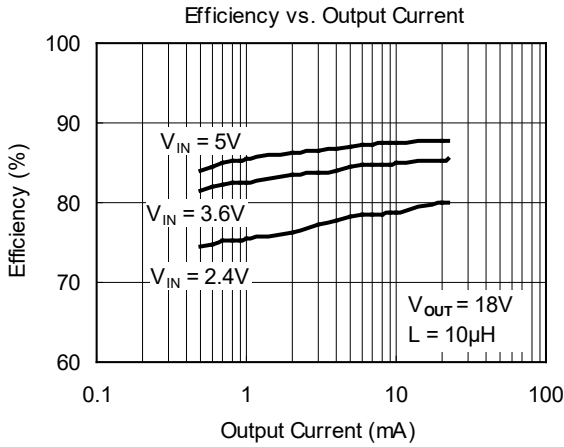

TYPICAL PERFORMANCE CHARACTERISTICS

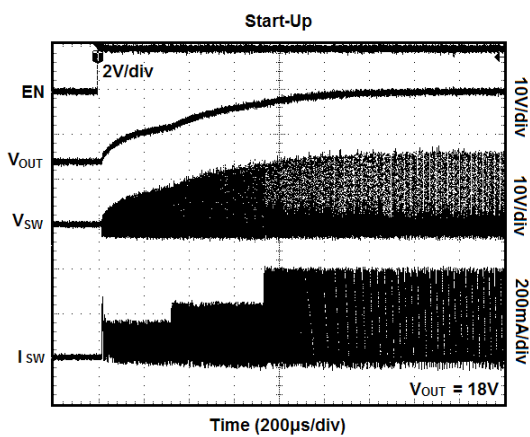
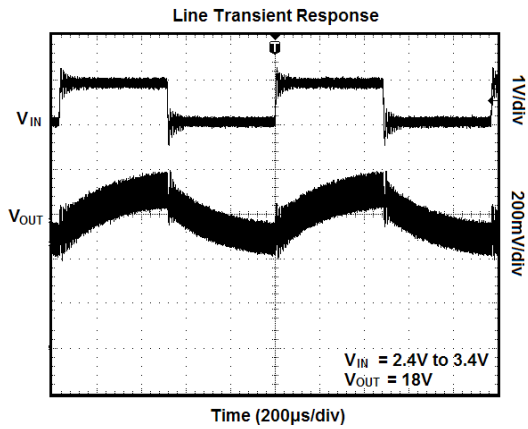
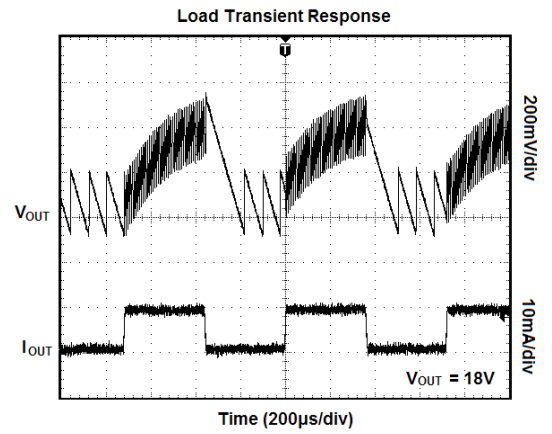
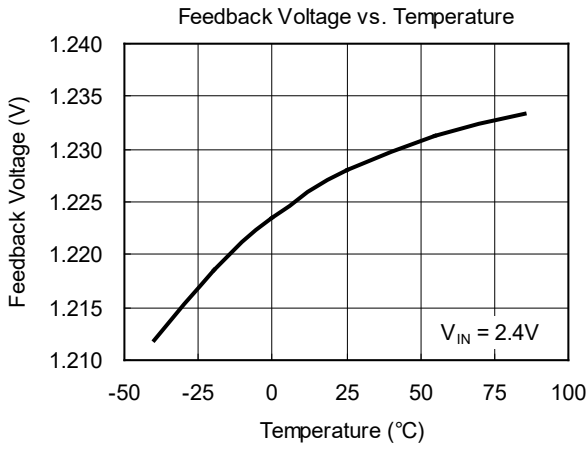

FUNCTIONAL BLOCK DIAGRAM

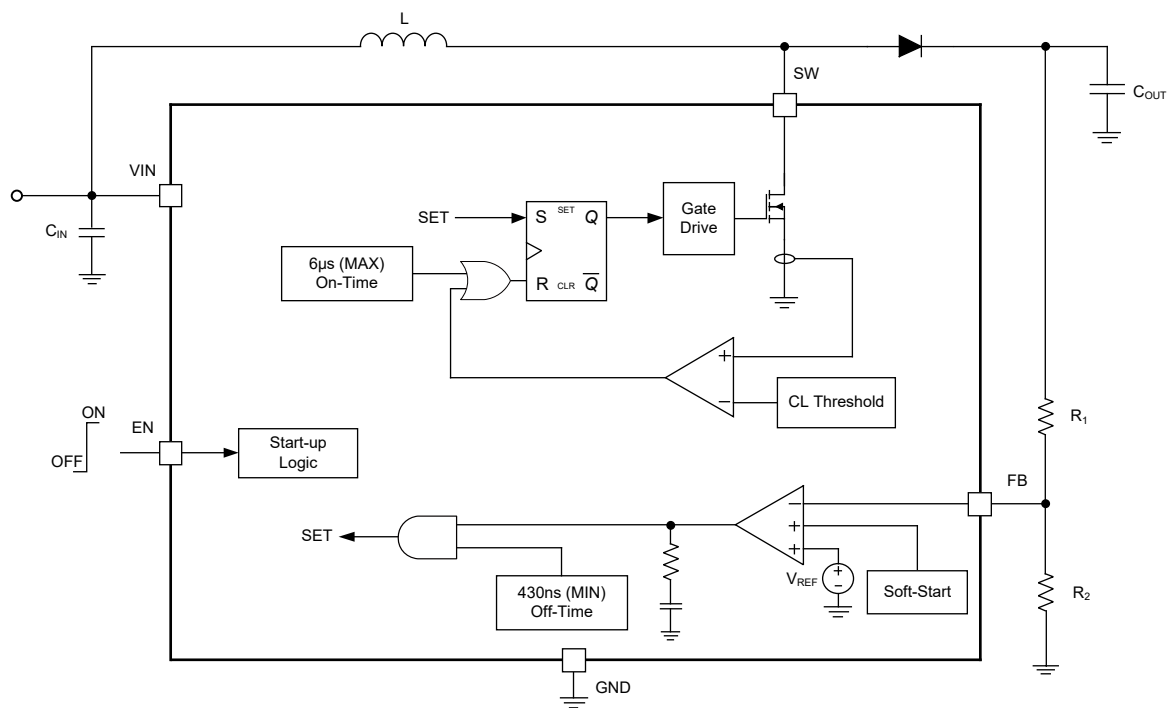

Figure 2. SGM6601 Block Diagram

DETAILED DESCRIPTION

Overview

The SGM6601 is a high voltage non-synchronous Boost converter and integrates a 400mA low-side power FET. It is capable of accepting output voltage up to 38V, and supports input voltage range from 1.8V to 5.5V. The SGM6601 implements the output voltage comparator and constant peak current limit architecture to regulate the output voltage. The SGM6601 operates with 1MHz nominal switching frequency which allows the use of small external components.

The internal error amplifier of SGM6601 constantly monitors the output voltage. As soon as the FB node voltage falls below the reference voltage, the low-side (LS) FET turns on to ramp up the inductor current until the 400mA (TYP) switch current is reached. For wide Boost ratio applications, an additional maximum on-time of 6μs (TYP) will terminate the LS FET on-time. After the LS FET turns off, the high-side rectifier is forward biased to deliver the inductor current to supply the load and replenish the output capacitor. There is a 430ns minimal off-time which dictates the LS FET off-time and the LS FET is triggered to turn on again once the feedback voltage drops below the reference voltage.

Peak Current Control

The SGM6601 turns off the LS FET when the inductor current reaches 400mA (TYP). The propagation delay of the current limit comparator contributes 100ns (TYP) of delay time during switching, and uses equation below to calculate the actual peak current.

$$I_{\text{PEAK(TYP)}} = I_{\text{LIM}} + \frac{V_{\text{IN}}}{L} \times 100\text{ns}$$

$$I_{\text{LIM}} = 400\text{mA}$$

Soft-Start

The SGM6601 integrates soft-start feature to reduce the inrush current during start-up. The device gradually increases the current limit threshold upon device enabling, the current limit is clamped at 1/3 of I_{LIM} (TYP) for 256 switching cycles, then released to 1/2 of I_{LIM} (TYP) for another 256 switching cycles, and lastly the full I_{LIM} (TYP).

Enable

The SGM6601 consumes 0.1μA (TYP) shutdown current when EN pin is pulled low. When the EN pin is low, the input voltage will bypass to the output via the high-side rectifier diode. Do not leave the EN pin floating.

Under-Voltage Lockout

The SGM6601 implements an input under-voltage lockout threshold of 1.5V. When the input voltage applied to VIN pin is below 1.5V, the device remains off.

Thermal Shutdown

A thermal shutdown function is implemented to prevent damage caused by excessive heat and power dissipation. Once the junction temperature of +155°C (TYP) is exceeded, the device is shut down. The device is released from shutdown automatically when the junction temperature decreases by 20°C.

APPLICATION INFORMATION

The SGM6601's output voltage regulation architecture is inherently stable, thus the inductance does not affect the stability of the device. The load current and conversion ratio affect the switching frequency of SGM6601. The recommended inductance of SGM6601 ranges from 2.2μH to 47μH. The selected inductance should ensure that the LS on-time does not exceed 6μs (TYP) maximum on-time, and the peak current of 400mA (TYP) should be reached within the 6μs for proper operation.

Equation below calculates the maximum switching frequency. The selected inductance determines the maximum switching frequency of SGM6601.

$$f_{S(MAX)} = \frac{V_{IN(MIN)} \times (V_{OUT} - V_{IN})}{I_p \times L \times V_{OUT}}$$

Where:

I_p = Peak current

L = Selected inductor value

$V_{IN(MIN)}$ = The highest switching frequency occurs at the minimum input voltage

If the above calculation does not exceed the maximum switching frequency, use equation below to calculate the actual switching frequency at the nominal load.

$$f_{S(ILOAD)} = \frac{2 \times I_{LOAD} \times (V_{OUT} - V_{IN} + V_d)}{I_p^2 \times L}$$

Where:

I_p = Peak current

L = Selected inductor value

I_{LOAD} = Nominal load current

V_d = Rectifier diode forward voltage (typically 0.3V)

Lower inductance results in higher switching frequency, but the efficiency is reduced with the increased switching frequency. Use equation below to calculate the maximum available load current once the inductance is selected.

$$I_{LOAD(MAX)} = \eta \frac{I_p^2 \times L \times f_{S(MAX)}}{2 \times (V_{OUT} - V_{IN})}$$

Where:

I_p = Peak current

L = Selected inductor value

$f_{S(MAX)}$ = Maximum switching frequency as calculated previously

η = Expected converter efficiency. Typically 70% to 85%

The position of operation point, the maximum load

current, is at where the converter begins to enter the continuous conduction mode. In general, the converter is supposed to operate in discontinuous conduction mode.

The selected inductor should have a saturation rating higher than the 400mA (TYP) peak current limit. The DC resistance of the selected inductor affects the conversion efficiency, and lower DC resistance results in higher efficiency.

Table 1. Recommended Inductor for Typical SGM6601 Applications

INDUCTOR	COMPONENT	COMMENTS
10μH	Sumida CR32-100	High efficiency
10μH	Sumida CDRH3D16-100	High efficiency
10μH	Murata LQH4C100K04	High efficiency
4.7μH	Sumida CDRH3D16-4R7	Small solution size
4.7μH	Murata LQH3C4R7M24	Small solution size

Output Voltage Setting

Connecting a resistive divider on the FB pin programs the output voltage of SGM6601. Use equation below to program the output voltage. R1 is the top feedback resistor and R2 is the bottom feedback resistor. The recommended value for R2 should be less than 200kΩ, and the maximum value for R1 should be less than 2.2MΩ.

$$V_{OUT} = 1.229V \times \left(1 + \frac{R1}{R2}\right)$$

A feedforward capacitor in parallel with R1 is recommended to improve the stability of SGM6601. Use equation below to calculate the required feedforward capacitance.

$$C_{FF} = \frac{1}{2 \times \pi \times \frac{f_s}{20} \times R1}$$

Where:

R1 = Upper resistor of voltage divider

f_s = Switching frequency of the converter at the nominal load current

C_{FF} = Choose the value closest to the calculated result

If there is no feedforward capacitor or the chosen value which is very low, the SGM6601 will appear double pulses or a pulse burst rather than a single pulse at the SW node, which results in higher output voltage ripple.

APPLICATION INFORMATION (continued)

Lower switching frequency requires larger feedforward capacitor, and larger feedforward capacitance results in poor line regulation. The selected feedforward capacitor should be as small as possible.

Line and Load Regulation

The SGM6601 requires a 45mV peak-to-peak voltage ripple on the FB pin to achieve good line regulation. For application with constraint on the total output capacitance, a feedforward capacitor is recommended to increase the voltage ripple coupled to the FB pin. It is recommended to use small inductor value to increase the switching frequency which will reduce the output voltage ripple, as well as the voltage ripple coupled to the feedback pin. In addition, a capacitor connected in parallel with the bottom feedback resistor can reduce the voltage ripple on the feedback pin down to 45mV, a starting point for this capacitor value could be the same as the chosen feedforward capacitor.

EN Pin Protection

Power input V_{IN} may exhibit very high voltage spike ($> 2 \times V_{IN}$) under certain situations such as hot swap or hot-insertion. In order to prevent SGM6601 from being damaged by high voltage spike and protect EN pin during power-on, when connecting EN to V_{IN} , a pull-up resistor ($> 1k\Omega$) is recommended to be added between EN and V_{IN} instead of connecting them directly (Figure 1).

Output Capacitor Selection

A low ESR ceramic capacitor is recommended to place at the SGM6601's output. Use equation below to estimate the output voltage ripple under normal operation.

$$\Delta V_{OUT} = \frac{I_{OUT}}{C_{OUT}} \times \left(\frac{1}{f_{S(IOUT)}} - \frac{I_p \times L}{V_{OUT} + V_d - V_{IN}} \right) + I_p \times ESR$$

where:

- I_p = Peak current
- L = Selected inductor value
- I_{OUT} = Nominal load current
- $f_{S(IOUT)}$ = Switching frequency at the nominal load current as calculated previously
- V_d = Rectifier diode forward voltage (typically 0.3 V)
- C_{OUT} = Selected output capacitor
- ESR = Output capacitor ESR value

Input Capacitor

Boost converter's input capacitor sees continuous

current throughout the entire switching cycle. A $4.7\mu F$ ceramic capacitor is recommended to place as close as possible between the VCC pin and GND pin of SGM6601. For the applications where the SGM6601 is located far away from the input source, a $47\mu F$ or higher capacitance capacitor is recommended to damp the wiring harness's inductance.

Schottky Diode Selection

The external rectification diode selection is critical to ensure device performance. A high speed and low forward voltage drop diode is recommended to improve efficiency. The average current rating of the diode should be higher than the peak load. The breakdown voltage of the selected diode should be higher than the programmed output voltage with margin, for example, a 12V output application requires a minimal of 20V breakdown voltage.

Layout Guidelines

In addition to component selection, layout is a critical step to ensure the performance of any switch mode power supplies. Poor layout can result in system instability, EMI failure, and device damage. Thus, place the inductor, input and output capacitors as close to the IC as possible. Wide and short traces can be used to minimize PCB inductance for current carrying traces.

For Boost converter, the output capacitor's current loop from V_{OUT} pin back to the GND pin of the device should be as small as possible.

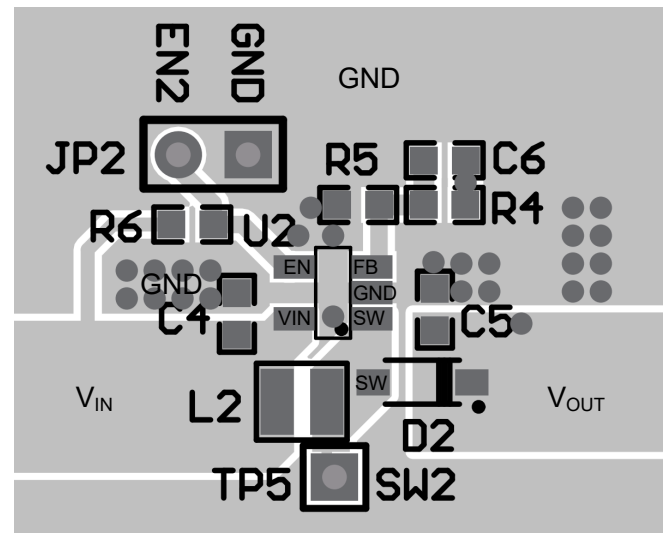

Figure 3. Layout Example

REVISION HISTORY

NOTE: Page numbers for previous revisions may differ from page numbers in the current version.

JUNE 2022 – REV.A.1 to REV.A.2	Page
Added Figure 2.....	7
Updated Detailed Description and Application Information sections.....	8, 9, 10
FEBRUARY 2014 – REV.A to REV.A.1	Page
Updated Electrical Characteristics data	4
Changes from Original (SEPTEMBER 2012) to REV.A	Page
Changed from product preview to production data.....	All

PACKAGE OUTLINE DIMENSIONS

TDFN-2x2-6L

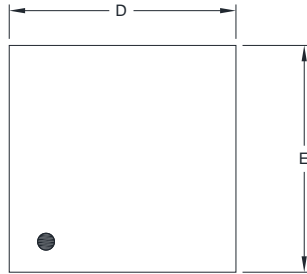

TOP VIEW

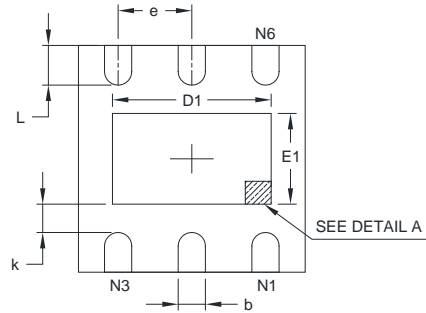

BOTTOM VIEW



SIDE VIEW

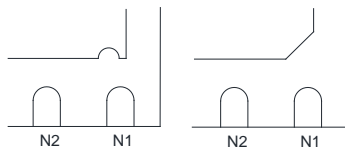

DETAIL A

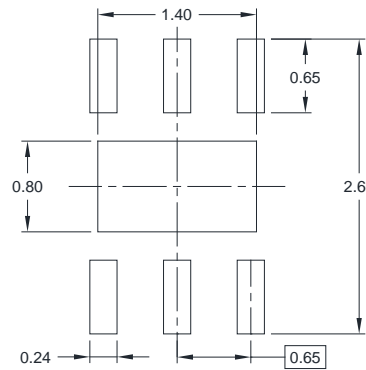

RECOMMENDED LAND PATTERN (Unit: mm)

Pin #1 ID and Tie Bar Mark Options

NOTE: The configuration of the Pin #1 identifier is optional, but must be located within the zone indicated.

Symbol	Dimensions In Millimeters		Dimensions In Inches	
	MIN	MAX	MIN	MAX
A	0.700	0.800	0.028	0.031
A1	0.000	0.050	0.000	0.002
A2	0.203 REF		0.008 REF	
D	1.900	2.100	0.075	0.083
D1	1.100	1.450	0.043	0.057
E	1.900	2.100	0.075	0.083
E1	0.600	0.850	0.024	0.034
k	0.200 MIN		0.008 MIN	
b	0.180	0.300	0.007	0.012
e	0.650 TYP		0.026 TYP	
L	0.250	0.450	0.010	0.018

NOTE: This drawing is subject to change without notice.

PACKAGE OUTLINE DIMENSIONS

TSOT-23-5

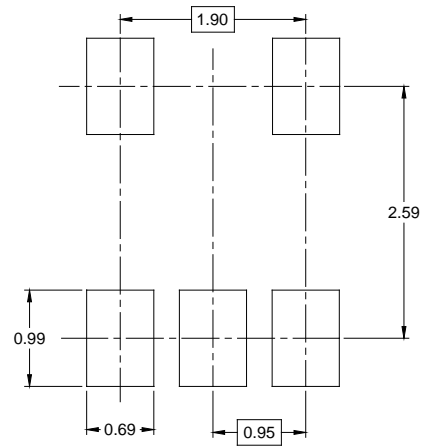
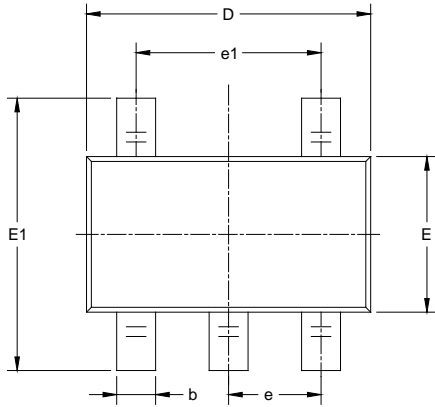

RECOMMENDED LAND PATTERN (Unit: mm)

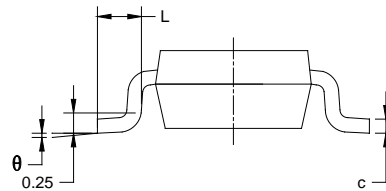
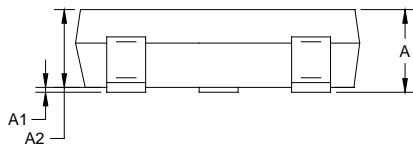

Symbol	Dimensions In Millimeters		Dimensions In Inches	
	MIN	MAX	MIN	MAX
A	0.700	0.900	0.028	0.035
A1	0.000	0.100	0.000	0.004
A2	0.700	0.800	0.028	0.031
b	0.350	0.500	0.014	0.020
c	0.080	0.200	0.003	0.008
D	2.820	3.020	0.111	0.119
E	1.600	1.700	0.063	0.067
E1	2.650	2.950	0.104	0.116
e	0.950 BSC		0.037 BSC	
e1	1.900 BSC		0.075 BSC	
L	0.300	0.600	0.012	0.024
θ	0°	8°	0°	8°

NOTES:

1. Body dimensions do not include mode flash or protrusion.
2. This drawing is subject to change without notice.

PACKAGE INFORMATION

TAPE AND REEL INFORMATION

REEL DIMENSIONS



TAPE DIMENSIONS



NOTE: The picture is only for reference. Please make the object as the standard.

KEY PARAMETER LIST OF TAPE AND REEL

Package Type	Reel Diameter	Reel Width W1 (mm)	A0 (mm)	B0 (mm)	K0 (mm)	P0 (mm)	P1 (mm)	P2 (mm)	W (mm)	Pin1 Quadrant
TDFN-2x2-6L	7"	9.50	2.30	2.30	1.10	4.00	4.00	2.00	8.00	Q1
TSOT-23-5	7"	9.5	3.17	3.1	1.10	4.0	4.0	2.0	8.0	Q3

DD0001

PACKAGE INFORMATION

CARTON BOX DIMENSIONS



NOTE: The picture is only for reference. Please make the object as the standard.

KEY PARAMETER LIST OF CARTON BOX

Reel Type	Length (mm)	Width (mm)	Height (mm)	Pizza/Carton
7" (Option)	368	227	224	8
7"	442	410	224	18

DD0002