

GENERAL DESCRIPTION

The SGM72108 is a single-pole/eight-throw (SP8T) antenna switch, which supports from 0.1GHz to 3.0GHz. The device features low insertion loss and high isolation, which make it suitable for high linearity receiving applications. It also has the advantage of high linearity performance. The SGM72108 is not subject to cellular interference and is applied to multi-mode and multi-band LTE mobile phones.

The SGM72108 has the ability to integrate SP8T RF switch and MIPI controller on silicon-on-insulator (SOI) process. Internal driver and decoder for switch control signals are offered by the controller, which makes it flexible in RF path band and routing selection.

No external DC blocking capacitors are required on the RF paths as long as no external DC voltage is applied, which can save PCB area and cost.

The SGM72108 is available in a Green UTQFN-2×2-14AL package.

APPLICATIONS

3G/4G Applications

FEATURES

- **Supply Voltage Range: 2.4V to 4.8V**
- **Advanced Silicon-On-Insulator (SOI) Process**
- **Frequency Range: 0.1GHz to 3.0GHz**
- **Low Insertion Loss: 0.65dB (TYP) at 2.7GHz**
- **MIPI RFFE Interface Compatible**
- **No External DC Blocking Capacitors Required**
- **Available in a Green UTQFN-2×2-14AL Package**

BLOCK DIAGRAM

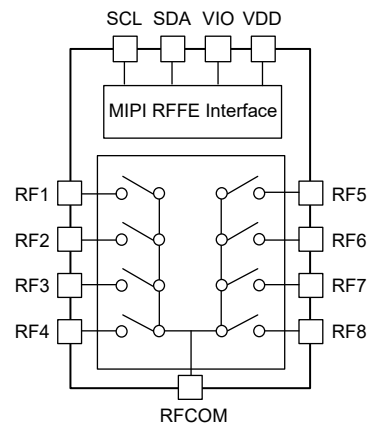

Figure 1. SGM72108 Block Diagram

PACKAGE/ORDERING INFORMATION

MODEL	PACKAGE DESCRIPTION	SPECIFIED TEMPERATURE RANGE	ORDERING NUMBER	PACKAGE MARKING	PACKING OPTION
SGM72108	UTQFN-2x2-14AL	-40°C to +85°C	SGM72108YURP14G/TR	RD6 XXXX	Tape and Reel, 3000

MARKING INFORMATION

NOTE: XXXX = Date Code and Trace Code.

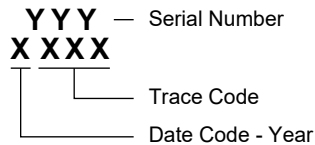

Green (RoHS & HSF): SG Micro Corp defines "Green" to mean Pb-Free (RoHS compatible) and free of halogen substances. If you have additional comments or questions, please contact your SGMICRO representative directly.

ABSOLUTE MAXIMUM RATINGS

- Supply Voltage, V_{DD}5V
- Supply Voltage for MIPI, V_{IO} 2V
- SDA, SCL Control Voltage, V_{CTL}2V
- RF Input Power, P_{IN}27dBm
- Junction Temperature.....+150°C
- Storage Temperature Range -55°C to +150°C
- Lead Temperature (Soldering, 10s).....+260°C
- ESD Susceptibility
- HBM..... 1000V

RECOMMENDED OPERATING CONDITIONS

- Operating Temperature Range -40°C to +85°C
- Operating Frequency Range..... 0.1GHz to 3.0GHz
- Supply Voltage, V_{DD}2.4V to 4.8V
- Supply Voltage for MIPI, V_{IO} 1.65V to 1.95V

OVERSTRESS CAUTION

Stresses beyond those listed in Absolute Maximum Ratings may cause permanent damage to the device. Exposure to absolute maximum rating conditions for extended periods may affect reliability. Functional operation of the device at any conditions beyond those indicated in the Recommended Operating Conditions section is not implied.

ESD SENSITIVITY CAUTION

This integrated circuit can be damaged if ESD protections are not considered carefully. SGMICRO recommends that all integrated circuits be handled with appropriate precautions. Failure to observe proper handling and installation procedures can cause damage. ESD damage can range from subtle performance degradation to complete device failure. Precision integrated circuits may be more susceptible to damage because even small parametric changes could cause the device not to meet the published specifications.

DISCLAIMER

SG Micro Corp reserves the right to make any change in circuit design, or specifications without prior notice.

PIN CONFIGURATION

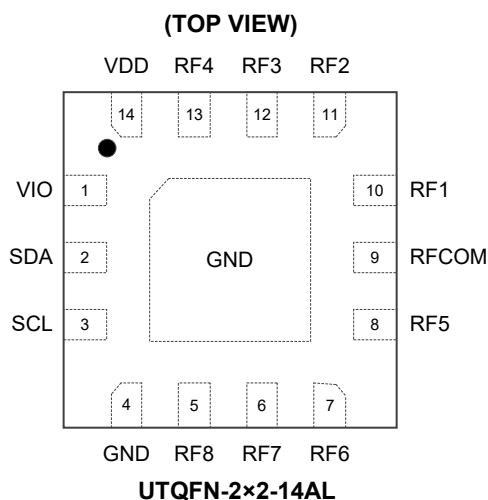

PIN DESCRIPTION

PIN	NAME	FUNCTION
1	VIO	Supply Voltage for MIPI.
2	SDA	RFFE Data Signal.
3	SCL	RFFE Clock Signal.
4	GND	Ground.
5	RF8	RF Port 8.
6	RF7	RF Port 7.
7	RF6	RF Port 6.
8	RF5	RF Port 5.
9	RFCOM	RF Common Port.
10	RF1	RF Port 1.
11	RF2	RF Port 2.
12	RF3	RF Port 3.
13	RF4	RF Port 4.
14	VDD	DC Power Supply.
Exposed Pad	GND	Ground.

Register_0 TRUTH TABLE

Table 1. Register_0 Truth Table

State	Mode	Register_0 Bits							
		D7	D6	D5	D4	D3	D2	D1	D0
1	Isolation	0	0	0	0	0	0	0	0
2	RF1	0	0	0	0	0	0	1	0
3	RF2	0	0	0	0	1	0	1	0
4	RF3	0	0	0	0	1	1	1	0
5	RF4	0	0	0	0	1	0	1	1
6	RF5	0	0	0	0	0	0	0	1
7	RF6	0	0	0	0	1	0	0	1
8	RF7	0	0	0	0	0	1	1	0
9	RF8	0	0	0	0	0	1	0	0

ELECTRICAL CHARACTERISTICS

(T_A = +25°C, V_{DD} = 2.4V to 4.8V, P_{IN} = 0dBm, 50Ω, typical values are at V_{DD} = 2.8V, unless otherwise noted.)

PARAMETER	SYMBOL	CONDITIONS	MIN	TYP	MAX	UNITS
DC Characteristics						
Supply Voltage	V _{DD}		2.4	2.8	4.8	V
Supply Current	I _{VDD}			32	60	μA
Supply Voltage for MIPI	V _{IO}		1.65	1.8	1.95	V
Supply Current for MIPI	I _{VIO}			4.8	10	μA
Control Voltage	V _{CTL_H}	High	0.8 × V _{IO}	V _{IO}	1.95	V
	V _{CTL_L}	Low	0		0.45	
Switching Time	t _{SW}	50% of control voltage to 90% of RF power		1	2	μs
Turn-On Time	t _{ON}	Time from V _{DD} = 0V to part on and RF at 90%		5	10	μs
RF Characteristics						
Insertion Loss (RFCOM to All RF Ports)	IL	f ₀ = 0.1GHz to 1.0GHz		0.42	0.60	dB
		f ₀ = 1.0GHz to 2.0GHz		0.55	0.70	
		f ₀ = 2.0GHz to 2.7GHz		0.65	0.90	
Isolation (RFCOM to All RF Ports)	ISO	f ₀ = 0.1GHz to 1.0GHz	25	42		dB
		f ₀ = 1.0GHz to 2.0GHz	22	34		
		f ₀ = 2.0GHz to 2.7GHz	18	30		
Input Return Loss (RFCOM to All RF Ports)	RL	f ₀ = 0.1GHz to 1.0GHz		20		dB
		f ₀ = 1.0GHz to 2.0GHz		13		
		f ₀ = 2.0GHz to 2.7GHz		16		
0.1dB Compression Point (RFCOM to All RF Ports)	P _{0.1dB}	f ₀ = 0.1GHz to 3.0GHz		27		dBm

PACKAGE OUTLINE DIMENSIONS

UTQFN-2x2-14AL

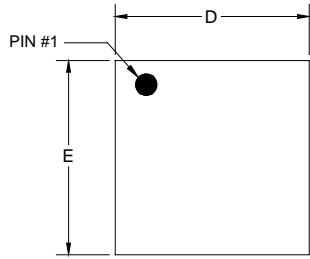

TOP VIEW

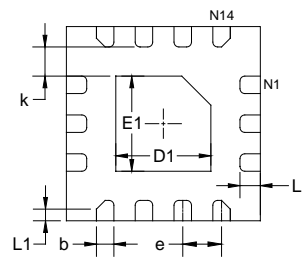

BOTTOM VIEW

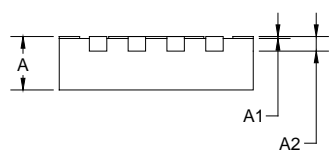

SIDE VIEW

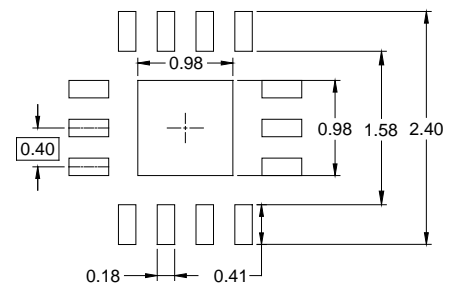

RECOMMENDED LAND PATTERN (Unit: mm)

Symbol	Dimensions In Millimeters		
	MIN	MOD	MAX
A	0.500	0.550	0.600
A1	0.000	0.020	0.050
A2	0.150 REF		
D	1.950	2.000	2.050
E	1.950	2.000	2.050
D1	0.880	0.980	1.080
E1	0.880	0.980	1.080
b	0.130	0.180	0.230
e	0.400 BSC		
k	0.150	-	-
L	0.160	0.210	0.260
L1	0.120 REF		

NOTE: This drawing is subject to change without notice.

PACKAGE INFORMATION

TAPE AND REEL INFORMATION

REEL DIMENSIONS



TAPE DIMENSIONS



NOTE: The picture is only for reference. Please make the object as the standard.

KEY PARAMETER LIST OF TAPE AND REEL

Package Type	Reel Diameter	Reel Width W1 (mm)	A0 (mm)	B0 (mm)	K0 (mm)	P0 (mm)	P1 (mm)	P2 (mm)	W (mm)	Pin1 Quadrant
UTQFN-2×2-14AL	7"	9.5	2.25	2.25	0.75	4.0	4.0	2.0	8.0	Q2

000001

PACKAGE INFORMATION

CARTON BOX DIMENSIONS



NOTE: The picture is only for reference. Please make the object as the standard.

KEY PARAMETER LIST OF CARTON BOX

Reel Type	Length (mm)	Width (mm)	Height (mm)	Pizza/Carton
7" (Option)	368	227	224	8
7"	442	410	224	18

DD0002