

### GENERAL DESCRIPTION

The SGM7SZ244 octal buffers/line drivers are designed specifically to improve both the performance and density of 3-state memory address drivers, clock drivers, and bus-oriented receivers and transmitters.

The SGM7SZ244 is organized as two 4-bit line drivers with separate output enable ( $\overline{nOE}$ ) inputs. When  $\overline{nOE}$  is low, the device passes non-inverting data from the  $nAn$  inputs to the  $nYn$  outputs. When  $\overline{nOE}$  is high, the outputs are in the high-impedance state.

The SGM7SZ244 is available in a Green TSSOP-20 package. It operates over an ambient temperature range of  $-40^{\circ}\text{C}$  to  $+125^{\circ}\text{C}$ .

### FEATURES

- **Wide Operating Voltage Range: 1.8V to 5.0V**
- **High-Current Outputs Drive Up to 15 LSTTL Loads**
- **3-State Outputs Drive Bus Lines or Buffer Memory Address Registers**
- **Low Power Consumption,  $I_{CC}$ : 25 $\mu\text{A}$  (MAX)**
- **Typical  $t_{PD}$  = 8.9ns at 5.0V**
- **$\pm 20\text{mA}$  Output Drive at 5.0V**
- **Low Input Current:  $\pm 8\mu\text{A}$  (MAX)**
- **$-40^{\circ}\text{C}$  to  $+125^{\circ}\text{C}$  Operating Temperature Range**
- **Available in a Green TSSOP-20 Package**

### LOGIC DIAGRAM

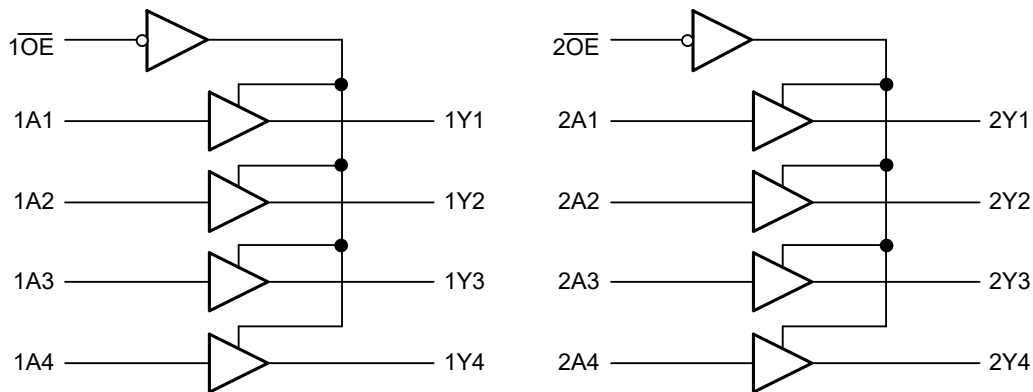

NOTE: Positive logic.

### FUNCTION TABLE

CONTROL INPUT	INPUT	OUTPUT
$\overline{nOE}$	$nAn$	$nYn$
L	H	H
L	L	L
H	X	Z

H = High Voltage Level

L = Low Voltage Level

Z = High-Impedance State

X = Don't Care

## SGM7SZ244

### PACKAGE/ORDERING INFORMATION

MODEL	PACKAGE DESCRIPTION	SPECIFIED TEMPERATURE RANGE	ORDERING NUMBER	PACKAGE MARKING	PACKING OPTION
SGM7SZ244	TSSOP-20	-40°C to +125°C	SGM7SZ244XTS20G/TR	SGM7SZ244XTS20 XXXXX	Tape and Reel, 4000

### MARKING INFORMATION

NOTE: XXXXX = Date Code and Vendor Code.

**XXXXX**

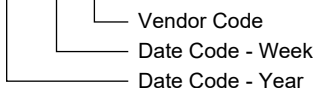

Green (RoHS & HSF): SG Micro Corp defines "Green" to mean Pb-Free (RoHS compatible) and free of halogen substances. If you have additional comments or questions, please contact your SGMICRO representative directly.

### ABSOLUTE MAXIMUM RATINGS <sup>(1)</sup>

Supply Voltage, $V_{CC}$ .....	-0.3V to 6.0V
Input Clamp Current, $I_{IK}$ <sup>(2)</sup>	
( $V_I < 0$ or $V_I > V_{CC}$ ).....	$\pm 20$ mA
Output Clamp Current, $I_{OK}$ <sup>(2)</sup>	
( $V_O < 0$ or $V_O > V_{CC}$ ).....	$\pm 20$ mA
Continuous Output Current, $I_O$ ( $V_O = 0V$ to $V_{CC}$ ).....	$\pm 40$ mA
Continuous Current through $V_{CC}$ or GND.....	$\pm 70$ mA
Junction Temperature <sup>(3)</sup> .....	+150°C
Storage Temperature Range.....	-65°C to +150°C
Lead Temperature (Soldering, 10s).....	+260°C
ESD Susceptibility	
HBM.....	6000V
CDM.....	1000V

### OVERSTRESS CAUTION

- Stresses beyond those listed in Absolute Maximum Ratings may cause permanent damage to the device. Exposure to absolute maximum rating conditions for extended periods may affect reliability. Functional operation of the device at any conditions beyond those indicated in the Recommended Operating Conditions section is not implied.
- The input and output negative voltage ratings may be exceeded if the input and output clamp current ratings are observed.
- The performance capability of a high-performance integrated circuit in conjunction with its thermal environment can create junction temperatures which are detrimental to reliability.

### DISCLAIMER

SG Micro Corp reserves the right to make any change in circuit design, or specifications without prior notice.

### RECOMMENDED OPERATING CONDITIONS <sup>(4)</sup>

Supply Voltage, $V_{CC}$ .....	1.8V to 5.0V
High-Level Input Voltage, $V_{IH}$	
( $V_{CC} = 1.8V$ ).....	1.2V (MIN)
( $V_{CC} = 3.3V$ ).....	1.75V (MIN)
( $V_{CC} = 5.0V$ ).....	2.2V (MIN)
Low-Level Input Voltage, $V_{IL}$	
( $V_{CC} = 1.8V$ ).....	0.4V (MAX)
( $V_{CC} = 3.3V$ ).....	0.65V (MAX)
( $V_{CC} = 5.0V$ ).....	0.65V (MAX)
Input Voltage, $V_I$ .....	0V to $V_{CC}$
Output Voltage, $V_O$ .....	0V to $V_{CC}$
Input Transition Rise or Fall Rate, $\Delta t/\Delta V$	
( $V_{CC} = 1.8V$ ).....	500ns (MAX)
( $V_{CC} = 3.3V$ ).....	250ns (MAX)
( $V_{CC} = 5.0V$ ).....	200ns (MAX)
Ambient Temperature Range.....	-40°C to +125°C

NOTE: 4. All unused inputs of the device must be held at  $V_{CC}$  or GND to ensure proper device operation.

### ESD SENSITIVITY CAUTION

This integrated circuit can be damaged if ESD protections are not considered carefully. SGMICRO recommends that all integrated circuits be handled with appropriate precautions. Failure to observe proper handling and installation procedures can cause damage. ESD damage can range from subtle performance degradation to complete device failure. Precision integrated circuits may be more susceptible to damage because even small parametric changes could cause the device not to meet the published specifications.

PIN CONFIGURATION

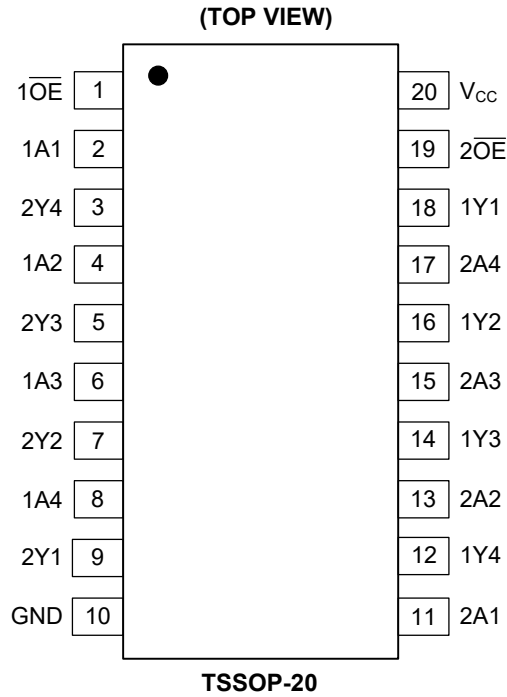

PIN DESCRIPTION

NAME	PIN	FUNCTION
$1\overline{OE}$ , $2\overline{OE}$	1, 19	Output Enable Inputs (Active Low).
1A1, 1A2, 1A3, 1A4	2, 4, 6, 8	Data Inputs.
2Y4, 2Y3, 2Y2, 2Y1	3, 5, 7, 9	Data Outputs.
GND	10	Ground.
2A1, 2A2, 2A3, 2A4	11, 13, 15, 17	Data Inputs.
1Y4, 1Y3, 1Y2, 1Y1	12, 14, 16, 18	Data Outputs.
$V_{CC}$	20	Supply Voltage.

## ELECTRICAL CHARACTERISTICS

(Full = -40°C to +125°C, typical values are at T<sub>A</sub> = +25°C, unless otherwise noted.)

PARAMETER	SYMBOL	CONDITIONS	TEMP	MIN	TYP	MAX	UNITS		
High-Level Output Voltage	V <sub>OH</sub>	V <sub>I</sub> = V <sub>IH</sub>	I <sub>OH</sub> = -20μA	V <sub>CC</sub> = 1.8V	Full	1.79	1.799	V	
				V <sub>CC</sub> = 3.3V	Full	3.29	3.299		
				V <sub>CC</sub> = 5.0V	Full	4.99	4.999		
			I <sub>OH</sub> = -6mA, V <sub>CC</sub> = 3.3V	Full	3.20	3.25			
			I <sub>OH</sub> = -7.8mA, V <sub>CC</sub> = 5.0V	Full	4.88	4.95			
Low-Level Output Voltage	V <sub>OL</sub>	V <sub>I</sub> = V <sub>IL</sub>	I <sub>OL</sub> = 20μA	V <sub>CC</sub> = 1.8V	Full		0.002	0.01	V
				V <sub>CC</sub> = 3.3V	Full		0.001	0.01	
				V <sub>CC</sub> = 5.0V	Full		0.001	0.01	
			I <sub>OL</sub> = 6mA, V <sub>CC</sub> = 3.3V	Full		0.06	0.15		
			I <sub>OL</sub> = 7.8mA, V <sub>CC</sub> = 5.0V	Full		0.07	0.15		
Input Leakage Current	I <sub>I</sub>	V <sub>CC</sub> = 5.0V, V <sub>I</sub> = V <sub>CC</sub> or 0V	Full		±0.01	8	μA		
Off-State Output Current	I <sub>OZ</sub>	V <sub>CC</sub> = 5.0V, V <sub>O</sub> = V <sub>CC</sub> or 0V	Full		±0.01	8	μA		
Supply Current	I <sub>CC</sub>	V <sub>CC</sub> = 5.0V, V <sub>I</sub> = V <sub>CC</sub> or 0V, I <sub>O</sub> = 0	Full		0.01	25	μA		
Power-Off Leakage Current	I <sub>OFF</sub>	V <sub>CC</sub> = 0V, V <sub>I</sub> or V <sub>O</sub> = 0V to 5.0V	Full		±0.01	10	μA		
Input Capacitance	C <sub>I</sub>	V <sub>CC</sub> = 1.8V to 5.0V	+25°C		15.6		pF		

## SWITCHING CHARACTERISTICS

(Full = -40°C to +125°C, typical values are at T<sub>A</sub> = +25°C, unless otherwise noted.)

PARAMETER	FROM (INPUT)	TO (OUTPUT)	V <sub>CC</sub>	MIN	TYP	MAX	UNITS
<b>(C<sub>L</sub> = 50pF)</b>							
t <sub>PD</sub>	nAn	nYn	1.8V		26.7		ns
			3.3V		11.0		
			5.0V		8.9		
t <sub>EN</sub>	n $\overline{\text{OE}}$	nYn	1.8V		36.6		ns
			3.3V		13.6		
			5.0V		10.1		
t <sub>DIS</sub>	n $\overline{\text{OE}}$	nYn	1.8V		39.5		ns
			3.3V		43.4		
			5.0V		44.9		
<b>(C<sub>L</sub> = 150pF)</b>							
t <sub>PD</sub>	nAn	nYn	1.8V		31.8		ns
			3.3V		11.8		
			5.0V		8.3		
t <sub>EN</sub>	n $\overline{\text{OE}}$	nYn	1.8V		41.9		ns
			3.3V		16.8		
			5.0V		14.0		
t <sub>DIS</sub>	n $\overline{\text{OE}}$	nYn	1.8V		60		ns
			3.3V		62		
			5.0V		64.3		

**SWITCHING CHARACTERISTICS (continued)**(Full = -40°C to +125°C, typical values are at T<sub>A</sub> = +25°C, unless otherwise noted.)

PARAMETER	CONDITIONS		MIN	TYP	MAX	UNITS
Input/Output Capacitance (C <sub>IO</sub> )				10.8		pF
Output Rise and Fall Times (t <sub>r</sub> , t <sub>f</sub> )	C <sub>L</sub> = 15pF	V <sub>CC</sub> = 1.8V		17.0		ns
		V <sub>CC</sub> = 3.3V		11.9		
		V <sub>CC</sub> = 5.0V		9.9		
	C <sub>L</sub> = 30pF	V <sub>CC</sub> = 1.8V		17.6		
		V <sub>CC</sub> = 3.3V		11.4		
		V <sub>CC</sub> = 5.0V		9.6		
	C <sub>L</sub> = 50pF	V <sub>CC</sub> = 1.8V		18.2		
		V <sub>CC</sub> = 3.3V		10.8		
		V <sub>CC</sub> = 5.0V		9.4		
Power Dissipation Capacitance per Transceiver (C <sub>PD</sub> )	No load			63.3		pF

PARAMETER MEASUREMENT INFORMATION

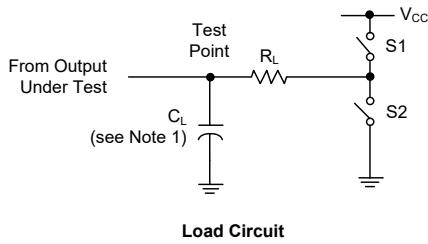

Parameter	$R_L$	$C_L$	S1	S2
$t_{EN}$	1k $\Omega$	50pF or 150pF	Open	Closed
			Closed	Open
$t_{DIS}$	1k $\Omega$	50pF	Open	Closed
			Closed	Open
$t_{PD}$ or $t_t$	-	50pF or 150pF	Open	Open

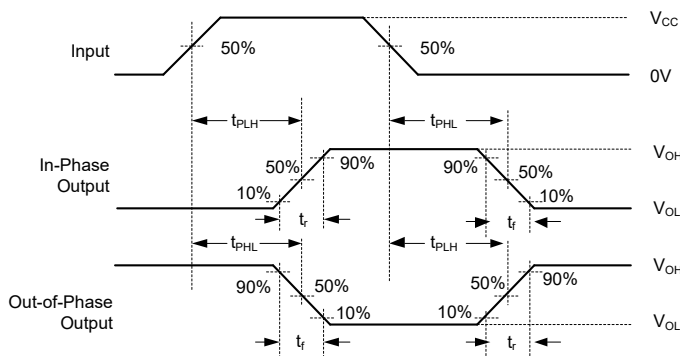

Voltage Waveforms  
Propagation Delay and Output Transition Times

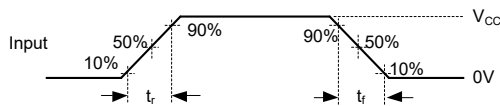

Voltage Waveforms  
Input Rise and Fall Times

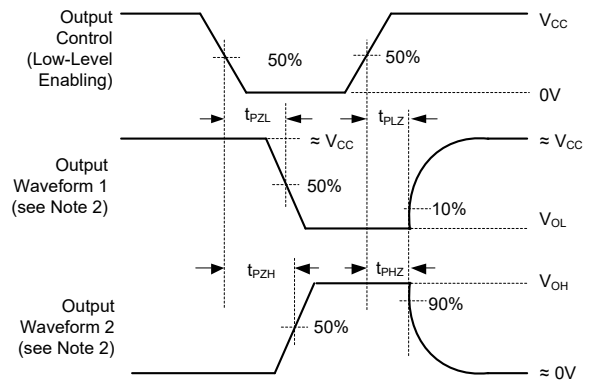

Voltage Waveforms  
Enable and Disable Times for 3-State Outputs

NOTES:

1.  $C_L$  includes probe and test-fixture capacitance.
2. Waveform 1 is for an output with internal conditions such that the output is low except when disabled by the output control. Waveform 2 is for an output with internal conditions such that the output is high except when disabled by the output control.
3. Phase relationships between waveforms were chosen arbitrarily. All input pulses are supplied by generators having the following characteristics:  $PRR \leq 1\text{MHz}$ ,  $Z_O = 50\Omega$ ,  $t_r = 6\text{ns}$ ,  $t_f = 6\text{ns}$ .
4. The outputs are measured one at a time with one input transition per measurement.
5.  $t_{PLZ}$  and  $t_{PHZ}$  are the same as  $t_{DIS}$ .
6.  $t_{PZL}$  and  $t_{PZH}$  are the same as  $t_{EN}$ .
7.  $t_{PLH}$  and  $t_{PHL}$  are the same as  $t_{PD}$ .

Figure 1. Load Circuit and Voltage Waveforms

**SGM7SZ244**

**REVISION HISTORY**

NOTE: Page numbers for previous revisions may differ from page numbers in the current version.

	<b>Page</b>
<hr/>	
<b>MARCH 2021 – REV.A.2 to REV.A.3</b>	
Updated Tape and Reel Information section .....	9
<hr/>	
<b>SEPTEMBER 2020 – REV.A.1 to REV.A.2</b>	<b>Page</b>
Updated TSSOP-20 package .....	8, 9
<hr/>	
<b>JUNE 2020 – REV.A to REV.A.1</b>	<b>Page</b>
Updated Electrical Characteristics section .....	1, 4
<hr/>	
<b>Changes from Original (APRIL 2020) to REV.A</b>	<b>Page</b>
Changed from product preview to production data .....	All
<hr/>	

PACKAGE OUTLINE DIMENSIONS

TSSOP-20

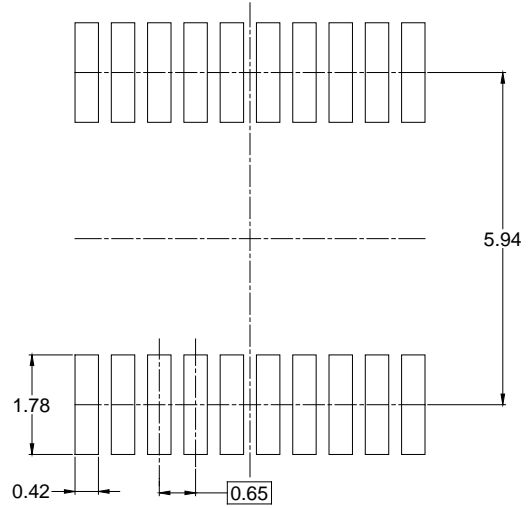
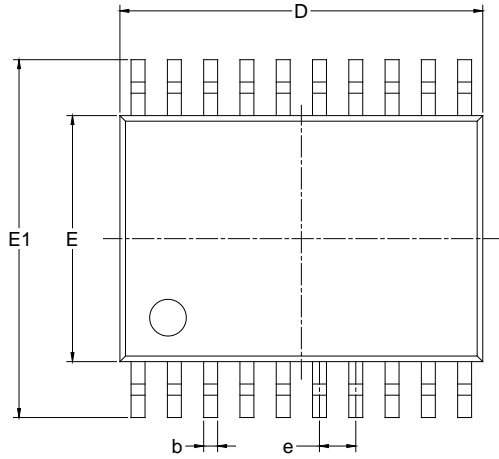

RECOMMENDED LAND PATTERN (Unit: mm)

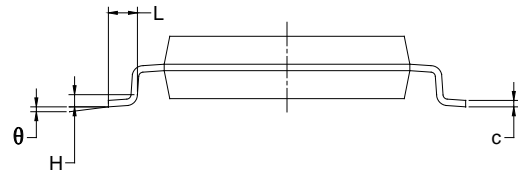
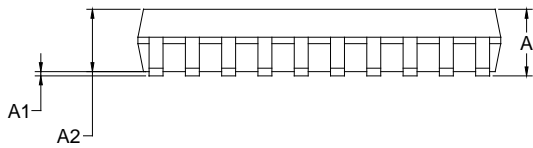

Symbol	Dimensions In Millimeters		
	MIN	MOD	MAX
A		-	1.200
A1	0.050	-	0.150
A2	0.800	-	1.050
b	0.190	-	0.300
c	0.090	-	0.200
D	6.400	-	6.600
E	4.300	-	4.500
E1	6.250	-	6.550
e	0.650 BSC		
L	0.450	-	0.750
H	0.250 TYP		
$\theta$	0°	-	8°

NOTES:

1. Body dimensions do not include mode flash or protrusion.
2. This drawing is subject to change without notice.



# PACKAGE INFORMATION

## TAPE AND REEL INFORMATION

### REEL DIMENSIONS



### TAPE DIMENSIONS

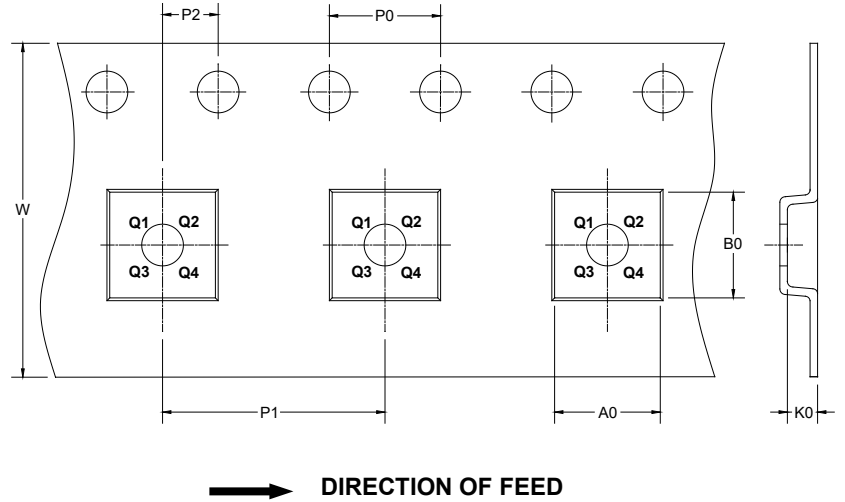

NOTE: The picture is only for reference. Please make the object as the standard.

### KEY PARAMETER LIST OF TAPE AND REEL

Package Type	Reel Diameter	Reel Width W1 (mm)	A0 (mm)	B0 (mm)	K0 (mm)	P0 (mm)	P1 (mm)	P2 (mm)	W (mm)	Pin1 Quadrant
TSSOP-20	13"	12.4	6.80	6.85	1.70	4.0	8.0	2.0	12.0	Q1

DD0001

# PACKAGE INFORMATION

## CARTON BOX DIMENSIONS



NOTE: The picture is only for reference. Please make the object as the standard.

## KEY PARAMETER LIST OF CARTON BOX

Reel Type	Length (mm)	Width (mm)	Height (mm)	Pizza/Carton
13"	386	280	370	5

DD0002