



# SGM8301/SGM8302/SGM8304 100MHz, High Voltage, Rail-to-Rail Output Amplifiers

## GENERAL DESCRIPTION

The SGM8301 (single), SGM8302 (dual) and SGM8304 (quad) are high speed operational amplifiers. These devices can operate from 4.5V to 12V single supply or from  $\pm 2.25V$  to  $\pm 6V$  dual supplies while consuming only 8.5mA quiescent current per amplifier. The SGM8301/2/4 provide wide input common mode voltage range and rail-to-rail output swing.

The SGM8301/2/4 have excellent video performance. They exhibit a -0.1dB gain flatness of 56MHz ( $G=+2$ ), a -3dB bandwidth of 100MHz, and a 155V/ $\mu s$  slew rate.

The SGM8301 is available in Green SOT-23-5, MSOP-8 and SOIC-8 packages. The SGM8302 is available in Green SOIC-8 and MSOP-8 packages. The SGM8304 is available in Green SOIC-14 and TSSOP-14 packages. They are specified over the extended -40°C to +85°C temperature range.

## FEATURES

- **Unity-Gain Stable**
- **High Speed:**
  - 3dB Bandwidth: 100MHz
  - Slew Rate: 155V/ $\mu s$
- **Excellent Video Performance:**
  - 0.1dB Gain Flatness: 56MHz
  - Diff Phase: 0.02°, Diff Gain: 0.02%
- **High Output Drive Capability: 103mA**
- **Rail-to-Rail Output**
- **Support Single or Dual Power Supplies:**
  - 4.5V to 12V or  $\pm 2.25V$  to  $\pm 6V$
- **-40°C to +85°C Operating Temperature Range**
- **Small Packaging:**
  - SGM8301 Available in Green SOT-23-5, SOIC-8 and MSOP-8 Packages
  - SGM8302 Available in Green MSOP-8 and SOIC-8 Packages
  - SGM8304 Available in Green SOIC-14 and TSSOP-14 Packages

## APPLICATIONS

Active Filters  
Video Line Driver  
Video-on-Demand  
Video Surveillance System  
ADC Interface  
CCD Imaging System  
Digital Camera  
Set-Top Box

**PACKAGE/ORDERING INFORMATION**

MODEL	PACKAGE DESCRIPTION	SPECIFIED TEMPERATURE RANGE	ORDERING NUMBER	PACKAGE MARKING	PACKING OPTION
SGM8301	SOT-23-5	-40°C to +85°C	SGM8301YN5G/TR	SA6XX	Tape and Reel, 3000
	SOIC-8	-40°C to +85°C	SGM8301YS8G/TR	SGM 8301YS8 XXXXX	Tape and Reel, 2500
	MSOP-8	-40°C to +85°C	SGM8301YMS8G/TR	SGM8301 YMS8 XXXXX	Tape and Reel, 3000
SGM8302	SOIC-8	-40°C to +85°C	SGM8302YS8G/TR	SGM 8302YS8 XXXXX	Tape and Reel, 2500
	MSOP-8	-40°C to +85°C	SGM8302YMS8G/TR	SGM8302 YMS8 XXXXX	Tape and Reel, 3000
SGM8304	SOIC-14	-40°C to +85°C	SGM8304YS14G/TR	SGM8304YS14 XXXXX	Tape and Reel, 2500
	TSSOP-14	-40°C to +85°C	SGM8304YTS14G/TR	SGM8304 YTS14 XXXXX	Tape and Reel, 3000

**MARKING INFORMATION**

NOTE: XX = Date Code. XXXXX = Date Code and Vendor Code.

**SOT-23-5**

**YYY X X**

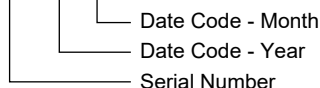

**SOIC-8/MSOP-8/SOIC-14/TSSOP-14**

**XXXXX**

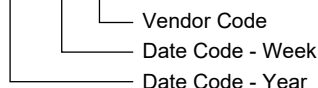

Green (RoHS & HSF): SG Micro Corp defines "Green" to mean Pb-Free (RoHS compatible) and free of halogen substances. If you have additional comments or questions, please contact your SGMICRO representative directly.

**ABSOLUTE MAXIMUM RATINGS**

Supply Voltage (+Vs to -Vs) .....	-0.3V to 13.2V
IN_+, IN_-, OUT_ .....	(-Vs) - 0.3V to (+Vs) + 0.3V
Differential Input Voltage .....	±2.5V
Package Thermal Resistance @ TA = +25°C	
SOT-23-5, θJA .....	232°C/W
SOIC-8, θJA .....	160°C/W
MSOP-8, θJA .....	216°C/W
SOIC-14, θJA .....	120°C/W
TSSOP-14, θJA .....	154°C/W
Junction Temperature .....	+150°C
Storage Temperature Range .....	-65°C to +150°C
Lead Temperature (Soldering, 10s) .....	+260°C
ESD Susceptibility	
HBM (SGM8301/4) .....	3000V
HBM (SGM8302) .....	2000V
MM .....	250V

**RECOMMENDED OPERATING CONDITIONS**

Operating Temperature Range .....	-40°C to +85°C
-----------------------------------	----------------

**OVERSTRESS CAUTION**

Stresses beyond those listed in Absolute Maximum Ratings may cause permanent damage to the device. Exposure to absolute maximum rating conditions for extended periods may affect reliability. Functional operation of the device at any conditions beyond those indicated in the Recommended Operating Conditions section is not implied.

**ESD SENSITIVITY CAUTION**

This integrated circuit can be damaged if ESD protections are not considered carefully. SGMICRO recommends that all integrated circuits be handled with appropriate precautions. Failure to observe proper handling and installation procedures can cause damage. ESD damage can range from subtle performance degradation to complete device failure. Precision integrated circuits may be more susceptible to damage because even small parametric changes could cause the device not to meet the published specifications.

**DISCLAIMER**

SG Micro Corp reserves the right to make any change in circuit design, or specifications without prior notice.

**PIN CONFIGURATIONS**

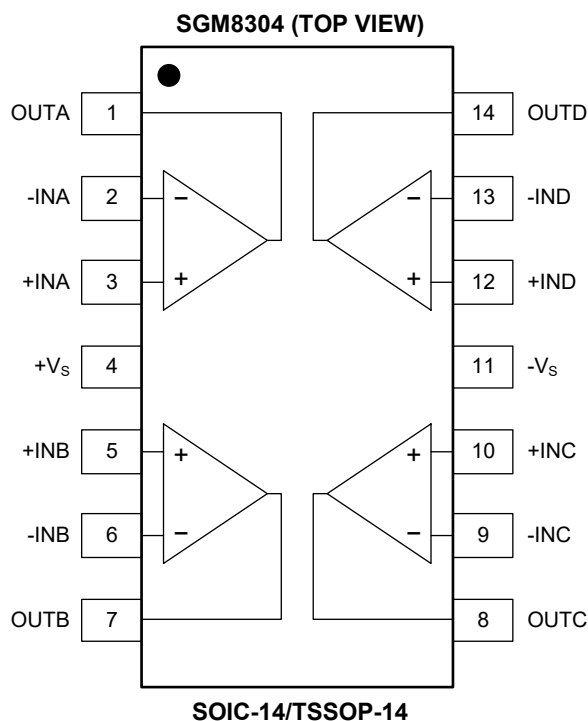
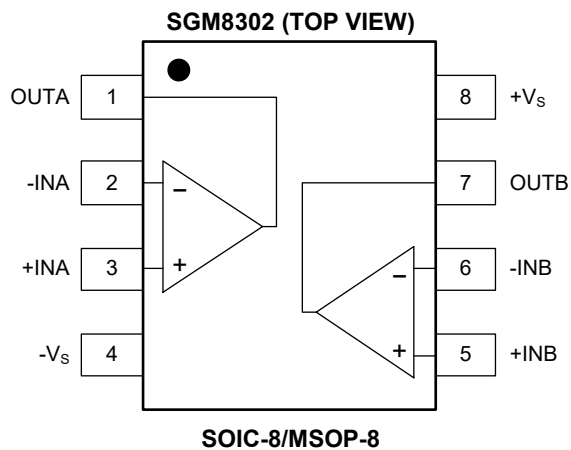
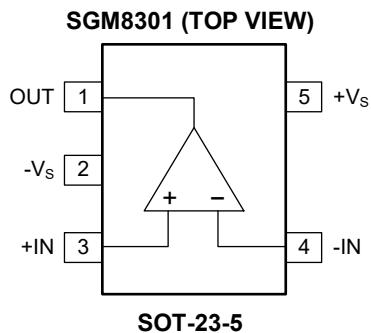
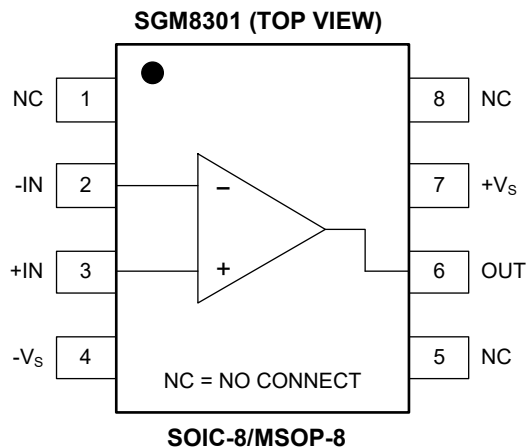

**ELECTRICAL CHARACTERISTICS**

( $V_S = 5V$ ,  $V_{CM} = V_S/2$ ,  $V_{OUT} = V_S/2$  and  $R_L = 100\Omega$  to  $V_S/2$ , typical values are at  $T_A = +25^\circ C$ , unless otherwise noted.)

PARAMETER	CONDITIONS	MIN	TYP	MAX	UNITS
<b>DC Performance</b>					
Quiescent Current/Amplifier ( $I_Q$ )	$I_{OUT} = 0mA$		7.5	10.2	mA
Input Offset Voltage ( $V_{OS}$ )		-18	5	18	mV
	$T_A = -40^\circ C$ to $+85^\circ C$	-21.5		21.5	
Input Offset Voltage Drift ( $\Delta V_{OS}/\Delta T$ )			12		$\mu V/^\circ C$
Open-Loop Gain ( $A_{OL}$ )	$R_L = 50\Omega$ , $1.3V \leq V_{OUT} \leq 3.7V$		88		dB
	$R_L = 150\Omega$ , $0.6V \leq V_{OUT} \leq 4.4V$	82	100		
	$R_L = 2k\Omega$ , $0.4V \leq V_{OUT} \leq 4.6V$	85	105		
Power Supply Rejection Ratio (PSRR)	$V_S = 4.5V$ to $13.2V$	65	80		dB
Common Mode Rejection Ratio (CMRR)	$V_{CM} = -0.1V$ to $2.75V$	58	75		dB
High Output Voltage Swing from Rail ( $V_{OH}$ )	$R_L = 2k\Omega$ to $V_S/2$		60	115	mV
	$R_L = 150\Omega$ to $V_S/2$		405	517	
	$R_L = 75\Omega$ to $V_S/2$		700		
	$R_L = 75\Omega$ to ground		1.515		V
Low Output Voltage Swing from Rail ( $V_{OL}$ )	$R_L = 2k\Omega$ to $V_S/2$		33	49.5	mV
	$R_L = 150\Omega$ to $V_S/2$		340	428	
	$R_L = 75\Omega$ to $V_S/2$		600		
	$R_L = 75\Omega$ to ground		3.2		
Output Current ( $I_{OUT}$ )	$R_L = 75\Omega$ to $V_S$ , sink	39.5	50		mA
	$R_L = 75\Omega$ to ground, source	37	47		
Output Short-Circuit Current ( $I_{SC}$ )	$R_L = 10\Omega$ to $V_S$ , sink		100		mA
	$R_L = 10\Omega$ to ground, source		75		
<b>AC Performance</b>					
Small-Signal -3dB Bandwidth ( $BW_{SS}$ )	$G = +1$		110		MHz
Large-Signal -3dB Bandwidth ( $BW_{LS}$ )	$G = +1$		51		
Small-Signal Bandwidth for -0.1dB Gain Flatness ( $BW_{0.1dBSS}$ )	$G = +1$		52		
Large-Signal Bandwidth for -0.1dB Gain Flatness ( $BW_{0.1dBS}$ )	$G = +1$		32		
Gain-Bandwidth Product (GBP)	$G = +100$		57		MHz
Phase Margin (PM)	$G = +100$		44		$^\circ$
Channel-to-Channel Crosstalk	$V_{IN} = 200mV_{P-P}$ , $f = 1kHz$		106		dB
Overload Recovery Time (ORT)	$f = 1kHz$		115		ns
Input Voltage Noise Density ( $e_n$ )	$f = 1kHz$		175		$nV/\sqrt{Hz}$
	$f = 10kHz$		65		
Slew Rate (SR) Up	$f = 1kHz$ , $2V_{P-P}$ output		115		$V/\mu s$
Slew Rate (SR) Down	$f = 1kHz$ , $2V_{P-P}$ output		140		$V/\mu s$
Settling Time to 0.1% ( $t_s$ )	$f = 1kHz$ , $2V_{P-P}$ output		65		ns
Rise/Fall Time ( $t_R/t_F$ )	$f = 1kHz$ , $V_{OUT} = 100mV_{P-P}$		7.8		ns
Differential Gain Error (DG)	NTSC		0.09		%
Differential Phase Error (DP)	NTSC		0.4		$^\circ$

**ELECTRICAL CHARACTERISTICS (continued)**

( $V_S = \pm 6V$ ,  $V_{CM} = 0V$ ,  $V_{OUT} = 0V$  and  $R_L = 100\Omega$  to ground, typical values are at  $T_A = +25^\circ C$ , unless otherwise noted.)

PARAMETER	CONDITIONS	MIN	TYP	MAX	UNITS
<b>DC Performance</b>					
Quiescent Current/Amplifier ( $I_Q$ )	$I_{OUT} = 0mA$		8.5	11.3	mA
Input Offset Voltage ( $V_{OS}$ )		-18	5	18	mV
	$T_A = -40^\circ C$ to $+85^\circ C$	-21.5		21.5	
Input Offset Voltage Drift ( $\Delta V_{OS}/\Delta T$ )			11		$\mu V/^\circ C$
Open-Loop Gain ( $A_{OL}$ )	$R_L = 150\Omega$ , $-4.5V \leq V_{OUT} \leq 4.5V$	85	94		dB
	$R_L = 2k\Omega$ , $-4.9V \leq V_{OUT} \leq 4.9V$	90	110		
Common Mode Rejection Ratio (CMRR)	$V_{CM} = -6.1V$ to $3.75V$	66	82		dB
High Output Voltage Swing from Rail ( $V_{OH}$ )	$R_L = 2k\Omega$ to ground		90	147	mV
	$R_L = 150\Omega$ to ground		760	956	
Low Output Voltage Swing from Rail ( $V_{OL}$ )	$R_L = 2k\Omega$ to ground		87	116	mV
	$R_L = 150\Omega$ to ground		888	1080	
Output Current ( $I_{OUT}$ )	$R_L = 75\Omega$ to $V_S$	71	103		mA
	$R_L = 75\Omega$ to $-V_S$	53	90		
<b>AC Performance</b>					
Small-Signal -3dB Bandwidth ( $BW_{SS}$ )	$G = +1$		100		MHz
Large-Signal -3dB Bandwidth ( $BW_{LS}$ )	$G = +1$		44		
Small-Signal Bandwidth for -0.1dB Gain Flatness ( $BW_{0.1dBSS}$ )	$G = +1$		56		
Large-Signal Bandwidth for -0.1dB Gain Flatness ( $BW_{0.1dBLS}$ )	$G = +1$		30		
Gain-Bandwidth Product (GBP)	$G = +100$		60		MHz
Phase Margin (PM)	$G = +100$		42		$^\circ$
Channel-to-Channel Crosstalk	$V_{IN} = 200mV_{P-P}$ , $f = 1kHz$		106		dB
Overload Recovery Time (ORT)	$f = 1kHz$		54		ns
Input Voltage Noise Density ( $e_n$ )	$f = 1kHz$		174		$nV/\sqrt{Hz}$
	$f = 10kHz$		65		
Slew Rate (SR) Up	$f = 1kHz$ , $2V_{P-P}$ output		145		$V/\mu s$
Slew Rate (SR) Down	$f = 1kHz$ , $2V_{P-P}$ output		155		$V/\mu s$
Settling Time to 0.1% ( $t_s$ )	$f = 1kHz$ , $2V_{P-P}$ output		84		ns
Rise/Fall Time ( $t_R/t_F$ )	$f = 1kHz$ , $V_{OUT} = 100mV_{P-P}$		7.5		ns
Differential Gain Error (DG)	NTSC		0.02		%
Differential Phase Error (DP)	NTSC		0.02		$^\circ$

**TYPICAL PERFORMANCE CHARACTERISTICS**

At  $T_A = +25^\circ\text{C}$ ,  $+V_S = 5\text{V}$ ,  $-V_S = -5\text{V}$ ,  $V_{CM} = 0\text{V}$  and  $R_L = 100\Omega$  to GND, unless otherwise noted.

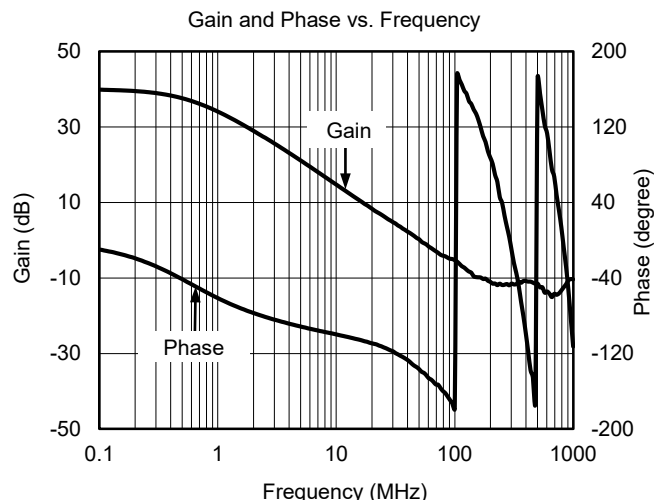
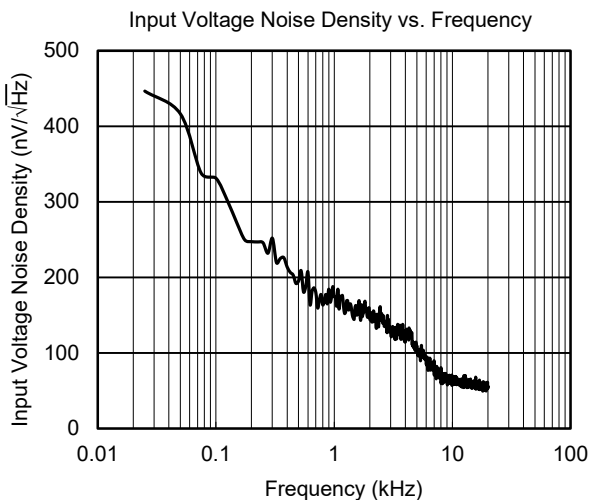
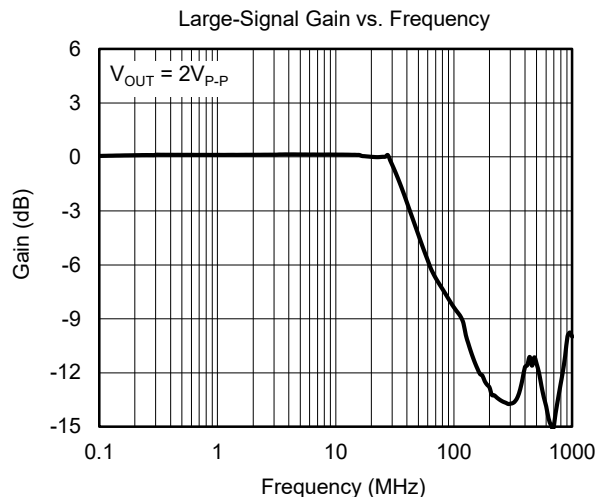
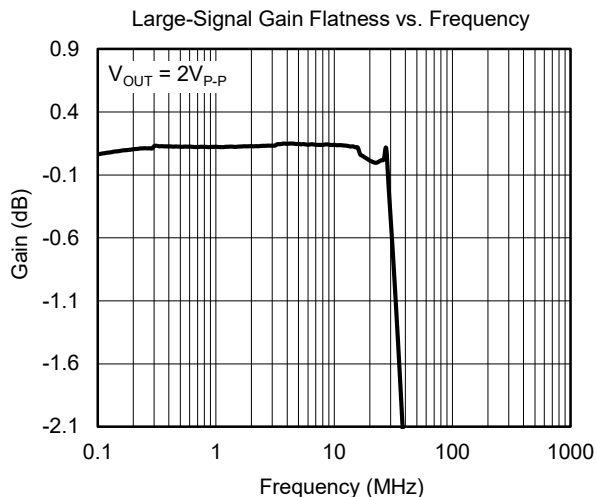
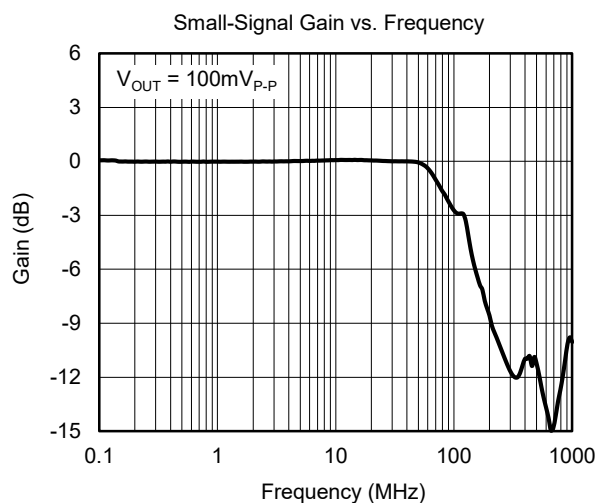
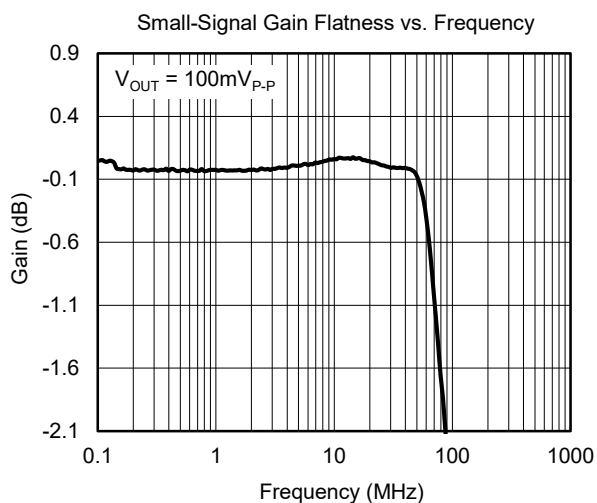

**TYPICAL PERFORMANCE CHARACTERISTICS (continued)**

At  $T_A = +25^\circ\text{C}$ ,  $+V_S = 5\text{V}$ ,  $-V_S = -5\text{V}$ ,  $V_{CM} = 0\text{V}$  and  $R_L = 100\Omega$  to GND, unless otherwise noted

Small-Signal Pulse Response

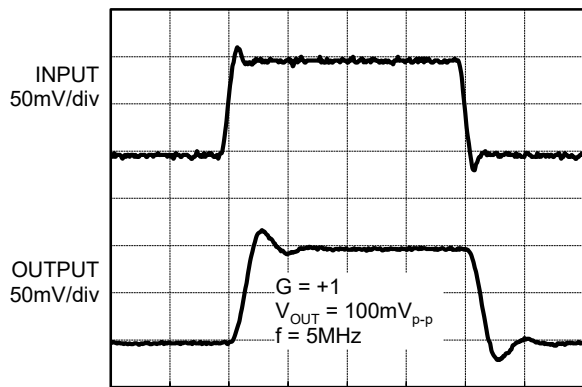

Time (25ns/div)

Large-Signal Pulse Response

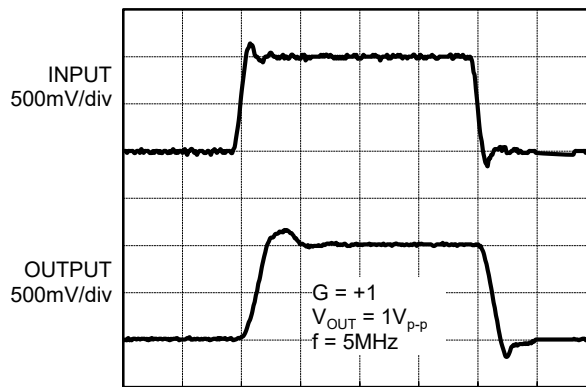

Time (25ns/div)

Small-Signal Pulse Response

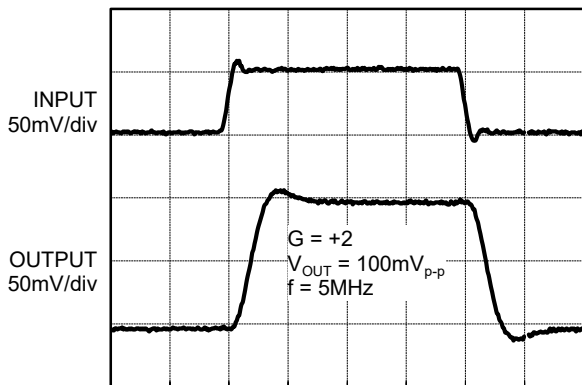

Time (25ns/div)

Large-Signal Pulse Response

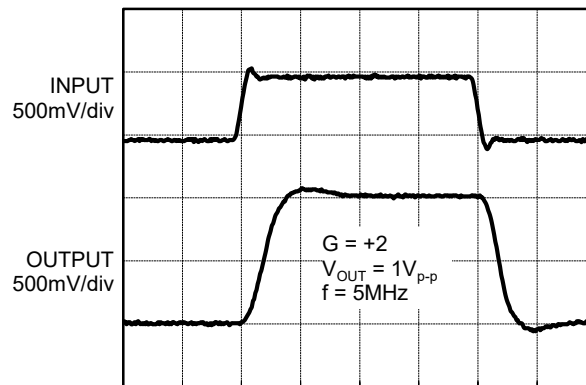

Time (25ns/div)

Small-Signal Pulse Response

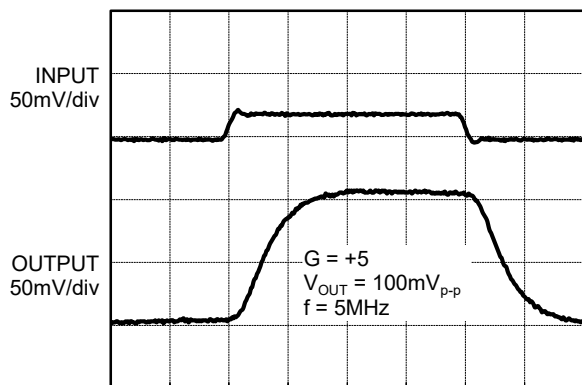

Time (25ns/div)

Large-Signal Pulse Response

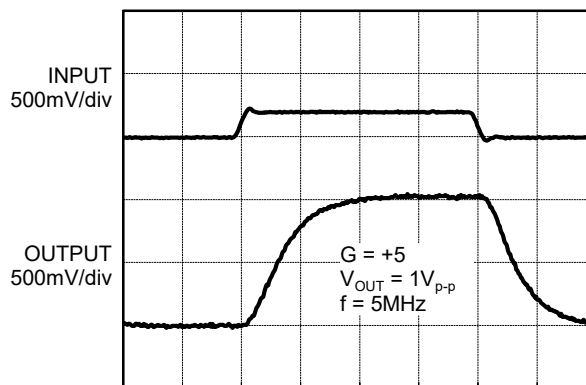

Time (25ns/div)



**TYPICAL PERFORMANCE CHARACTERISTICS (continued)**

At  $T_A = +25^\circ\text{C}$ ,  $+V_S = 5\text{V}$ ,  $-V_S = -5\text{V}$ ,  $V_{CM} = 0\text{V}$  and  $R_L = 100\Omega$  to GND, unless otherwise noted

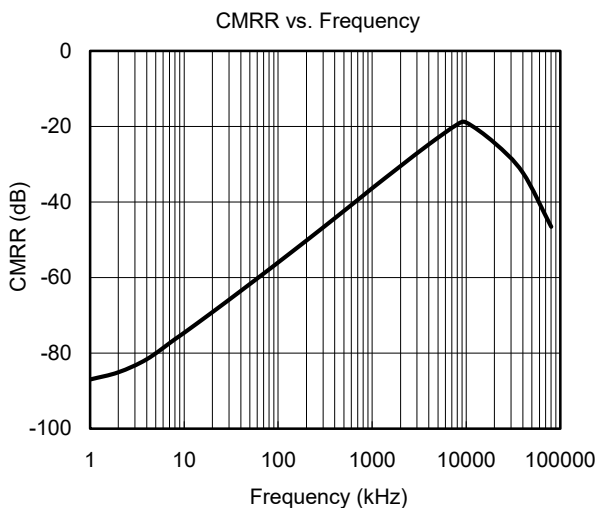
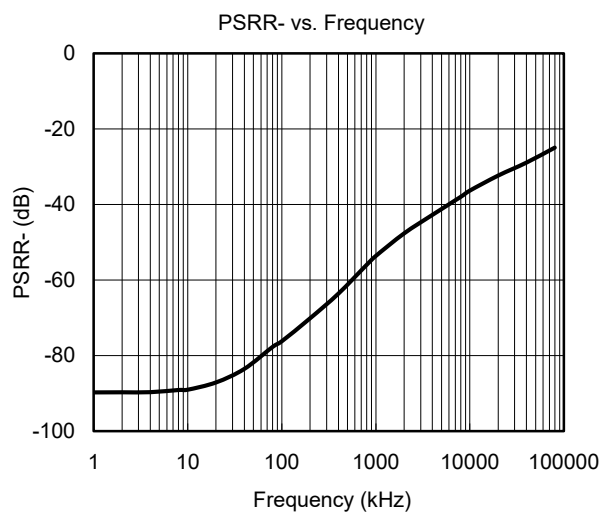
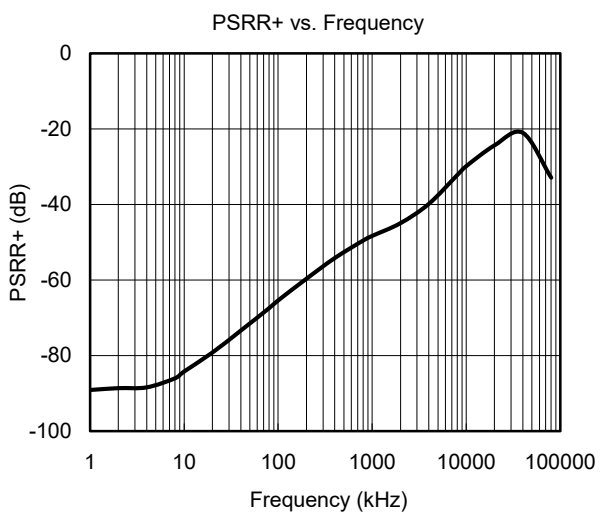

---

## **REVISION HISTORY**

NOTE: Page numbers for previous revisions may differ from page numbers in the current version.

	<b>Page</b>
<hr/>	
<b>JUNE 2017 – REV.A.2 to REV.A.3</b>	
Added Package Thermal Resistance .....	3
<hr/>	
<b>MAY 2013 – REV.A.1 to REV.A.2</b>	<b>Page</b>
Changed supply voltage range from 5V to 12V to 4.5V to 12V .....	1, 9
<hr/>	
<b>JANUARY 2013 – REV.A to REV.A.1</b>	<b>Page</b>
Added Tape and Reel Information section .....	15~16
<hr/>	
<b>Changes from Original (JULY 2012) to REV.A</b>	<b>Page</b>
Changed from product preview to production data .....	All
<hr/>	

PACKAGE OUTLINE DIMENSIONS

SOT-23-5



RECOMMENDED LAND PATTERN (Unit: mm)



Symbol	Dimensions In Millimeters		Dimensions In Inches	
	MIN	MAX	MIN	MAX
A	1.050	1.250	0.041	0.049
A1	0.000	0.100	0.000	0.004
A2	1.050	1.150	0.041	0.045
b	0.300	0.500	0.012	0.020
c	0.100	0.200	0.004	0.008
D	2.820	3.020	0.111	0.119
E	1.500	1.700	0.059	0.067
E1	2.650	2.950	0.104	0.116
e	0.950 BSC		0.037 BSC	
e1	1.900 BSC		0.075 BSC	
L	0.300	0.600	0.012	0.024
$\theta$	0°	8°	0°	8°

PACKAGE OUTLINE DIMENSIONS

SOIC-8

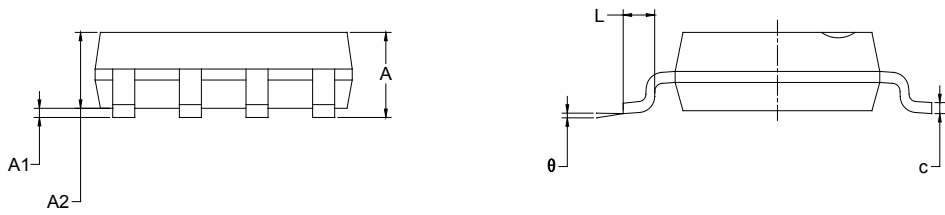
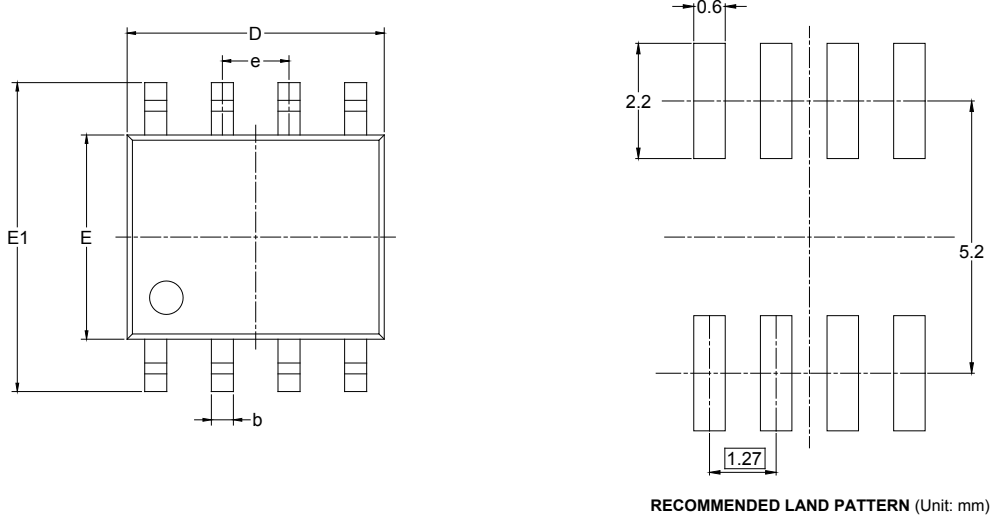

Symbol	Dimensions In Millimeters		Dimensions In Inches	
	MIN	MAX	MIN	MAX
A	1.350	1.750	0.053	0.069
A1	0.100	0.250	0.004	0.010
A2	1.350	1.550	0.053	0.061
b	0.330	0.510	0.013	0.020
c	0.170	0.250	0.006	0.010
D	4.700	5.100	0.185	0.200
E	3.800	4.000	0.150	0.157
E1	5.800	6.200	0.228	0.244
e	1.27 BSC		0.050 BSC	
L	0.400	1.270	0.016	0.050
θ	0°	8°	0°	8°

PACKAGE OUTLINE DIMENSIONS

MSOP-8



RECOMMENDED LAND PATTERN (Unit: mm)

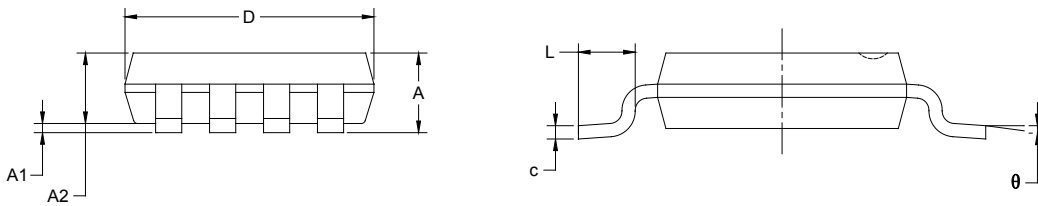

Symbol	Dimensions In Millimeters		Dimensions In Inches	
	MIN	MAX	MIN	MAX
A	0.820	1.100	0.032	0.043
A1	0.020	0.150	0.001	0.006
A2	0.750	0.950	0.030	0.037
b	0.250	0.380	0.010	0.015
c	0.090	0.230	0.004	0.009
D	2.900	3.100	0.114	0.122
E	2.900	3.100	0.114	0.122
E1	4.750	5.050	0.187	0.199
e	0.650 BSC		0.026 BSC	
L	0.400	0.800	0.016	0.031
θ	0°	6°	0°	6°

PACKAGE OUTLINE DIMENSIONS

SOIC-14

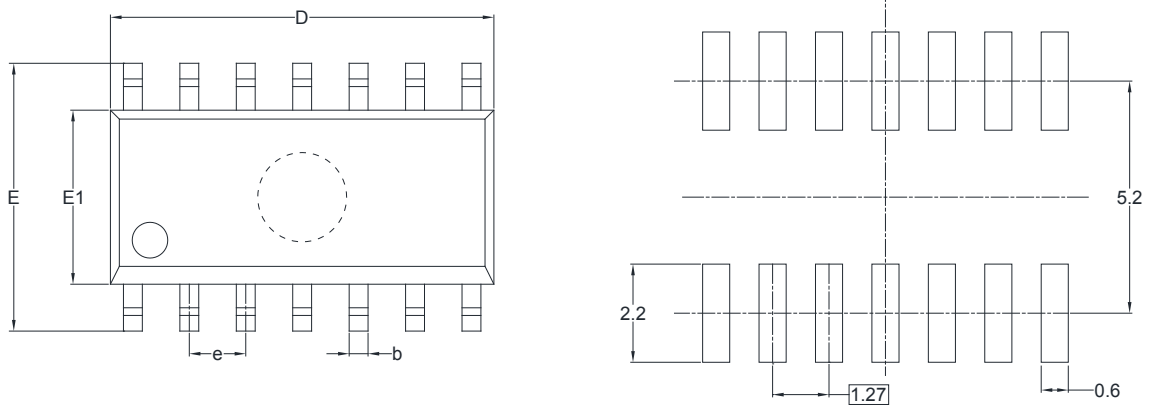

RECOMMENDED LAND PATTERN (Unit: mm)

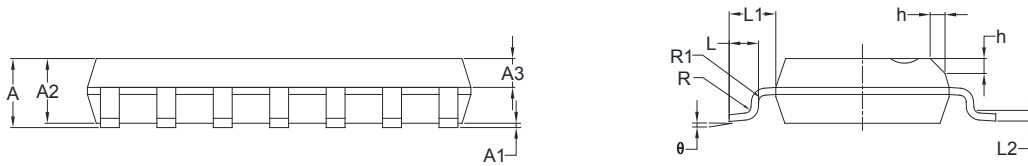

Symbol	Dimensions In Millimeters		Dimensions In Inches	
	MIN	MAX	MIN	MAX
A	1.35	1.75	0.053	0.069
A1	0.10	0.25	0.004	0.010
A2	1.25	1.65	0.049	0.065
A3	0.55	0.75	0.022	0.030
b	0.36	0.49	0.014	0.019
D	8.53	8.73	0.336	0.344
E	5.80	6.20	0.228	0.244
E1	3.80	4.00	0.150	0.157
e	1.27 BSC		0.050 BSC	
L	0.45	0.80	0.018	0.032
L1	1.04 REF		0.040 REF	
L2	0.25 BSC		0.01 BSC	
R	0.07		0.003	
R1	0.07		0.003	
h	0.30	0.50	0.012	0.020
θ	0°	8°	0°	8°

PACKAGE OUTLINE DIMENSIONS

TSSOP-14

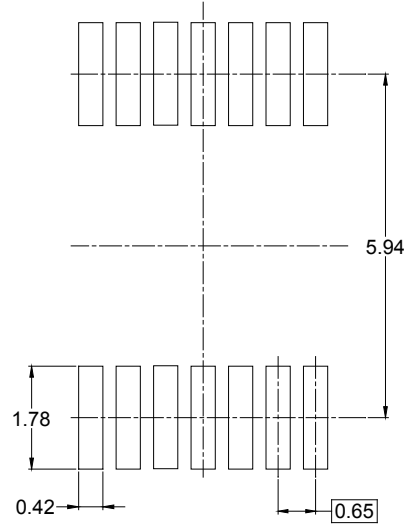
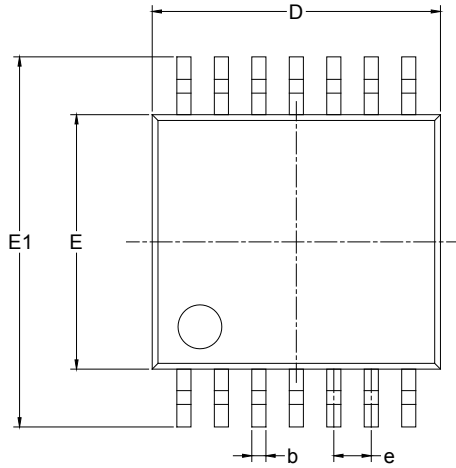

RECOMMENDED LAND PATTERN (Unit: mm)

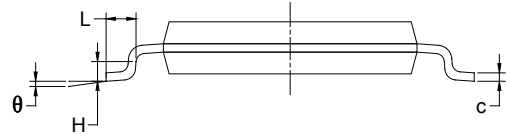
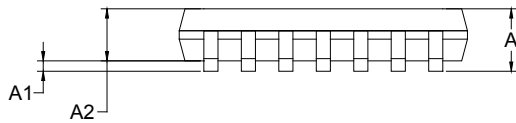

Symbol	Dimensions In Millimeters		Dimensions In Inches	
	MIN	MAX	MIN	MAX
A		1.200		0.047
A1	0.050	0.150	0.002	0.006
A2	0.800	1.050	0.031	0.041
b	0.190	0.300	0.007	0.012
c	0.090	0.200	0.004	0.008
D	4.860	5.100	0.191	0.201
E	4.300	4.500	0.169	0.177
E1	6.250	6.550	0.246	0.258
e	0.650 BSC		0.026 BSC	
L	0.500	0.700	0.02	0.028
H	0.25 TYP		0.01 TYP	
$\theta$	1°	7°	1°	7°

# PACKAGE INFORMATION

## TAPE AND REEL INFORMATION

### REEL DIMENSIONS



### TAPE DIMENSIONS



NOTE: The picture is only for reference. Please make the object as the standard.

### KEY PARAMETER LIST OF TAPE AND REEL

Package Type	Reel Diameter	Reel Width W1 (mm)	A0 (mm)	B0 (mm)	K0 (mm)	P0 (mm)	P1 (mm)	P2 (mm)	W (mm)	Pin1 Quadrant
SOT-23-5	7"	9.5	3.20	3.20	1.40	4.0	4.0	2.0	8.0	Q3
SOIC-8	13"	12.4	6.40	5.40	2.10	4.0	8.0	2.0	12.0	Q1
MSOP-8	13"	12.4	5.20	3.30	1.50	4.0	8.0	2.0	12.0	Q1
SOIC-14	13"	16.4	6.60	9.30	2.10	4.0	8.0	2.0	16.0	Q1
TSSOP-14	13"	12.4	6.95	5.60	1.20	4.0	8.0	2.0	12.0	Q1

D20001



# PACKAGE INFORMATION

## CARTON BOX DIMENSIONS



NOTE: The picture is only for reference. Please make the object as the standard.

## KEY PARAMETER LIST OF CARTON BOX

Reel Type	Length (mm)	Width (mm)	Height (mm)	Pizza/Carton
7" (Option)	368	227	224	8
7"	442	410	224	18
13"	386	280	370	5

DD0002