



# SGM8631/SGM8632/SGM8633 6MHz, Rail-to-Rail I/O CMOS Operational Amplifiers

## GENERAL DESCRIPTION

The SGM8631/2/3 are a family of single and dual operational amplifiers, which are optimized for low voltage, low noise and low power operation. These devices can operate from 2V to 5.5V single supply, and consume low quiescent current. The supply current of SGM8633 is less than 1 $\mu$ A in power-down mode.

The SGM8631/2/3 feature a 3.5mV maximum input offset voltage. The minimum input common mode voltage is within 0.1V below the negative rail, and the output swing is rail-to-rail with heavy loads. They exhibit a high gain-bandwidth product of 6MHz and a slew rate of 3.7V/ $\mu$ s. These specifications make the operational amplifiers appropriate for various applications.

The SGM8631 is available in Green SC70-5, SOT-23-5 and SOIC-8 packages. The SGM8632 is available in Green SOIC-8 and MSOP-8 packages. The SGM8633 is available in Green SOT-23-6 and SOIC-8 packages. They are specified over the extended industrial temperature range (-40°C to +125°C).

## FEATURES

- **Input Offset Voltage: 3.5mV (MAX)**
- **High Gain-Bandwidth Product: 6MHz**
- **High Slew Rate: 3.7V/ $\mu$ s**
- **Settling Time to 0.1% with 2V Step: 0.5 $\mu$ s**
- **Overload Recovery Time: 0.9 $\mu$ s**
- **Low Noise: 13nV/ $\sqrt{\text{Hz}}$  at 1kHz**
- **Rail-to-Rail Input and Output**
- **Supply Voltage Range: 2V to 5.5V**
- **Input Voltage Range: -0.1V to 5.6V with  $V_S = 5.5V$**
- **Low Supply Current:**
  - **SGM8631/3: 570 $\mu$ A (TYP)**
  - **SGM8632: 480 $\mu$ A/Amplifier (TYP)**
  - **SGM8633 Less than 1 $\mu$ A when Disabled**
- **-40°C to +125°C Operating Temperature Range**
- **Small Packaging:**
  - **SGM8631 Available in Green SC70-5, SOT-23-5 and SOIC-8 Packages**
  - **SGM8632 Available in Green MSOP-8 and SOIC-8 Packages**
  - **SGM8633 Available in Green SOT-23-6 and SOIC-8 Packages**

## APPLICATIONS

Sensors  
Audio  
Active Filters  
A/D Converters  
Communications  
Test Equipment  
Cellular and Cordless Phones  
Laptops and PDAs  
Photodiode Amplification  
Battery-Powered Instrumentation

**PACKAGE/ORDERING INFORMATION**

MODEL	PACKAGE DESCRIPTION	SPECIFIED TEMPERATURE RANGE	ORDERING NUMBER	PACKAGE MARKING	PACKING OPTION
SGM8631	SC70-5	-40°C to +125°C	SGM8631XC5/TR	8631	Tape and Reel, 3000
	SOT-23-5	-40°C to +125°C	SGM8631XN5/TR	8631	Tape and Reel, 3000
	SOIC-8	-40°C to +125°C	SGM8631XS/TR	SGM8631XS XXXXX	Tape and Reel, 2500
SGM8632	MSOP-8	-40°C to +125°C	SGM8632XMS/TR	SGM8632 XMS XXXXX	Tape and Reel, 3000
	SOIC-8	-40°C to +125°C	SGM8632XS/TR	SGM8632XS XXXXX	Tape and Reel, 2500
SGM8633	SOT-23-6	-40°C to +125°C	SGM8633XN6/TR	8633	Tape and Reel, 3000
	SOIC-8	-40°C to +125°C	SGM8633XS/TR	SGM8633XS XXXXX	Tape and Reel, 2500

**MARKING INFORMATION**

NOTE: XXXXX = Date Code and Vendor Code.

**SOIC-8/MSOP-8**

**XXXXX**

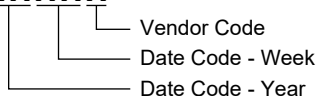

Green (RoHS & HSF): SG Micro Corp defines "Green" to mean Pb-Free (RoHS compatible) and free of halogen substances. If you have additional comments or questions, please contact your SGMICRO representative directly.

**ABSOLUTE MAXIMUM RATINGS**

- Supply Voltage, +V<sub>S</sub> to -V<sub>S</sub> ..... 6V
- Input Common Mode Voltage Range  
..... (-V<sub>S</sub>) - 0.3V to (+V<sub>S</sub>) + 0.3V
- Package Thermal Resistance @ T<sub>A</sub> = +25°C
- SC70-5, θ<sub>JA</sub>..... 333°C/W
- SOT-23-5, θ<sub>JA</sub>..... 190°C/W
- SOT-23-6, θ<sub>JA</sub>..... 190°C/W
- SOIC-8, θ<sub>JA</sub>..... 125°C/W
- MSOP-8, θ<sub>JA</sub>..... 216°C/W
- Junction Temperature..... +150°C
- Storage Temperature Range ..... -65°C to +150°C
- Lead Temperature (Soldering, 10s)..... +260°C
- ESD Susceptibility
- HBM (SGM8631/2) ..... 8000V
- HBM (SGM8633) ..... 4000V
- MM..... 400V
- CDM ..... 1000V

**RECOMMENDED OPERATING CONDITIONS**

Operating Temperature Range ..... -40°C to +125°C

**OVERSTRESS CAUTION**

Stresses beyond those listed in Absolute Maximum Ratings may cause permanent damage to the device. Exposure to absolute maximum rating conditions for extended periods may affect reliability. Functional operation of the device at any conditions beyond those indicated in the Recommended Operating Conditions section is not implied.

**ESD SENSITIVITY CAUTION**

This integrated circuit can be damaged if ESD protections are not considered carefully. SGMICRO recommends that all integrated circuits be handled with appropriate precautions. Failure to observe proper handling and installation procedures can cause damage. ESD damage can range from subtle performance degradation to complete device failure. Precision integrated circuits may be more susceptible to damage because even small parametric changes could cause the device not to meet the published specifications.

**DISCLAIMER**

SG Micro Corp reserves the right to make any change in circuit design, or specifications without prior notice.

**PIN CONFIGURATIONS**

**SGM8631 (TOP VIEW)**

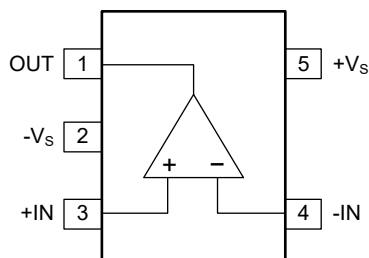

**SC70-5/SOT-23-5**

**SGM8633 (TOP VIEW)**

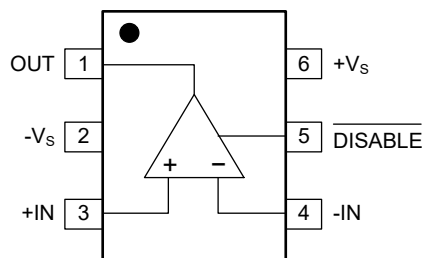

**SOT-23-6**

**SGM8632 (TOP VIEW)**

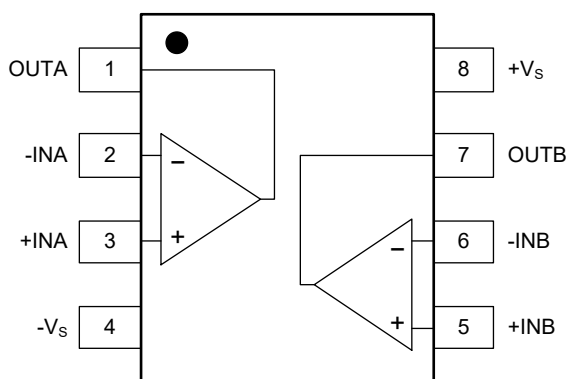

**SOIC-8/MSOP-8**

**SGM8631/8633 (TOP VIEW)**

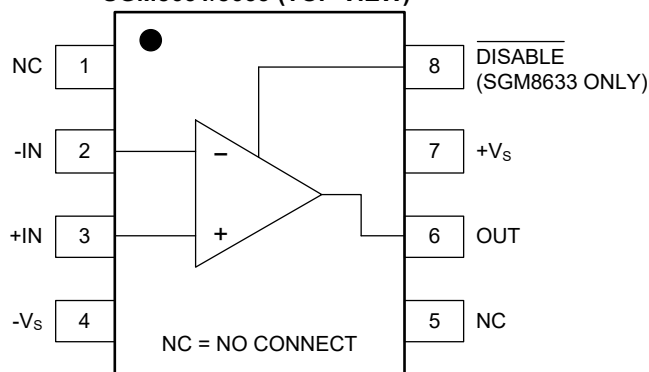

**SOIC-8**

**ELECTRICAL CHARACTERISTICS**

(At T<sub>A</sub> = +25°C, V<sub>S</sub> = 5V, V<sub>CM</sub> = V<sub>S</sub>/2, R<sub>L</sub> = 600Ω, unless otherwise noted.)

PARAMETER	CONDITIONS	SGM8631/2/3						
		TYP	MIN/MAX OVER TEMPERATURE				UNITS	MIN/MAX
		+25°C	+25°C	-40°C to +85°C	-40°C to +125°C			
<b>Input Characteristics</b>								
Input Offset Voltage (V <sub>OS</sub> )		0.9	3.5	3.7	3.8	mV	MAX	
Input Bias Current (I <sub>B</sub> )		1				pA	TYP	
Input Offset Current (I <sub>OS</sub> )		1				pA	TYP	
Input Common Mode Voltage Range (V <sub>CM</sub> )	V <sub>S</sub> = 5.5V	-0.1 to 5.6				V	TYP	
Common Mode Rejection Ratio (CMRR)	V <sub>S</sub> = 5.5V, V <sub>CM</sub> = -0.1V to 4V	84	68	67	66	dB	MIN	
	V <sub>S</sub> = 5.5V, V <sub>CM</sub> = -0.1V to 5.6V	76				dB	MIN	
Open-Loop Voltage Gain (A <sub>OL</sub> )	R <sub>L</sub> = 600Ω, V <sub>OUT</sub> = 0.15V to 4.85V	86	79	73	69	dB	MIN	
	R <sub>L</sub> = 10kΩ, V <sub>OUT</sub> = 0.05V to 4.95V	103				dB	MIN	
Input Offset Voltage Drift (ΔV <sub>OS</sub> /ΔT)		2.4				μV/°C	TYP	
<b>Output Characteristics</b>								
Output Voltage Swing from Rail	R <sub>L</sub> = 600Ω	0.079				V	TYP	
	R <sub>L</sub> = 10kΩ	0.007				V	TYP	
Output Current (I <sub>OUT</sub> )		58	40	30	26	mA	MIN	
Closed-Loop Output Impedance	f = 200kHz, G = 1	5.4				Ω	TYP	
<b>Power-Down Disable (SGM8633 Only)</b>								
Turn-On Time		1.3				μs	TYP	
Turn-Off Time		0.4				μs	TYP	
DISABLE Voltage-Off			0.8			V	MAX	
DISABLE Voltage-On			2			V	MIN	
<b>Power Supply</b>								
Operating Voltage Range		2	2	2	2	V	MIN	
		5.5	5.5	5.5	5.5	V	MAX	
Power Supply Rejection Ratio (PSRR)	V <sub>S</sub> = 2V to 5.5V, V <sub>CM</sub> = (-V <sub>S</sub> ) + 0.5V	84	69	68	67	dB	MIN	
Quiescent Current/ Amplifier (I <sub>Q</sub> )	SGM8632	I <sub>OUT</sub> = 0mA	480	620	720	790	μA	MAX
	SGM8631/3	I <sub>OUT</sub> = 0mA	570	720	820	880	μA	MAX
Supply Current when Disabled (SGM8633 only)		0.5	8	9	10	μA	MAX	
<b>Dynamic Performance</b>								
Gain-Bandwidth Product (GBP)		6				MHz	TYP	
Phase Margin (φ <sub>O</sub> )		63				°	TYP	
Full Power Bandwidth (BW <sub>P</sub> )	< 1% distortion	250				kHz	TYP	
Slew Rate (SR)	G = 1, 2V output step	3.7				V/μs	TYP	
Settling Time to 0.1% (t <sub>S</sub> )	G = 1, 2V output step	0.5				μs	TYP	
Overload Recovery Time	V <sub>IN</sub> × G = V <sub>S</sub>	0.9				μs	TYP	
<b>Noise Performance</b>								
Input Voltage Noise Density (e <sub>n</sub> )	f = 1kHz	13				nV/√Hz	TYP	

**TYPICAL PERFORMANCE CHARACTERISTICS**

At  $T_A = +25^\circ\text{C}$ ,  $V_{CM} = V_S/2$ ,  $R_L = 600\Omega$ , unless otherwise noted.

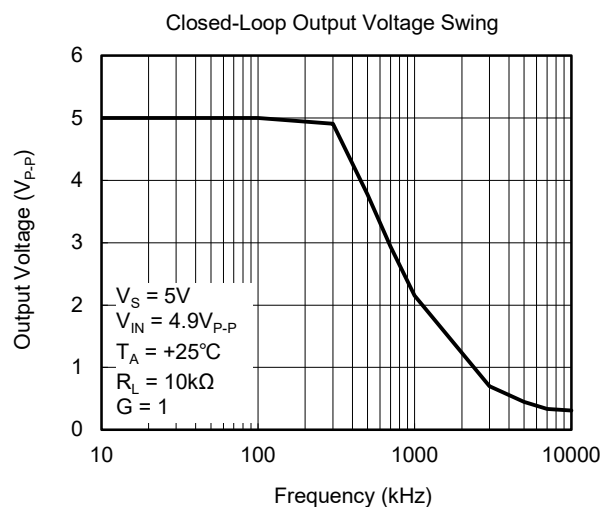
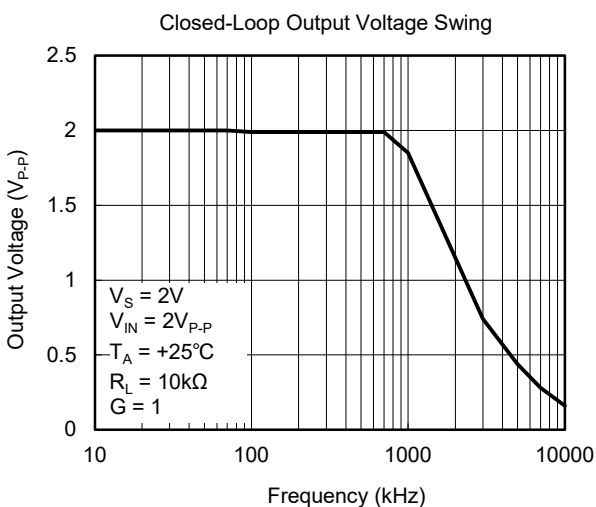
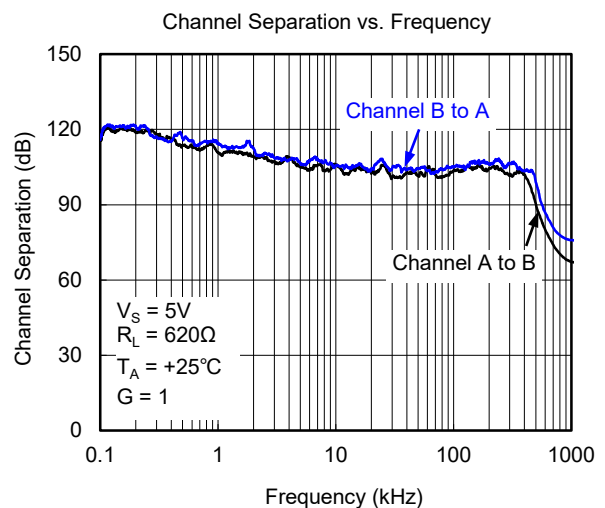
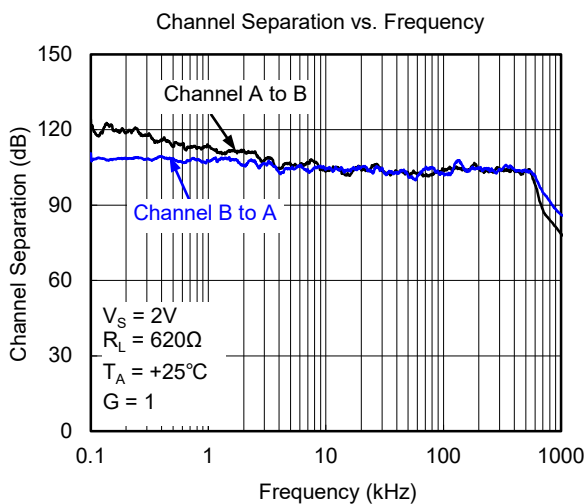
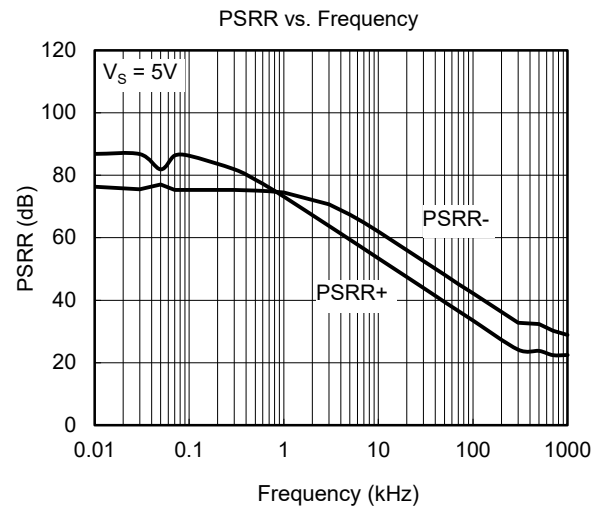
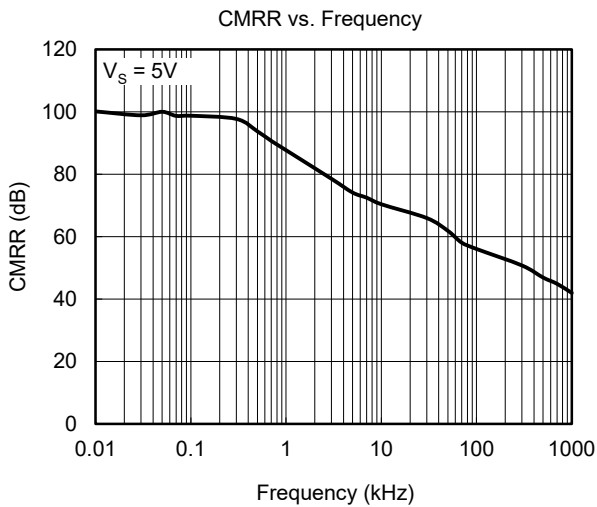

**TYPICAL PERFORMANCE CHARACTERISTICS (continued)**

At  $T_A = +25^\circ\text{C}$ ,  $V_{CM} = V_S/2$ ,  $R_L = 600\Omega$ , unless otherwise noted.

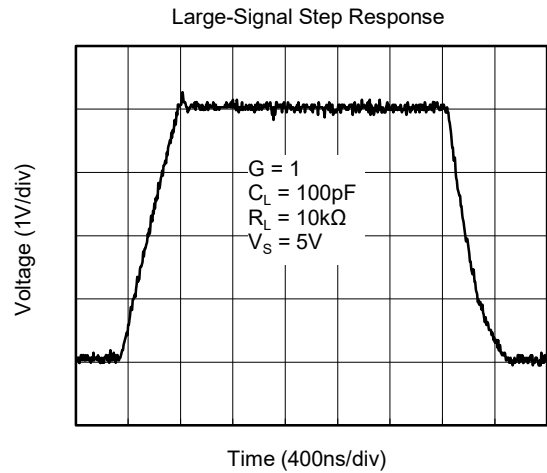
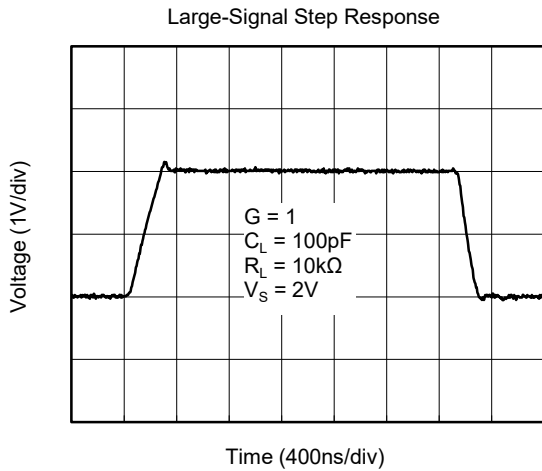
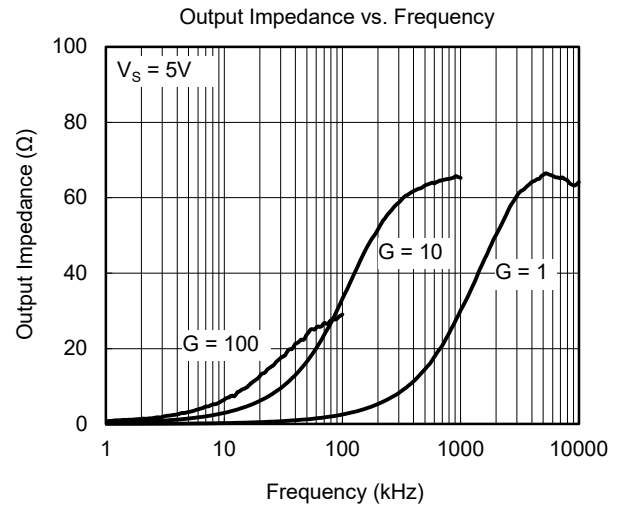
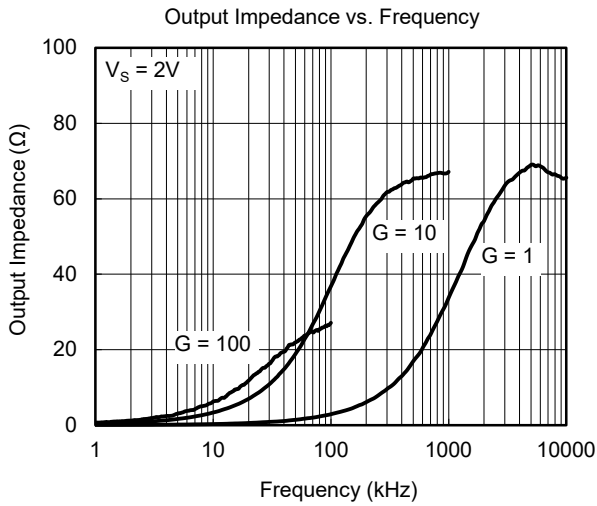
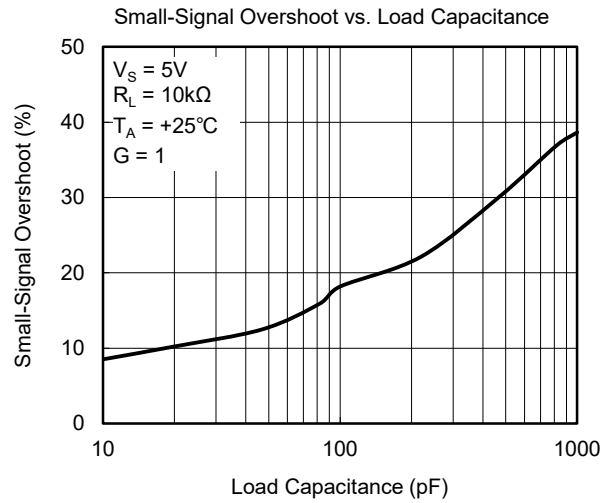
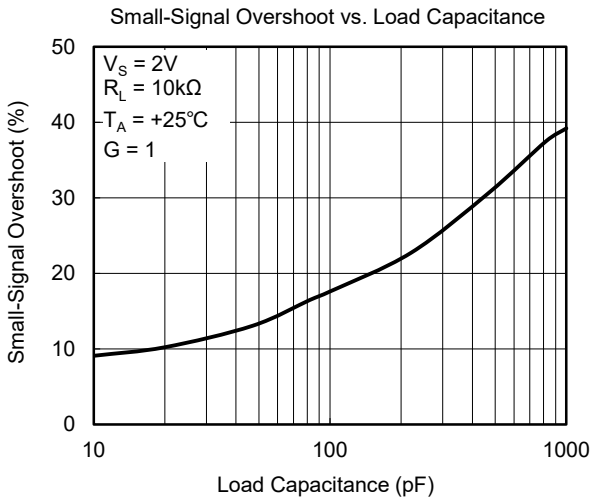

**TYPICAL PERFORMANCE CHARACTERISTICS (continued)**

At  $T_A = +25^\circ\text{C}$ ,  $V_{CM} = V_S/2$ ,  $R_L = 600\Omega$ , unless otherwise noted.

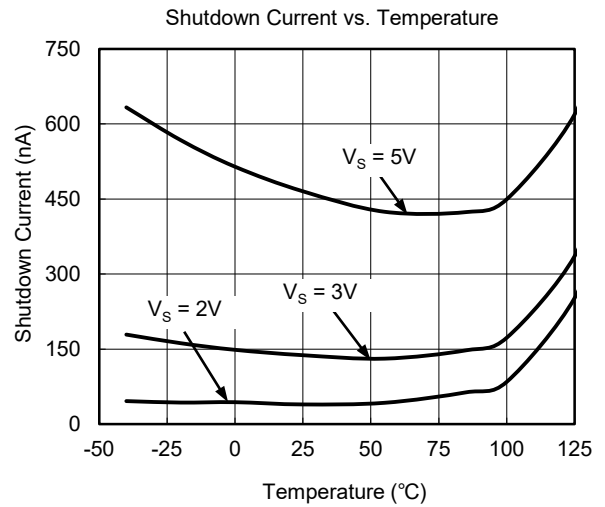
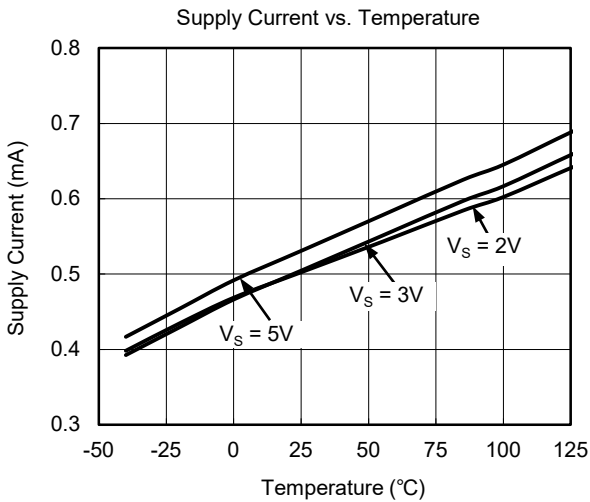
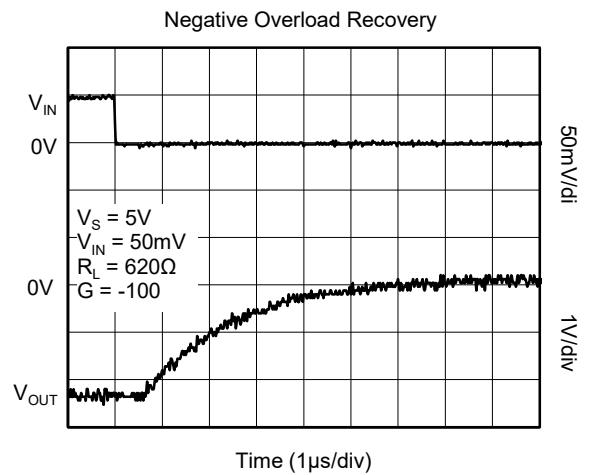
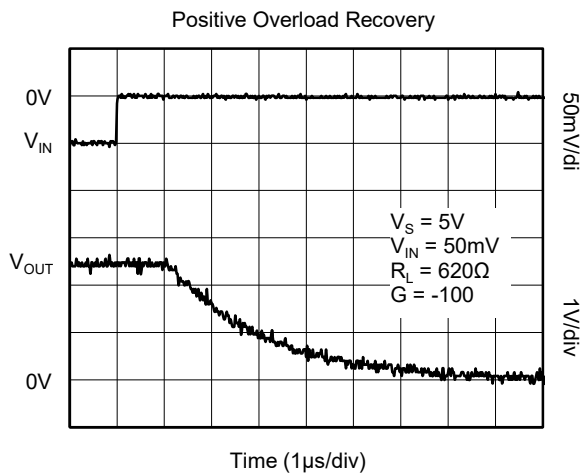
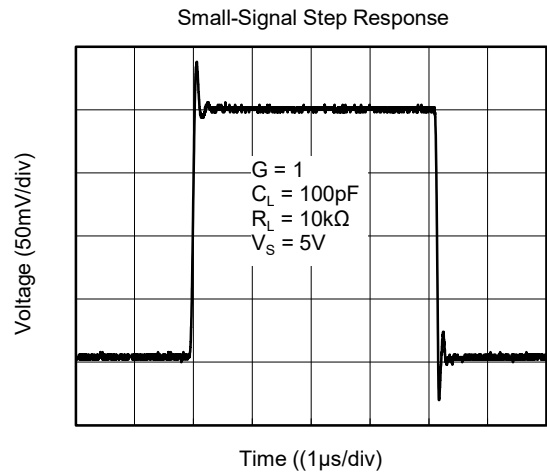
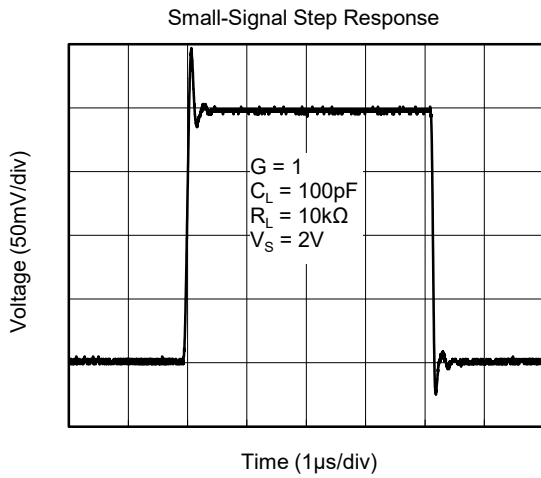

**TYPICAL PERFORMANCE CHARACTERISTICS (continued)**

At  $T_A = +25^\circ\text{C}$ ,  $V_{CM} = V_S/2$ ,  $R_L = 600\Omega$ , unless otherwise noted.

CMRR vs. Temperature

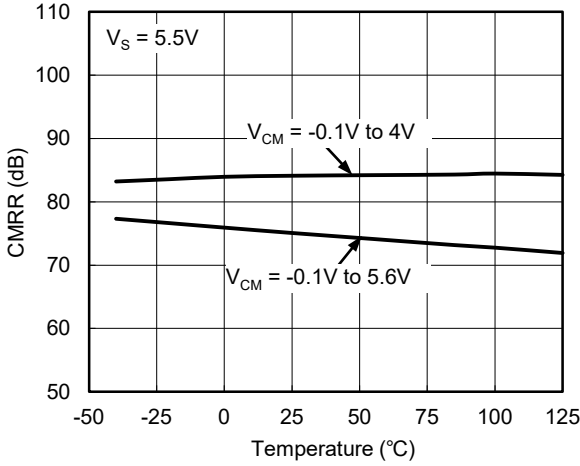

PSRR vs. Temperature

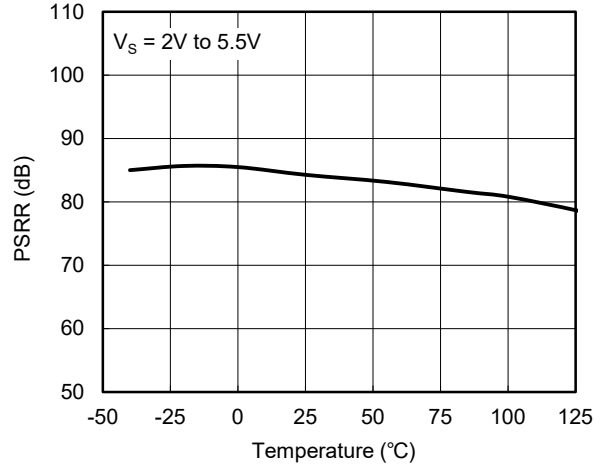

Open-Loop Voltage Gain vs. Temperature

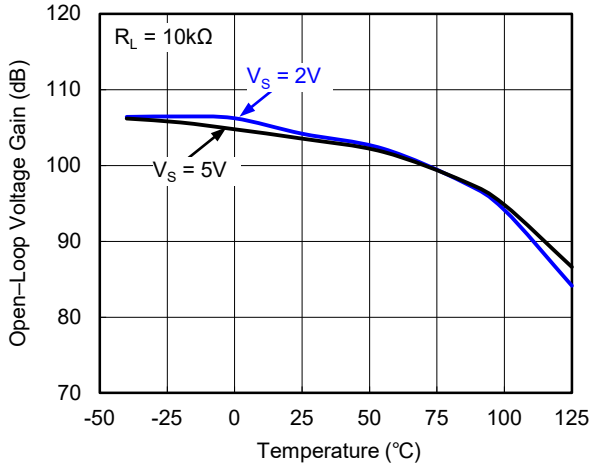

Open-Loop Voltage Gain vs. Temperature

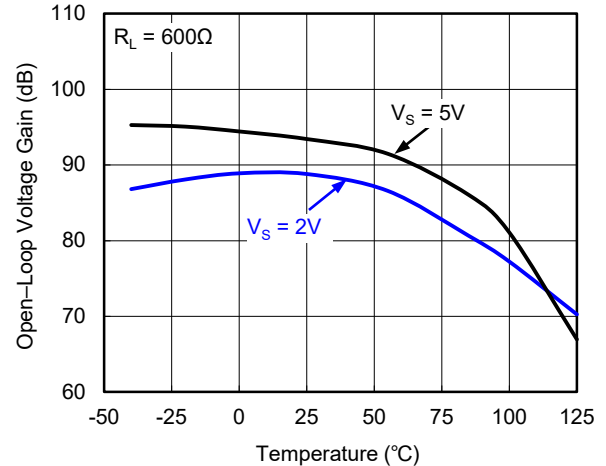

Output Voltage Swing vs. Output Current

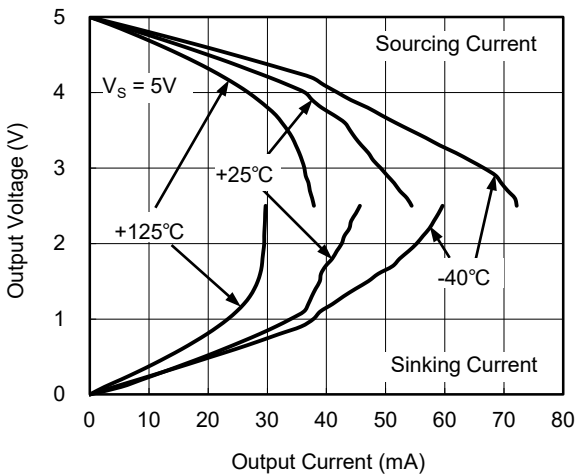

Output Voltage Swing vs. Output Current

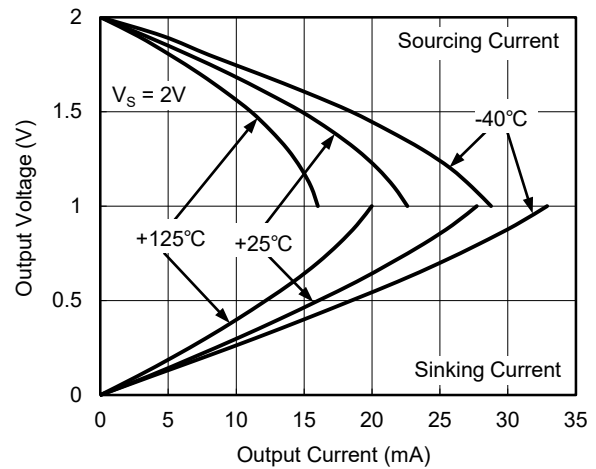



**TYPICAL PERFORMANCE CHARACTERISTICS (continued)**

At  $T_A = +25^\circ\text{C}$ ,  $V_{CM} = V_S/2$ ,  $R_L = 600\Omega$ , unless otherwise noted.

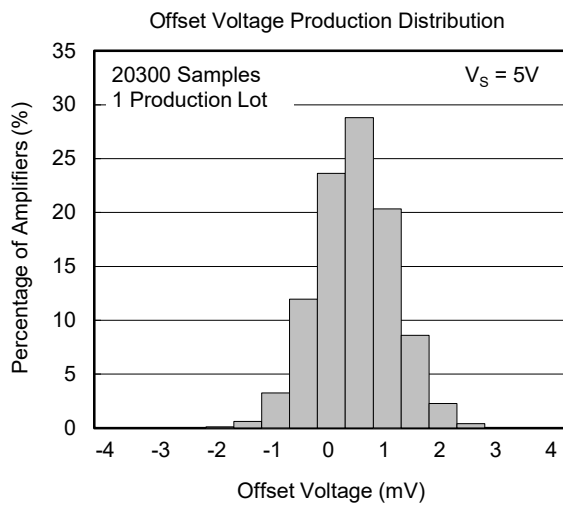
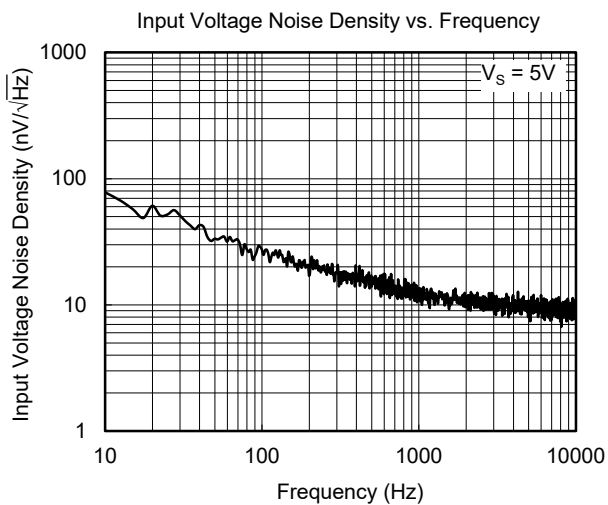

**APPLICATION INFORMATION**

**Rail-to-Rail Input**

When SGM8631/2/3 work at the power supply between 2V and 5.5V, the input common mode voltage range is from  $(-V_S) - 0.1V$  to  $(+V_S) + 0.1V$ . In Figure 1, the ESD diodes between the inputs and the power supply rails will clamp the input voltage not to exceed the rails.

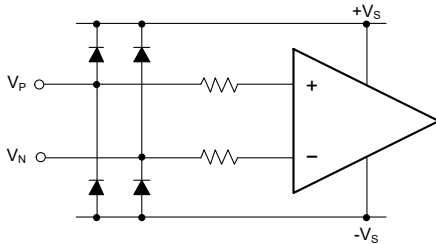

**Figure 1. Input Equivalent Circuit**

**Rail-to-Rail Output**

The SGM8631/2/3 support rail-to-rail output operation. In single power supply application, for example, when  $+V_S = 5V$ ,  $-V_S = GND$ ,  $10k\Omega$  load resistor is tied from OUT pin to ground, the typical output swing range is from 0.007V to 4.993V.

**Driving Capacitive Loads**

The SGM8631/2/3 are designed for driving the 1000pF capacitive load with unity-gain stable. If greater capacitive load must be driven in application, the circuit in Figure 2 can be used. In this circuit, the IR drop voltage generated by  $R_{ISO}$  is compensated by feedback loop.

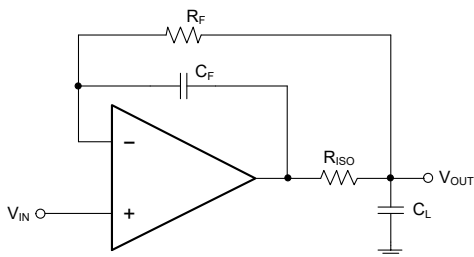

**Figure 2. Circuit to Drive Heavy Capacitive Load**

**Power Supply Decoupling and Layout**

A clean and low noise power supply is very important in amplifier circuit design, besides of input signal noise, the power supply is one of important source of noise to the amplifiers through  $+V_S$  and  $-V_S$  pins. Power supply bypassing is an effective method to clear up the noise at power supply, and the low impedance path to ground of decoupling capacitor will bypass the noise to GND. In application,  $10\mu F$  ceramic capacitor paralleled with  $0.1\mu F$  or  $0.01\mu F$  ceramic capacitor is used in Figure 3. The ceramic capacitors should be placed as close as possible to  $+V_S$  and  $-V_S$  power supply pins.

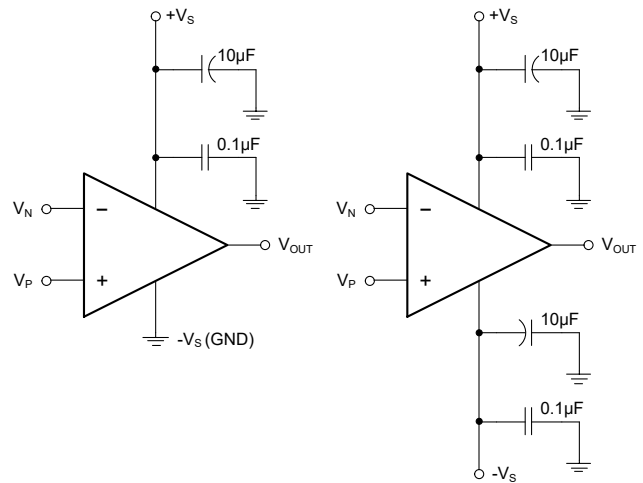

**Figure 3. Amplifier Power Supply Bypassing**

**Grounding**

In low speed application, one node grounding technique is the simplest and most effective method to eliminate the noise generated by grounding. In high speed application, the general method to eliminate noise is to use a complete ground plane technique, and the whole ground plane will help distribute heat and reduce EMI noise pickup.

**Reduce Input-to-Output Coupling**

To reduce the input-to-output coupling, the input traces must be placed as far away from the power supply or output traces as possible. The sensitive trace must not be placed in parallel with the noisy trace in same layer. They must be placed perpendicularly in different layers to reduce the crosstalk. These PCB layout techniques will help to reduce unwanted positive feedback and noise.

**APPLICATION INFORMATION (continued)**

**Typical Application Circuits**

**Difference Amplifier**

The circuit in Figure 4 is a design example of classical difference amplifier. If  $R_4/R_3 = R_2/R_1$ , then  $V_{OUT} = (V_P - V_N) \times R_2/R_1 + V_{REF}$ .

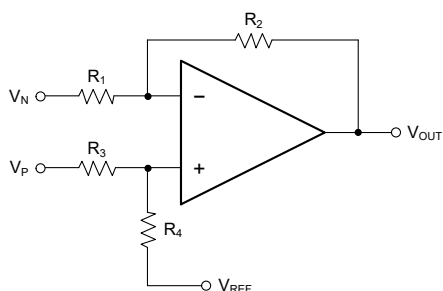

**Figure 4. Difference Amplifier**

**High Input Impedance Difference Amplifier**

The circuit in Figure 5 is a design example of high input impedance difference amplifier, the added amplifiers at the input are used to increase the input impedance and eliminate drawback of low input impedance in Figure 4.

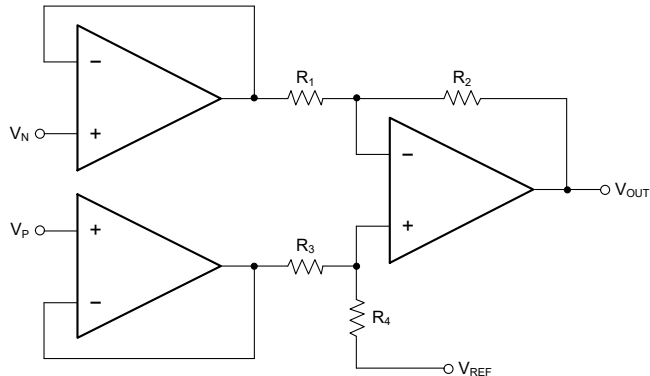

**Figure 5. High Input Impedance Difference Amplifier**

**Active Low-Pass Filter**

The circuit in Figure 6 is a design example of active low-pass filter, the DC gain is equal to  $-R_2/R_1$  and the -3dB corner frequency is equal to  $1/2\pi R_2 C$ . In this design, the filter bandwidth must be less than the bandwidth of the amplifier, the resistor values must be selected as low as possible to reduce ringing or oscillation generated by the parasitic parameters in PCB layout.

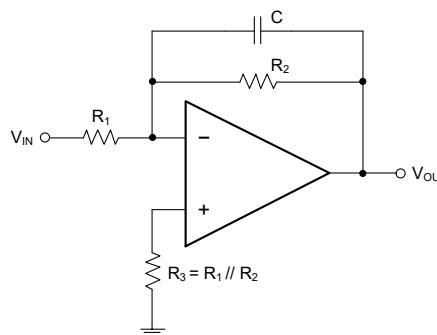

**Figure 6. Active Low-Pass Filter**

## REVISION HISTORY

NOTE: Page numbers for previous revisions may differ from page numbers in the current version.

<b>JULY 2023 – REV.C.3 to REV.C.4</b>	<b>Page</b>
Updated Package Outline Dimensions section .....	13
<hr/>	
<b>JULY 2016 – REV.C.2 to REV.C.3</b>	<b>Page</b>
Changed Electrical Characteristics section .....	4
<hr/>	
<b>AUGUST 2015 – REV.C.1 to REV.C.2</b>	<b>Page</b>
New version.....	All
<hr/>	
<b>February 2015 – REV.C to REV.C.1</b>	<b>Page</b>
Changed Package Outline Dimensions section .....	17, 18

---

PACKAGE OUTLINE DIMENSIONS

SC70-5

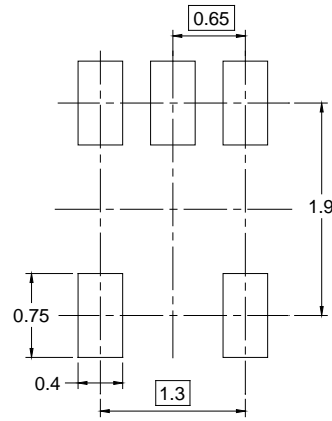
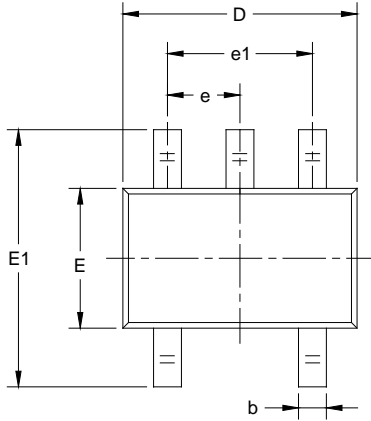

RECOMMENDED LAND PATTERN (Unit: mm)

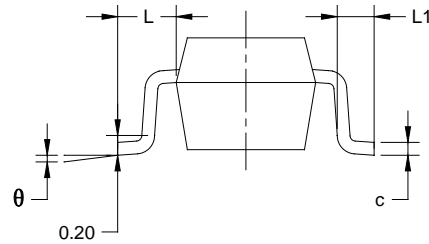
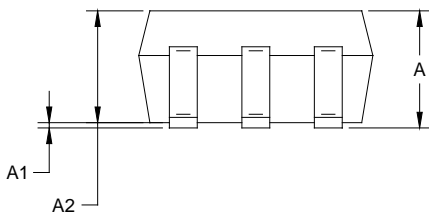

Symbol	Dimensions In Millimeters		Dimensions In Inches	
	MIN	MAX	MIN	MAX
A	0.800	1.100	0.031	0.043
A1	0.000	0.100	0.000	0.004
A2	0.800	1.000	0.031	0.039
b	0.150	0.350	0.006	0.014
c	0.080	0.220	0.003	0.009
D	2.000	2.200	0.079	0.087
E	1.150	1.350	0.045	0.053
E1	2.150	2.450	0.085	0.096
e	0.65 TYP		0.026 TYP	
e1	1.300 BSC		0.051 BSC	
L	0.525 REF		0.021 REF	
L1	0.260	0.460	0.010	0.018
$\theta$	0°	8°	0°	8°

NOTES:

1. Body dimensions do not include mold flash or protrusion.
2. This drawing is subject to change without notice.

## PACKAGE OUTLINE DIMENSIONS

### SOT-23-5

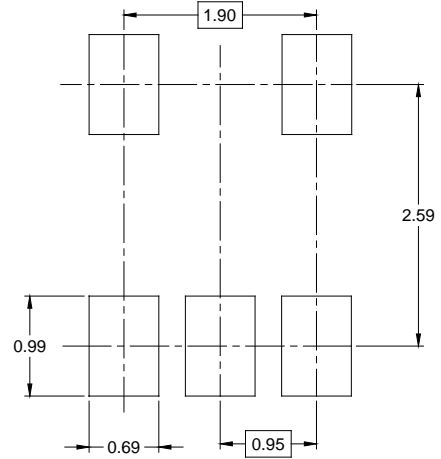
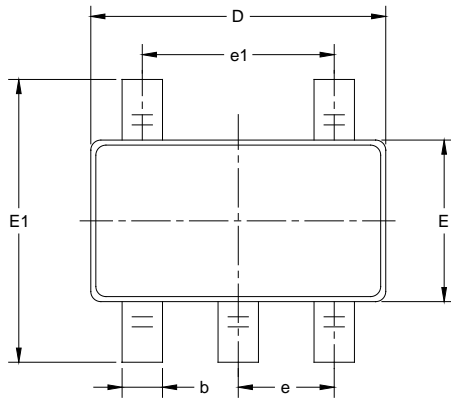

RECOMMENDED LAND PATTERN (Unit: mm)

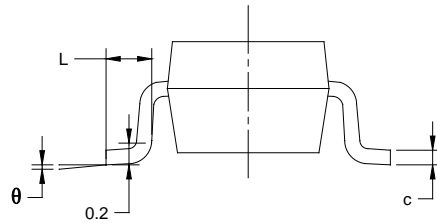
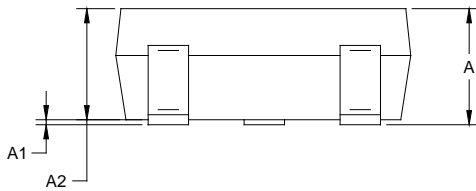

Symbol	Dimensions In Millimeters		Dimensions In Inches	
	MIN	MAX	MIN	MAX
A	1.050	1.250	0.041	0.049
A1	0.000	0.100	0.000	0.004
A2	1.050	1.150	0.041	0.045
b	0.300	0.500	0.012	0.020
c	0.100	0.200	0.004	0.008
D	2.820	3.020	0.111	0.119
E	1.500	1.700	0.059	0.067
E1	2.650	2.950	0.104	0.116
e	0.950 BSC		0.037 BSC	
e1	1.900 BSC		0.075 BSC	
L	0.300	0.600	0.012	0.024
$\theta$	0°	8°	0°	8°

**NOTES:**

1. Body dimensions do not include mode flash or protrusion.
2. This drawing is subject to change without notice.

PACKAGE OUTLINE DIMENSIONS

SOT-23-6

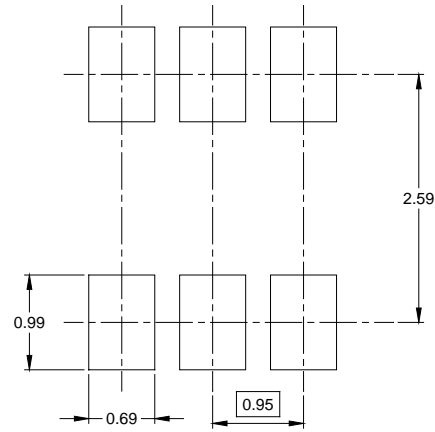
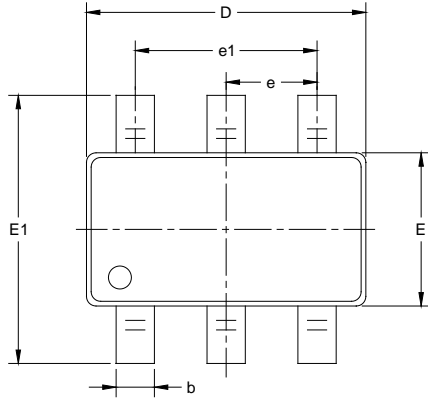

RECOMMENDED LAND PATTERN (Unit: mm)

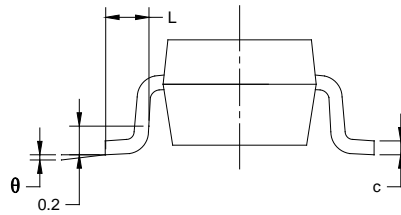
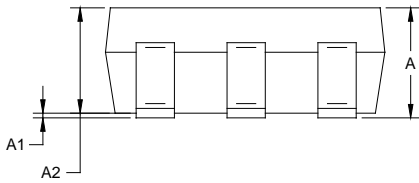

Symbol	Dimensions In Millimeters		Dimensions In Inches	
	MIN	MAX	MIN	MAX
A	1.050	1.250	0.041	0.049
A1	0.000	0.100	0.000	0.004
A2	1.050	1.150	0.041	0.045
b	0.300	0.500	0.012	0.020
c	0.100	0.200	0.004	0.008
D	2.820	3.020	0.111	0.119
E	1.500	1.700	0.059	0.067
E1	2.650	2.950	0.104	0.116
e	0.950 BSC		0.037 BSC	
e1	1.900 BSC		0.075 BSC	
L	0.300	0.600	0.012	0.024
$\theta$	0°	8°	0°	8°

NOTES:

1. Body dimensions do not include mode flash or protrusion.
2. This drawing is subject to change without notice.

PACKAGE OUTLINE DIMENSIONS

SOIC-8

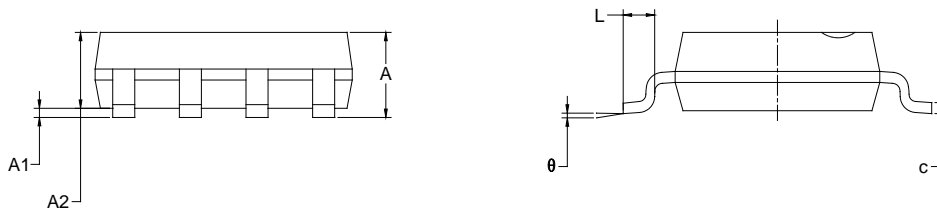
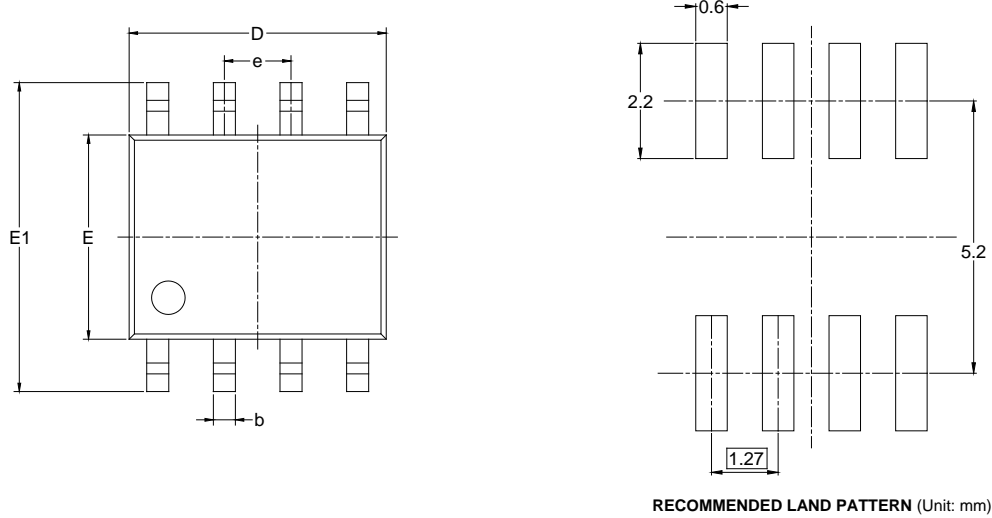

Symbol	Dimensions In Millimeters		Dimensions In Inches	
	MIN	MAX	MIN	MAX
A	1.350	1.750	0.053	0.069
A1	0.100	0.250	0.004	0.010
A2	1.350	1.550	0.053	0.061
b	0.330	0.510	0.013	0.020
c	0.170	0.250	0.006	0.010
D	4.700	5.100	0.185	0.200
E	3.800	4.000	0.150	0.157
E1	5.800	6.200	0.228	0.244
e	1.27 BSC		0.050 BSC	
L	0.400	1.270	0.016	0.050
θ	0°	8°	0°	8°

NOTES:  
 1. Body dimensions do not include mode flash or protrusion.  
 2. This drawing is subject to change without notice.



PACKAGE OUTLINE DIMENSIONS

MSOP-8

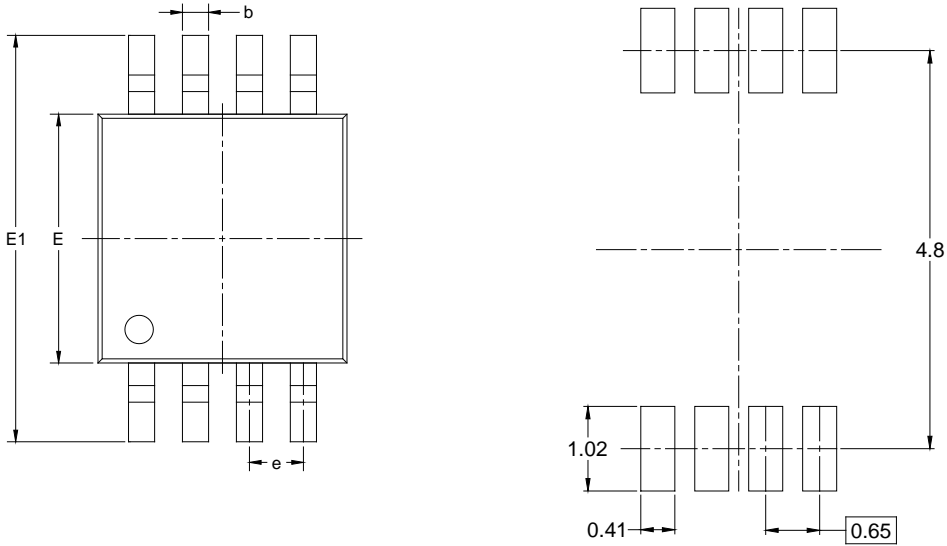

RECOMMENDED LAND PATTERN (Unit: mm)

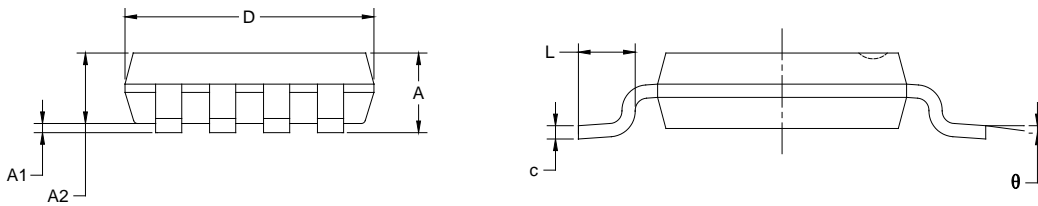

Symbol	Dimensions In Millimeters		Dimensions In Inches	
	MIN	MAX	MIN	MAX
A	0.820	1.100	0.032	0.043
A1	0.020	0.150	0.001	0.006
A2	0.750	0.950	0.030	0.037
b	0.250	0.380	0.010	0.015
c	0.090	0.230	0.004	0.009
D	2.900	3.100	0.114	0.122
E	2.900	3.100	0.114	0.122
E1	4.750	5.050	0.187	0.199
e	0.650 BSC		0.026 BSC	
L	0.400	0.800	0.016	0.031
θ	0°	6°	0°	6°

NOTES:

1. Body dimensions do not include mode flash or protrusion.
2. This drawing is subject to change without notice.

# PACKAGE INFORMATION

## TAPE AND REEL INFORMATION

### REEL DIMENSIONS



### TAPE DIMENSIONS



NOTE: The picture is only for reference. Please make the object as the standard.

### KEY PARAMETER LIST OF TAPE AND REEL

Package Type	Reel Diameter	Reel Width W1 (mm)	A0 (mm)	B0 (mm)	K0 (mm)	P0 (mm)	P1 (mm)	P2 (mm)	W (mm)	Pin1 Quadrant
SC70-5	7"	9.5	2.40	2.50	1.20	4.0	4.0	2.0	8.0	Q3
SOT-23-5	7"	9.5	3.20	3.20	1.40	4.0	4.0	2.0	8.0	Q3
SOT-23-6	7"	9.5	3.23	3.17	1.37	4.0	4.0	2.0	8.0	Q3
SOIC-8	13"	12.4	6.40	5.40	2.10	4.0	8.0	2.0	12.0	Q1
MSOP-8	13"	12.4	5.20	3.30	1.50	4.0	8.0	2.0	12.0	Q1

D20001

# PACKAGE INFORMATION

## CARTON BOX DIMENSIONS



NOTE: The picture is only for reference. Please make the object as the standard.

## KEY PARAMETER LIST OF CARTON BOX

Reel Type	Length (mm)	Width (mm)	Height (mm)	Pizza/Carton
7" (Option)	368	227	224	8
7"	442	410	224	18
13"	386	280	370	5

DD0002