

GENERAL DESCRIPTION

The SGM9117 is a rail-to-rail, triple high-speed video buffer which can operate from 2.5V to 5.5V single power supply, while consuming an ultra-low 27.5mA quiescent current. The device is optimized for low power, battery-operated applications.

The device has a -3dB bandwidth of 200MHz and 300V/ μ s slew rate. The gain is 0.01% and the phase error is 0.02°. Crosstalk at 1MHz is -65dB.

The SGM9117 is available in a Green SOIC-8 package. It operates over an ambient temperature range of -40°C to +125°C.

FEATURES

- **Supply Voltage Range: 2.5V to 5.5V**
- **Transparent Input Clamping**
- **Internal Gain: 6dB**
- **Drive Dual Video Loads**
- **Quiescent Current: 27.5mA (TYP)**
- **AC- or DC-Coupled Inputs**
- **AC- or DC-Coupled Outputs**
- **Rail-to-Rail Output**
- **-40°C to +125°C Operating Temperature Range**
- **Available in a Green SOIC-8 Package**

APPLICATIONS

- Video Amplifiers
- Video Recorders
- Video on Demand (VOD)
- Cable and Satellite Set-Top Boxes
- Portable and Handheld Products
- Communication Devices
- HDTVs

BLOCK DIAGRAM

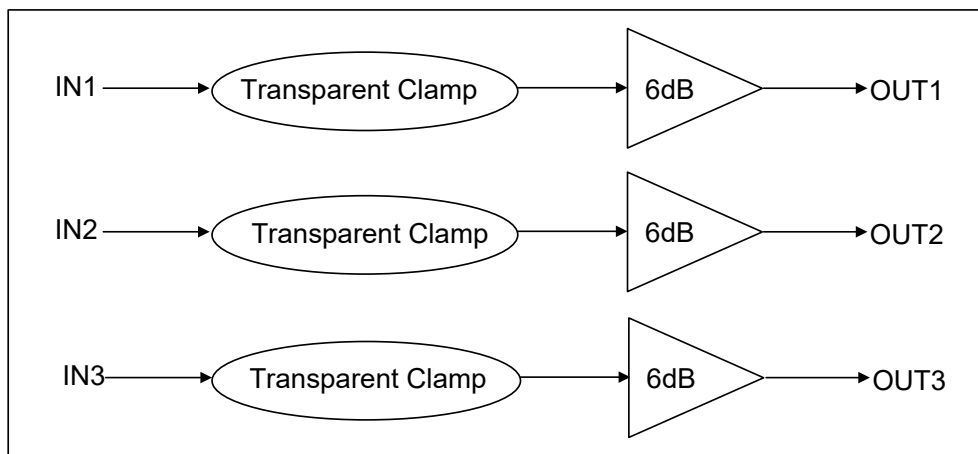

PACKAGE/ORDERING INFORMATION

MODEL	PACKAGE DESCRIPTION	SPECIFIED TEMPERATURE RANGE	ORDERING NUMBER	PACKAGE MARKING	PACKING OPTION
SGM9117	SOIC-8	-40°C to +125°C	SGM9117XS/TR	SGM9117XS XXXXX	Tape and Reel, 2500

MARKING INFORMATION

NOTE: XXXXX = Date Code and Vendor Code.

XXXXX

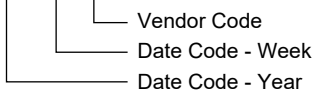

Green (RoHS & HSF): SG Micro Corp defines "Green" to mean Pb-Free (RoHS compatible) and free of halogen substances. If you have additional comments or questions, please contact your SGMICRO representative directly.

Input Voltage Range	GND - 0.3V to (+V _S) + 0.3V
Supply Voltage, +V _S to GND.....	7.5V
Junction Temperature	150°C
Storage Temperature Range.....	-65°C to +150°C
Lead Temperature (Soldering, 10s)	260°C
ESD Susceptibility	
HBM.....	4000V
MM.....	400V

RECOMMENDED OPERATING CONDITIONS

Operating Voltage Range.....	2.5V to 5.5V
Operating Temperature Range	-40°C to +125°C

OVERSTRESS CAUTION

Stresses beyond those listed in Absolute Maximum Ratings may cause permanent damage to the device. Exposure to absolute maximum rating conditions for extended periods may affect reliability. Functional operation of the device at any conditions beyond those indicated in the Recommended Operating Conditions section is not implied.

ESD SENSITIVITY CAUTION

This integrated circuit can be damaged if ESD protections are not considered carefully. SGMICRO recommends that all integrated circuits be handled with appropriate precautions. Failure to observe proper handling and installation procedures can cause damage. ESD damage can range from subtle performance degradation to complete device failure. Precision integrated circuits may be more susceptible to damage because even small parametric changes could cause the device not to meet the published specifications.

DISCLAIMER

SG Micro Corp reserves the right to make any change in circuit design, or specifications without prior notice.

PIN CONFIGURATION

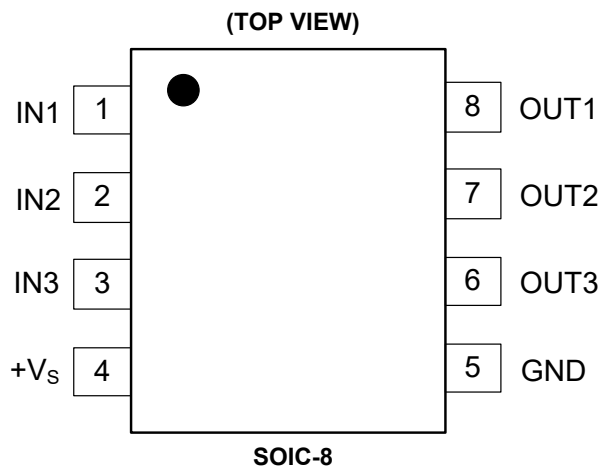

PIN DESCRIPTION

PIN	NAME	FUNCTION
1	IN1	Video Input for Channel 1.
2	IN2	Video Input for Channel 2.
3	IN3	Video Input for Channel 3.
4	+V _S	Power Supply.
5	GND	Ground.
6	OUT3	Video Output for Channel 3.
7	OUT2	Video Output for Channel 2.
8	OUT1	Video Output for Channel 1.

ELECTRICAL CHARACTERISTICS(At $R_L = 150\Omega$ connected to GND, $V_{IN} = 100mV_{PP}$ and $C_{IN} = 0.1\mu F$, all outputs AC-coupled with $220\mu F$, unless otherwise noted.)

PARAMETER	CONDITIONS	SGM9117							
		TYP	MIN/MAX OVER TEMPERATURE					UNITS	MIN/ MAX
		+25°C	+25°C	0°C to 70°C	-40°C to +85°C	-40°C to +125°C			
Input Characteristics									
Output Level Shift Voltage (V_{OLS})	$V_{IN} = 0V$, No load	261	348	355	365	395	mV	MAX	
Input Voltage Clamp (V_{CLAMP})	$I_{IN} = -1mA$	-4.3	-20	-22	-26	-29	mV	MIN	
Clamp Charge Current	$V_{IN} = V_{CLAMP} - 100mV$	-5.3	-6.8	-6.9	-7.5	-8.1	mA	MIN	
Voltage Gain (A_V)	$R_L = 150\Omega$	1.97	1.90	1.88	1.85	1.80	V/V	MIN	
			2.06	2.08	2.1	2.13	V/V	MAX	
Output Characteristics									
Output Voltage High Swing	$V_{IN} = 3V$, $R_L = 150\Omega$ to GND	4.5	4.3	4.28	4.25	4.2	V	MIN	
Output Short-Circuit Current (I_{SC})	$V_{IN} = 3V$, to GND through 10Ω	-105	-102				mA	MAX	
	$V_{IN} = 100mV$, out shorted to $+V_S$ through 10Ω	115	103				mA	MIN	
Power Supply									
Operating Voltage Range			2.5	2.7	2.7	2.7	V	MIN	
			5.5	5.5	5.5	5.5	V	MAX	
Power Supply Rejection Ratio (PSRR)	$V_S = 2.7V$ to $5.5V$	62	49	48	45	44	dB	MIN	
Quiescent Current (I_Q)	$V_{IN} = 500mV$	27.5	35	35.5	36.5	37.5	mA	MAX	
Dynamic Performance									
$\pm 0.1dB$ Bandwidth	$R_L = 150\Omega$	92					MHz	TYP	
-3dB Bandwidth	$R_L = 150\Omega$	200					MHz	TYP	
Slew Rate	20% to 80%, $V_{IN} = 1V$ Step	300					V/ μs	TYP	
Differential Gain (DG)	NTSC & PAL DC-coupled	0.01					%	TYP	
	NTSC & PAL AC-coupled	0.46					%	TYP	
Differential Phase (DP)	NTSC & PAL DC-coupled	0.02					°	TYP	
	NTSC & PAL AC-coupled	0.8					°	TYP	
Group Delay Variation (D/DT)	$f = 400kHz$, $26.5MHz$	3.0					ns	TYP	
Crosstalk (channel-to-channel)	at $1MHz$	-65					dB	TYP	
Fall Time	$2.0V_{STEP}$, 80% to 20%	5.0					ns	TYP	
Rise Time	$2.0V_{STEP}$, 80% to 20%	5.1					ns	TYP	

TYPICAL PERFORMANCE CHARACTERISTICS

At $V_S = +5.0V$, $T_A = +25^\circ C$, $R_L = 150\Omega$, all outputs AC-coupled with $220\mu F$, unless otherwise noted.

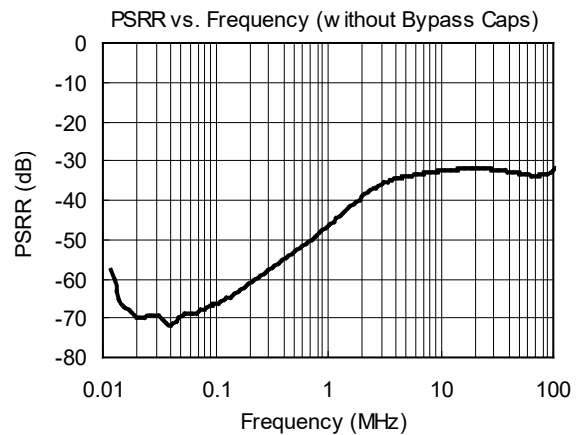
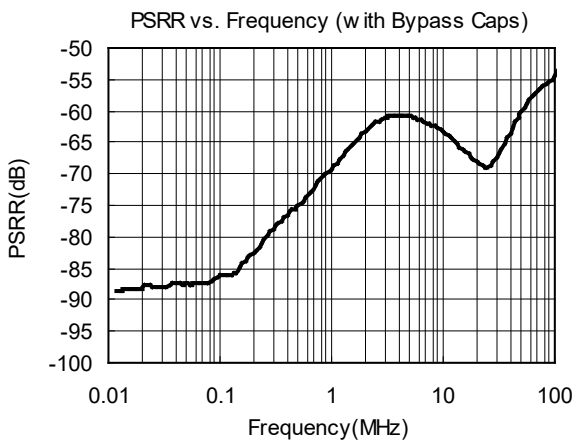
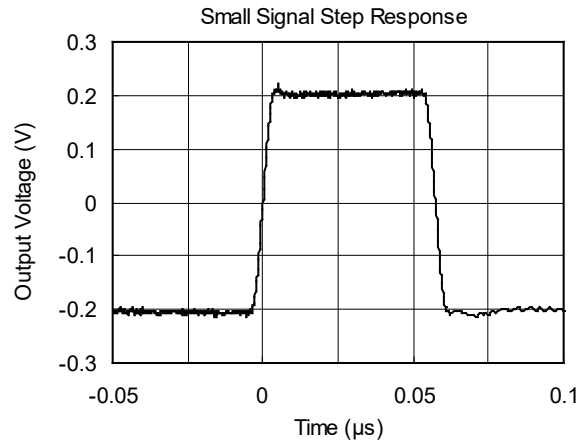
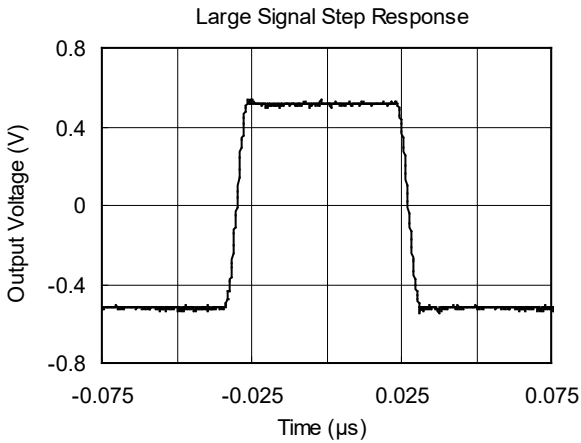
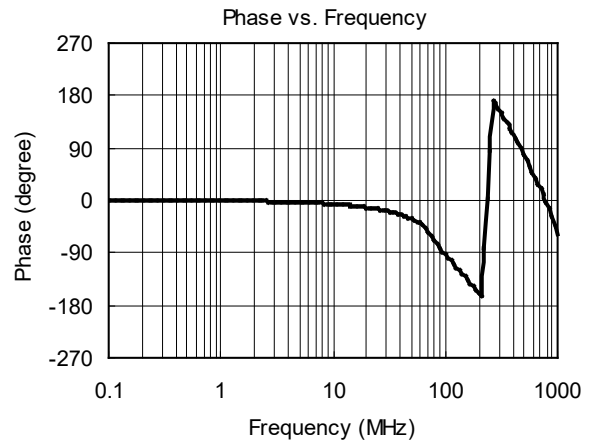
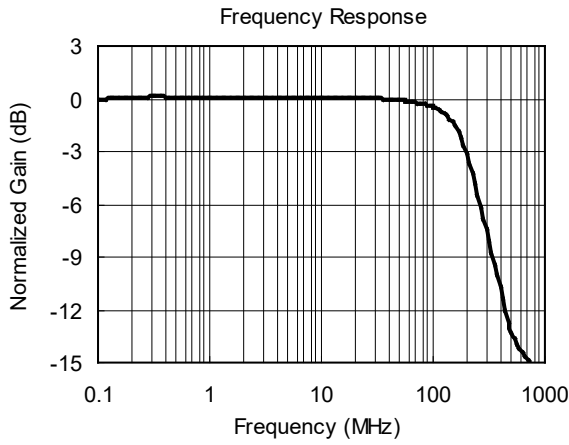

TYPICAL PERFORMANCE CHARACTERISTICS (continued)

At $V_S = +5.0V$, $T_A = +25^\circ C$, $R_L = 150\Omega$, all outputs AC-coupled with $220\mu F$, unless otherwise noted.

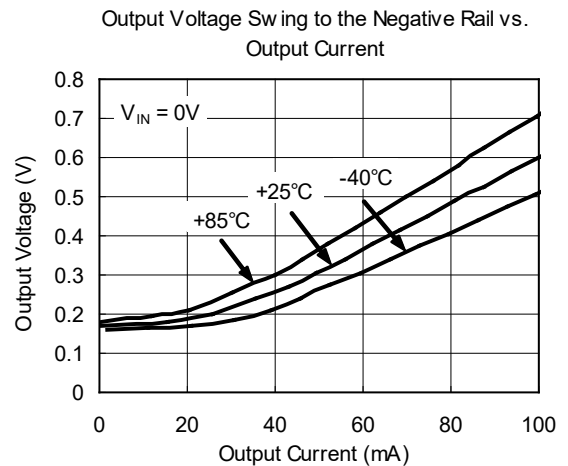
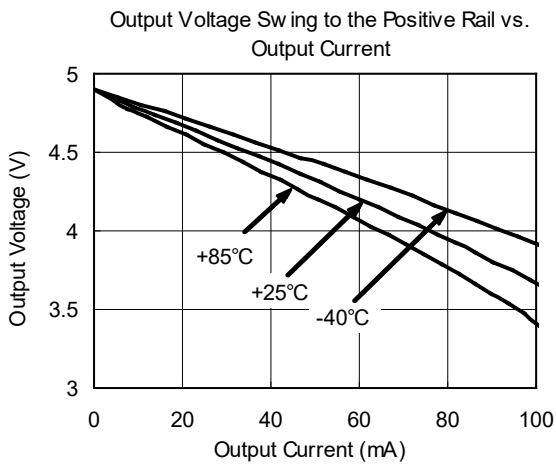
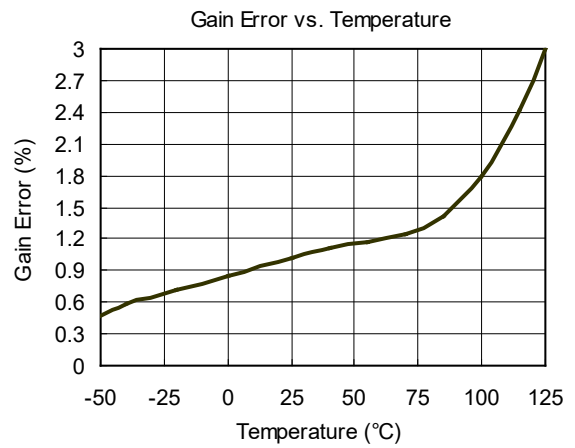
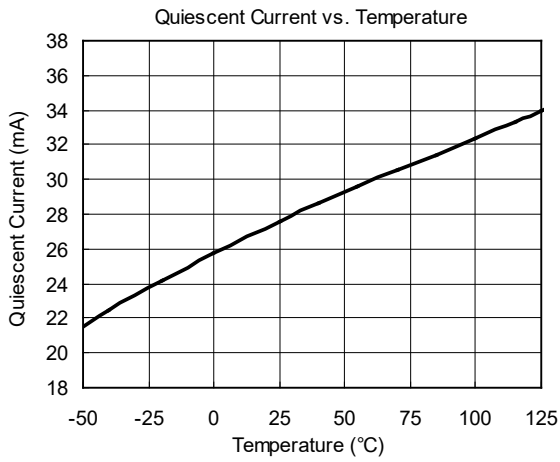
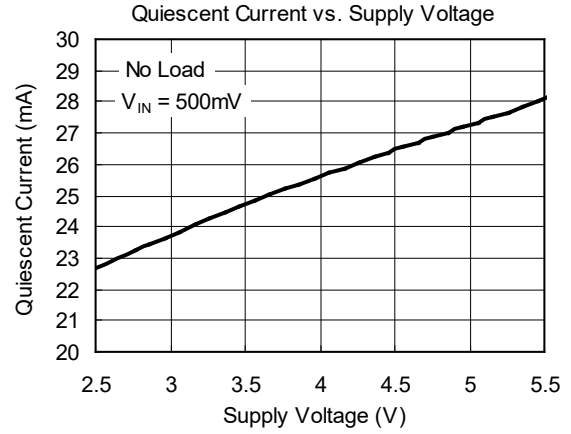
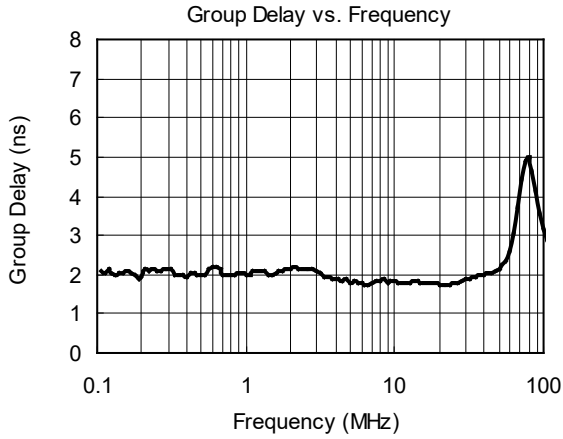

PACKAGE OUTLINE DIMENSIONS

SOIC-8

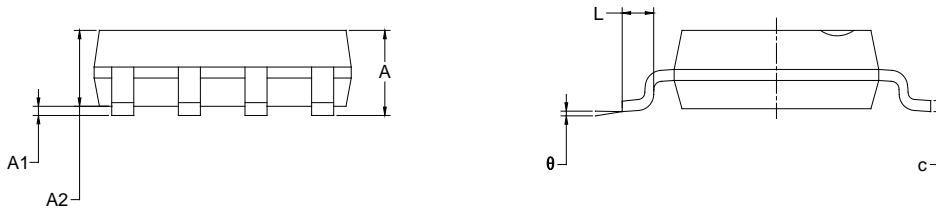
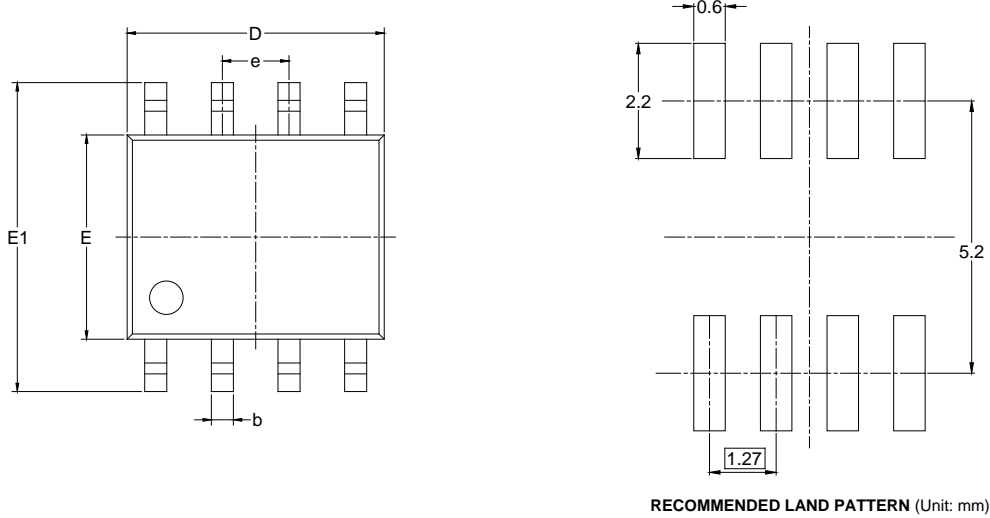

Symbol	Dimensions In Millimeters		Dimensions In Inches	
	MIN	MAX	MIN	MAX
A	1.350	1.750	0.053	0.069
A1	0.100	0.250	0.004	0.010
A2	1.350	1.550	0.053	0.061
b	0.330	0.510	0.013	0.020
c	0.170	0.250	0.006	0.010
D	4.700	5.100	0.185	0.200
E	3.800	4.000	0.150	0.157
E1	5.800	6.200	0.228	0.244
e	1.27 BSC		0.050 BSC	
L	0.400	1.270	0.016	0.050
θ	0°	8°	0°	8°

NOTES:
 1. Body dimensions do not include mode flash or protrusion.
 2. This drawing is subject to change without notice.

PACKAGE INFORMATION

TAPE AND REEL INFORMATION

REEL DIMENSIONS



TAPE DIMENSIONS



NOTE: The picture is only for reference. Please make the object as the standard.

KEY PARAMETER LIST OF TAPE AND REEL

Package Type	Reel Diameter	Reel Width W1 (mm)	A0 (mm)	B0 (mm)	K0 (mm)	P0 (mm)	P1 (mm)	P2 (mm)	W (mm)	Pin1 Quadrant
SOIC-8	13"	12.4	6.40	5.40	2.10	4.0	8.0	2.0	12.0	Q1

DD0001

PACKAGE INFORMATION

CARTON BOX DIMENSIONS



NOTE: The picture is only for reference. Please make the object as the standard.

KEY PARAMETER LIST OF CARTON BOX

Reel Type	Length (mm)	Width (mm)	Height (mm)	Pizza/Carton
13"	386	280	370	5

DD0002