



SGMPM15330

30V, Power, Single P-Channel, TDFN Package, MOSFET

FEATURES

- High-Speed Switching
- Low On-State Resistance
- RoHS Compliant and Halogen Free

APPLICATIONS

Relay Driver Applications
 Load Switch Applications
 High-Speed Line Driver
 Handheld and Mobile Applications
 USB Connector VBUS Power Switch

PRODUCT SUMMARY

$R_{DS(on)}$ (TYP) $V_{GS} = 10V$	$R_{DS(on)}$ (MAX) $V_{GS} = 10V$	I_D (MAX) $T_C = +25^\circ C$
12m Ω	15m Ω	-9A

PIN CONFIGURATION

(TOP VIEW)

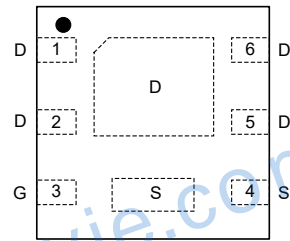

TDFN-2x2-6BL

ABSOLUTE MAXIMUM RATINGS

PARAMETER	SYMBOL	VALUE	UNITS
Drain-to-Source Voltage	V_{DS}	-30	V
Gate-to-Source Voltage	V_{GS}	± 20	V
Drain Current	I_D	$T_A = +25^\circ C$	-9
		$T_A = +70^\circ C$	-7
Drain Current (Pulse) ⁽¹⁾	I_{DM}	-30	A
Total Dissipation	P_D	$T_A = +25^\circ C$	1.6
		$T_A = +70^\circ C$	1
Avalanche Current ⁽²⁾	I_{AS}	-38	A
Avalanche Energy ⁽²⁾	E_{AS}	72.2	mJ
Junction Temperature	T_J	+150	$^\circ C$
Storage Temperature Range	T_{STG}	-55 to +150	$^\circ C$
Lead Temperature (Soldering, 10s)		+260	$^\circ C$

EQUIVALENT CIRCUIT

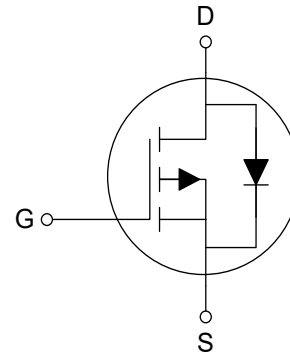

Stresses beyond those listed in Absolute Maximum Ratings may cause permanent damage to the device. Exposure to absolute maximum rating conditions for extended periods may affect reliability.

NOTES:

1. $t_{PLUSE} < 10\mu s$
2. Parts are 100% tested at $V_{GS} = -10V$, $I_L = -26A$, $E_{AS} = 33.8mJ$.

PACKAGE/ORDERING INFORMATION

MODEL	PACKAGE DESCRIPTION	SPECIFIED TEMPERATURE RANGE	ORDERING NUMBER	PACKAGE MARKING	PACKING OPTION
SGMPM15330	TDFN-2x2-6BL	-55°C to +150°C	SGMPM15330TTEN6G/TR	034 XXXX	Tape and Reel, 3000

MARKING INFORMATION

NOTE: XXXX = Date Code, Trace Code and Vendor Code.

YYY — Serial Number

XXXX

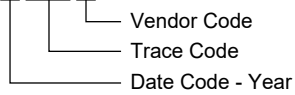

Green (RoHS & HSF): SG Micro Corp defines "Green" to mean Pb-Free (RoHS compatible) and free of halogen substances. If you have additional comments or questions, please contact your SGMICRO representative directly.

DISCLAIMER

SG Micro Corp reserves the right to make any change in circuit design, or specifications without prior notice.

THERMAL RESISTANCE MAXIMUM RATINGS

PARAMETER	SYMBOL	VALUE	UNITS
Junction-to-Ambient Thermal Resistance ⁽¹⁾	R _{θJA}	75	°C/W

NOTE: 1.The device mounted on one square inch of copper pad, 2oz copper on FR4 board.

代理商 威尔迈 www.visvie.com
联系电话 138 2526 5270

ELECTRICAL CHARACTERISTICS

(T_A = +25°C, unless otherwise noted.)

PARAMETER	SYMBOL	CONDITIONS	MIN	TYP	MAX	UNITS	
Static OFF Characteristics							
Drain-to-Source Breakdown Voltage	V _{BR_DSS}	V _{GS} = 0V, I _D = -250μA	-30			V	
Zero Gate Voltage Drain Current	I _{DSS}	V _{GS} = 0V, V _{DS} = -30V			-1	μA	
Gate-to-Source Leakage Current	I _{GSS}	V _{GS} = ±20V, V _{DS} = 0V			±100	nA	
Static ON Characteristics							
Gate-to-Source Threshold Voltage	V _{GS_TH}	V _{GS} = V _{DS} , I _D = -250μA	-1	-1.4	-2	V	
Static Drain-to-Source On-State Resistance	R _{DS(on)}	I _D = -8A	V _{GS} = -10V		12	15	mΩ
			V _{GS} = -4.5V		20	26	
Forward Transconductance	g _{FS}	V _{DS} = -5V, I _D = -8A		20		S	
Diode Characteristics							
Diode Forward Voltage	V _{F_SD}	V _{GS} = 0V, I _S = -1A		-0.7	-1.2	V	
Reverse Recovery Time	t _{RR}	V _{GS} = 0V, I _S = -8A, di/dt = 100A/μs		12.3		ns	
Reverse Recovery Charge	Q _{RR}			4.4		nC	
Dynamic Characteristics							
Input Capacitance	C _{ISS}	V _{GS} = 0V, V _{DS} = -15V, f = 1MHz		1753		pF	
Output Capacitance	C _{OSS}			192			
Reverse Transfer Capacitance	C _{RSS}			168			
Total Gate Charge	Q _G	V _{DS} = -15V, I _D = -8A	V _{GS} = -10V		32	nC	
			V _{GS} = -4.5V		15.5		
Gate-to-Source Charge	Q _{GS}	V _{GS} = -4.5V, V _{DS} = -15V, I _D = -8A		5.2		nC	
Gate-to-Drain Charge	Q _{GD}			5			
Switch Characteristics							
Turn-On Delay Time	t _{D_ON}	V _{GS} = -10V, V _{DS} = -15V, I _D = -8A, R _G = 3Ω		4.8		ns	
Rise Time	t _r			27.7			
Turn-Off Delay Time	t _{D_OFF}			34.7			
Fall Time	t _f			32.2			

TYPICAL PERFORMANCE CHARACTERISTICS

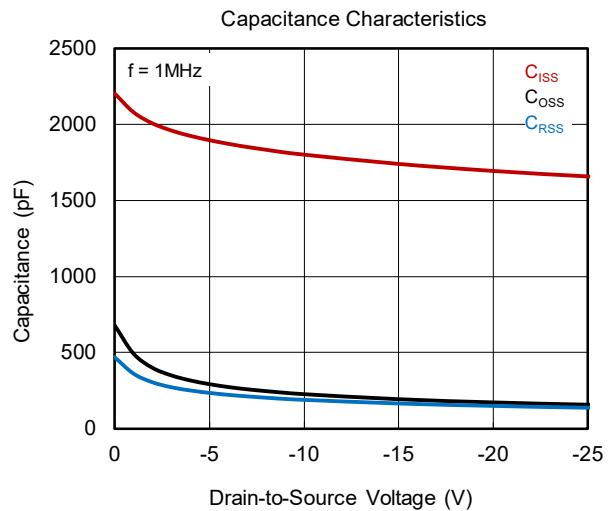
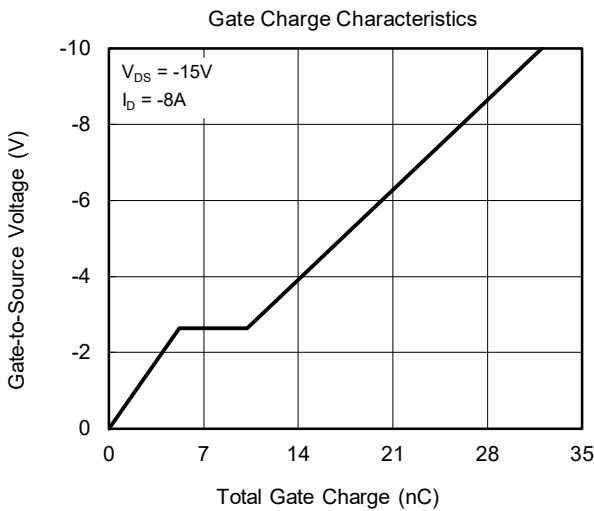
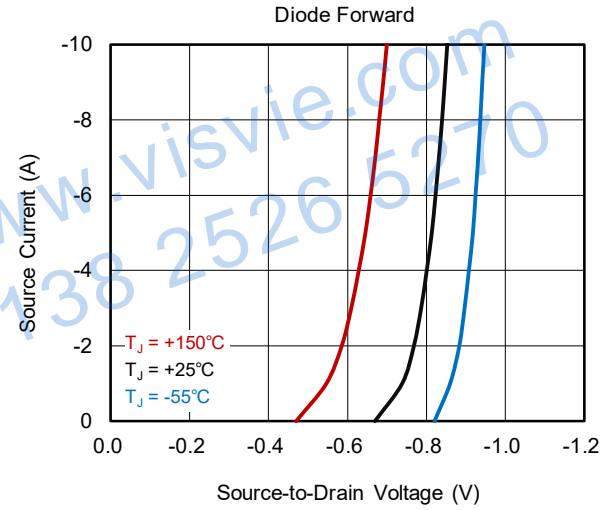
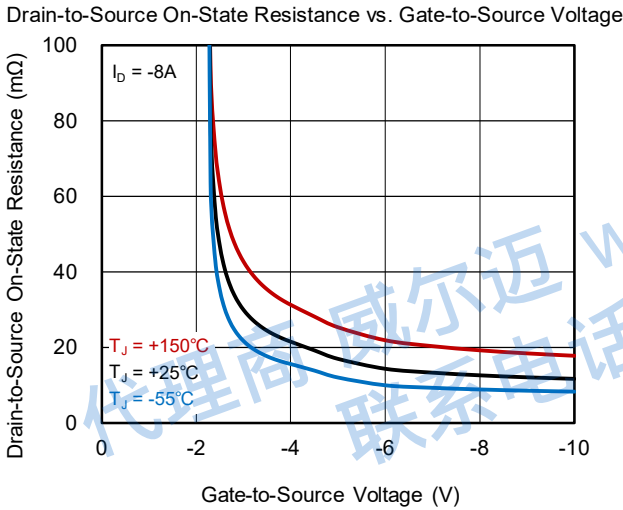
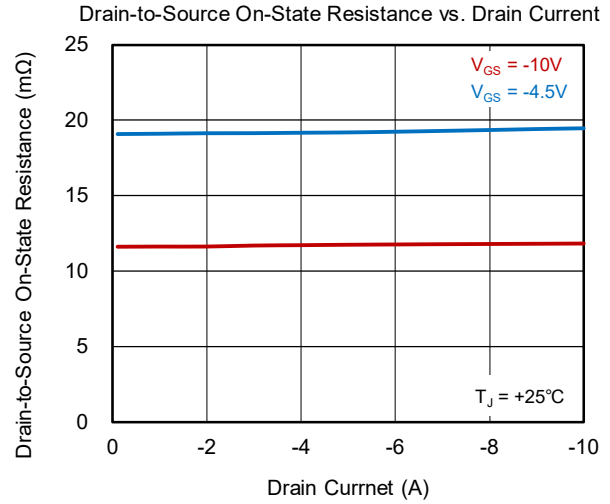
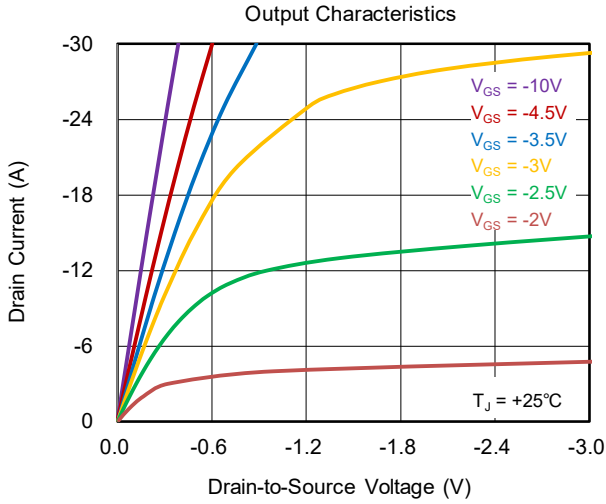

TYPICAL PERFORMANCE CHARACTERISTICS (continued)

Normalized Threshold Voltage vs. Junction Temperature

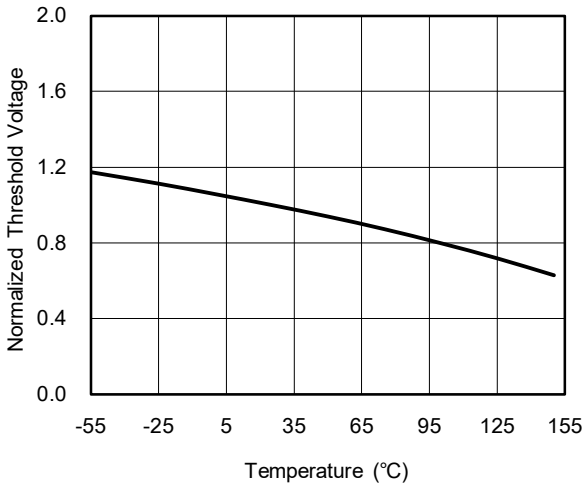

Normalized On-Resistance vs. Junction Temperature

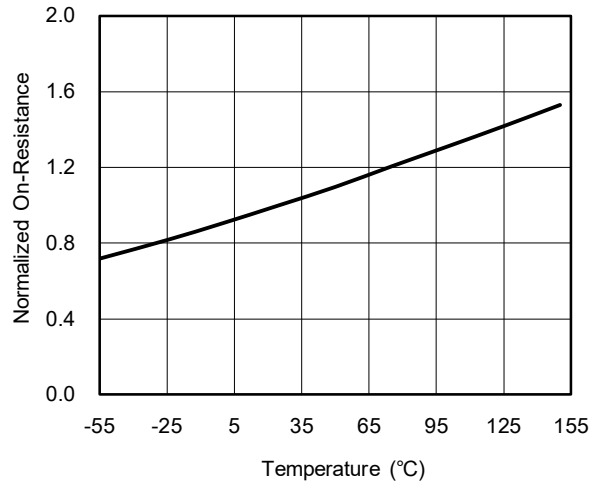

Transfer Characteristics

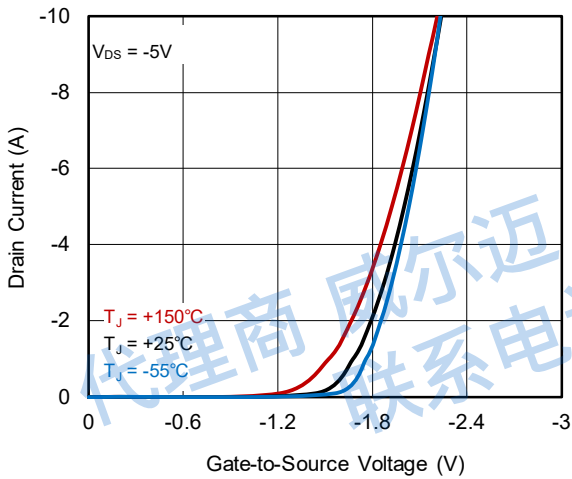

Safe Operating Area

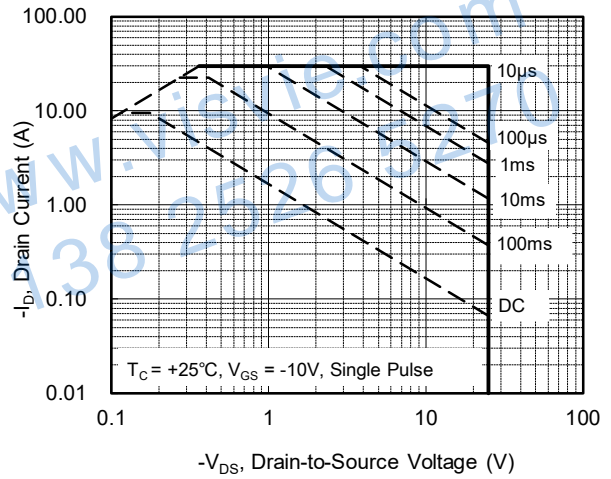

TYPICAL PERFORMANCE CHARACTERISTICS (continued)

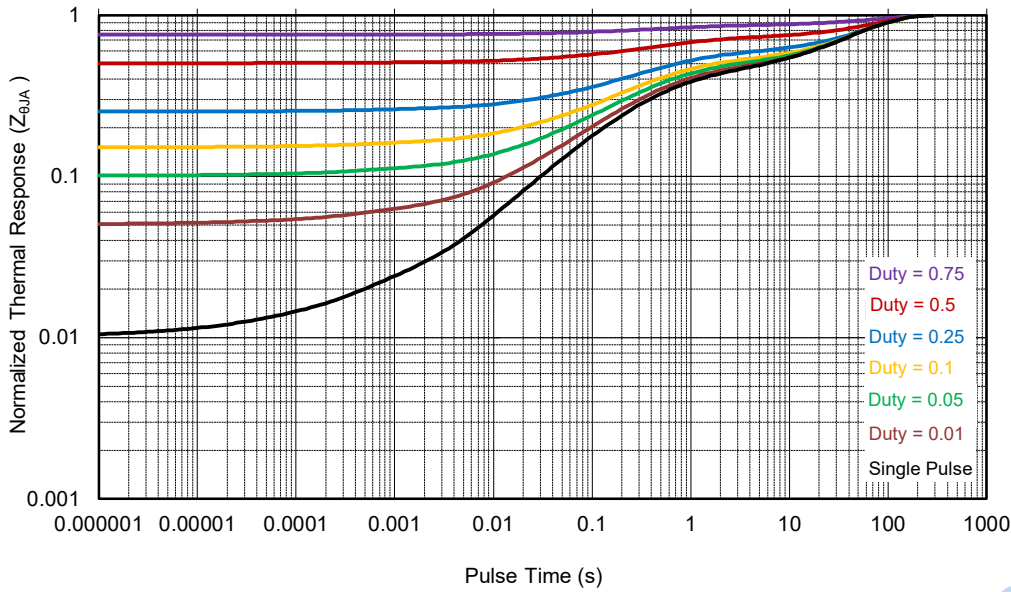

代理商 威尔迈 www.visvie.com
联系电话 138 2526 5270

REVISION HISTORY

NOTE: Page numbers for previous revisions may differ from page numbers in the current version.

Changes from Original (JUNE 2024) to REV.A	Page
Changed from product preview to production data.....	All

PACKAGE OUTLINE DIMENSIONS

TDFN-2x2-6BL

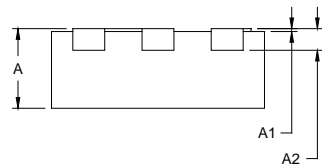
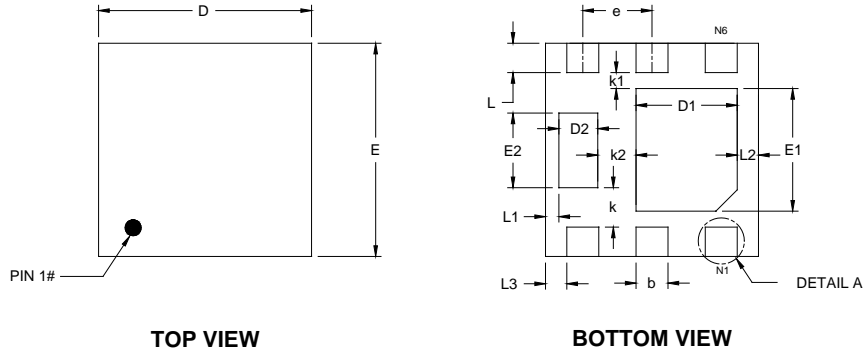

SIDE VIEW

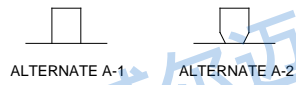

ALTERNATE TERMINAL CONSTRUCTION

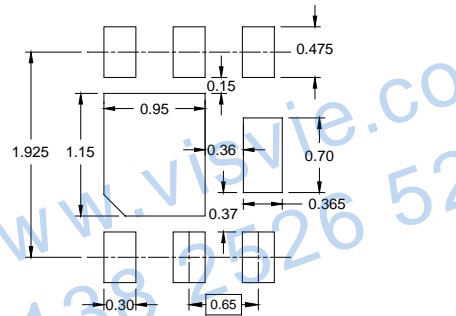

RECOMMENDED LAND PATTERN (Unit: mm)

Symbol	Dimensions In Millimeters		
	MIN	MOD	MAX
A	0.700	0.750	0.800
A1	0.000	0.020	0.050
A2	0.200 REF		
b	0.250	0.300	0.350
D	1.900	2.000	2.100
E	1.900	2.000	2.100
D1	0.850	0.950	1.050
E1	1.050	1.150	1.250
D2	0.315	0.365	0.415
E2	0.650	0.700	0.750
e	0.650 BSC		
k	0.370 REF		
k1	0.150 REF		
k2	0.360 REF		
L	0.225	0.275	0.325
L1	0.125 REF		
L2	0.200 REF		
L3	0.200 REF		

NOTE: This drawing is subject to change without notice.

TAPE AND REEL INFORMATION

REEL DIMENSIONS

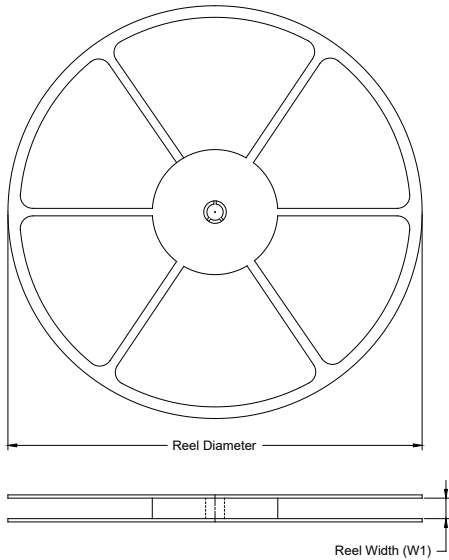

TAPE DIMENSIONS

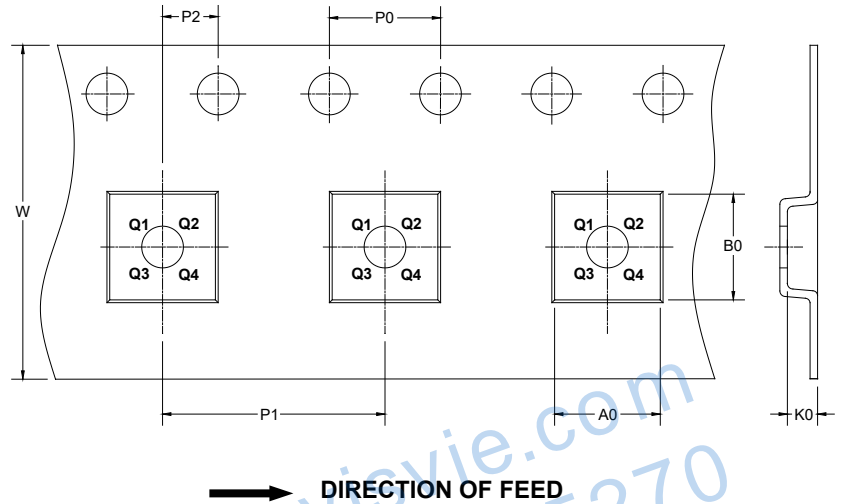

NOTE: The picture is only for reference. Please make the object as the standard.

KEY PARAMETER LIST OF TAPE AND REEL

Package Type	Reel Diameter	Reel Width W1 (mm)	A0 (mm)	B0 (mm)	K0 (mm)	P0 (mm)	P1 (mm)	P2 (mm)	W (mm)	Pin1 Quadrant
TDFN-2×2-6BL	7"	9.5	2.30	2.30	1.00	4.0	4.0	2.0	8.0	Q1

DD0001

PACKAGE INFORMATION

CARTON BOX DIMENSIONS



NOTE: The picture is only for reference. Please make the object as the standard.

KEY PARAMETER LIST OF CARTON BOX

Reel Type	Length (mm)	Width (mm)	Height (mm)	Pizza/Carton
7" (Option)	368	227	224	8
7"	442	410	224	18

DD0002