

深圳市昱申科技有限公司

CHINA YOUNG SUN LED TECHNOLOGY CO., LTD.

TEL: (86) 755-28079401 28079402 28079403 28079404 28079405

FAX: (86) 755-28079407 E-mail: info@100LED.com Web: www.100LED.com

Model No.: YSD-439AK2B-35

Applications:

- Moving Message Display
- Full Color Display
- Banking Board
- Score Boards
- Digital Display

LED Chip Absolute Maximum Ratings: (Ta=25 °C)

Parameter	Symbol	Red	Unit
Forward current	I _F	20	mA
Peak forward current (Duty Cycle = $\frac{1}{10}$, 10KHz)	I _{PF}	30	mA
Reverse voltage (V _R =5V)	I _R	10	μA
Operating temp	T _{OPR}	-25 - 85	°C
Storage temp	T _{STG}	-30 - 85	°C
Peak Emission Wavelength	λ _{PH}	572.5	nm

* Soldering Bath: not more than 5 seconds @260 °C. The bottom ends of the plastic reflector should be at least 2mm above the solder surface

Soldering Iron: not more than 3 seconds @300 °C under 30W

LED Chip Typical Electrical & Optical Characteristics: (Ta=25 °C)

ITEMS	Symbol	Condition	Min.	Typ.	Max.	Unit
Forward Voltage	V _F	I _F =20mA	2.0	2.1	2.2	V
Luminous Intensity	I _v	I _F =20mA	50	55	60	mcd
Wavelength	Δλ	I _F =20mA	570	572.5	573	nm
Light Degradation after 1000 hours			-4.68% ~ -8.27%			

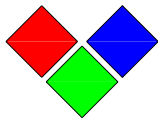

深圳市昱申科技有限公司

CHINA YOUNG SUN LED TECHNOLOGY CO., LTD.

TEL: (86) 755-28079401 28079402 28079403 28079404 28079405

FAX: (86) 755-28079407 E-mail: info@100LED.com Web: www.100LED.com

Mechanical Dimensions:

- . All dimension are in mm, tolerance is $\pm 0.2\text{mm}$ unless otherwise noted
- . An epoxy meniscus may extend about 1.5mm down the leads.

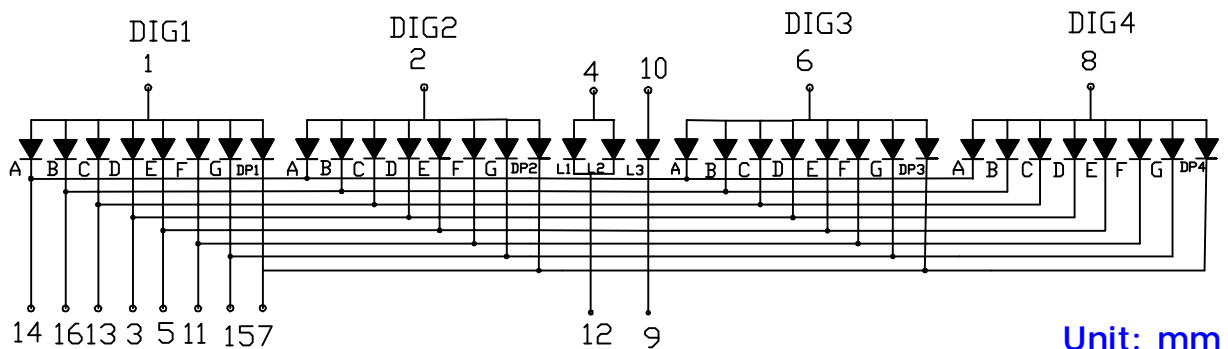
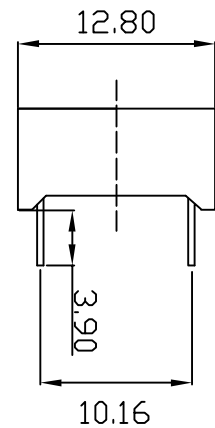
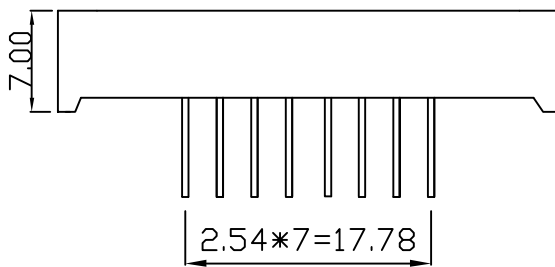
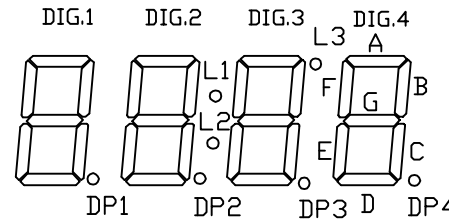
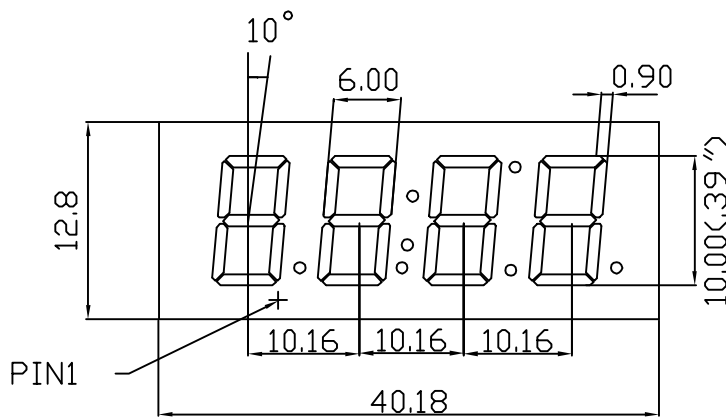

Unit: mm

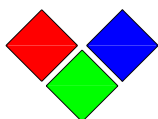

深圳市昱申科技有限公司

CHINA YOUNG SUN LED TECHNOLOGY CO., LTD.

TEL: (86) 755-28079401 28079402 28079403 28079404 28079405

FAX: (86) 755-28079407 E-mail: info@100LED.com Web: www.100LED.com

Code System:

YSM-439AXXA-35

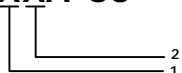

. 1. Color:

R: Red A: Amber K: Kelly Y: Yellow
G: Green C: Cyan P: Purple W: White

. 2. Wavelength or Color Temperature Range:

R1: 620-625nm	K1: 565-570nm	C1: 495-497.5nm	B3: 460-462.5nm	P1: 375-380nm
R2: 625-630nm	K2: 570-573nm	C2: 497.5-500nm	B4: 462.5-465nm	P2: 390-395nm
R3: 630-635nm	G1: 515-517.5nm	C3: 500-502.5nm	B5: 465-467.5nm	P3: 395-400nm
R4: 635-640nm	G2: 517.5-520nm	C4: 502.5-505nm	B6: 467.5-470nm	P4: 400-405nm
R5: 640-645nm	G3: 520-522.5nm	C5: 505-507.5nm	B7: 470-472.5nm	P5: 405-410nm
A1: 600-605nm	G4: 522.5-525nm	C6: 507.5-510nm	B8: 472.5-475nm	W1: 9000-11000
A2: 605-610nm	G5: 525-527.5nm	C7: 510-512.5nm		W2: 6000-8000K
Y1: 584-587nm	G6: 527.5-530nm	C8: 512.5-515nm		W3: 2700-4000K
Y2: 587-590nm	G7: 530-532.5nm	B1: 455-457.5nm		
Y3: 590-593nm	G8: 532.5-535nm	B2: 457.5-460nm		

Warrantee:

- . 3 years warrantee for our red, yellow, amber and kelly items based on no more than hours continously lighting per day.
- . 2 years warrantee for our Blue, Green, Cyan and Purple items based on no more than hours continously lighting per day.
- . 1 years warrantee for our Cool White, Pure White and Warm White items based on no more than 8 hours continously lighting per day.
- . Electrical & Optical Characteristics consistency of same items all shipments.

Notes:

- . Please use Digital Display based on our datasheet.
- . Digital Display is sensitive to statics, be sure your equipments are anti-static when you use our Dot Matrixs.
- . Pay more attention to your heat dissipation system when you use it, the better heat dissipation, the longer Digital Display lifespan.