



# MICROWAVE SILICON COMPONENTS

---

## CONTENTS

---



Spirit of New  
Technology

**PAGE**

▶ <u>INTRODUCTION / SYMBOLS</u> .....	<u>12-2</u>
▶ <u>SILICON PIN DIODES</u> .....	<u>12-4</u>
▶ <u>SCHOTTKY DIODES</u> .....	<u>12-28</u>
▶ <u>TUNING VARACTORS DIODES</u> .....	<u>12-31</u>
▶ <u>POWER GENERATION DIODES</u> .....	<u>12-40</u>
▶ <u>CASE STYLES</u> .....	<u>12-47</u>
▶ <u>MOS CAPACITORS: Please consult page 7-39 of this catalog</u>	

## Introduction



# ▶ INTRODUCTION

This part of the Microwave section presents TEMEX product lines including:

- receiving diodes
- control diodes
- tuning varactors
- multiplier varactors
- step recovery diodes
- high voltage PIN diodes

TEMEX products are available in a complete assortment of packages including:

- chips
- standard
- surface mount ceramic and plastic
- non magnetic
- custom

## *IN-HOUSE PRODUCTION*

The silicon slice is the in-house starting point of TEMEX product manufacturing. From the virgin wafer, TEMEX performs all functions, including:

- epitaxy
- diffusion
- photomasking
- metallization
- passivation
- dicing
- packaging
- control and burn-in

TEMEX uses and controls ten separate silicon-related technologies, e.g. all Schottky metallurgies, all junction passivations, and all mesa operations.

**SYMBOLS**

$C_b$	.....	Case Capacitance
$C_j$	.....	Junction Capacitance
$C_T$	.....	Total Capacitance
$C_x/C_y$	.....	Tuning Ratio
$f$	.....	Test Frequency
$F_{CO}$	.....	Cut-off Frequency
$F_I$	.....	Frequency Input
$F_{IF}$	.....	Intermediate Frequency
$F_O$	.....	Output Frequency
$F_{oper}$	.....	Operating frequency
$I_F$	.....	Forward Continuous Current
$I_R$	.....	Reverse Continuous Current
$I_{RP}$	.....	Reverse Pulse Current
$L$	.....	Conversion Loss
N/A	.....	Not Applicable
$NF_{SSB}$	.....	Single Sideband Noise Figure
$NF_{IF}$	.....	Noise Figure of Intermediate Frequency
$\varnothing$	.....	Gold Contact Diameter
$P_{CW}$	.....	CW Power Capability
$P_{diss}$	.....	Power Dissipation
$P_{in}$	.....	Power Input
$P_L$	.....	Limiting Threshold
$P_{LO}$	.....	Local Oscillator Power
$P_O$	.....	Output Power
$P_{RF}$	.....	RF Power
$Q_{-X}$	.....	Figure of Merit
$R_{SF}$	.....	Forward Series Resistance
$R_{th}$	.....	Thermal Resistance
$R_V$	.....	Video Resistance
$\tau_I$	.....	Minority Carrier Lifetime
$T_{CR}$	.....	Reverse Switching Time
$T_j$	.....	Junction Temperature
$t_{SO}$	.....	Snap-off Time
$T_{SS}$	.....	Tangential Sensitivity
$V_{BR}$	.....	Breakdown Voltage
$V_F$	.....	Forward Continuous Voltage
$V_R$	.....	Applicable Voltage (RF + bias)
VSWR	.....	Voltage Standing Wave Ratio
$V_T$	.....	Forward Threshold Voltage
$V_{TO}$	.....	Threshold Voltage
$Z_{IF}$	.....	Impedance at Intermediate Frequency
$Z_O$	.....	Output Impedance

Selection guide

 **SILICON PIN DIODES****Selection Guide**PAGE**HOW TO SPECIFY A PIN DIODE?** **12-5****SURFACE MOUNT PACKAGE**

- **PLASTIC PACKAGE SWITCHING SILICON PIN DIODES** **12-6**
- **PLASTIC PACKAGE ATTENUATING SILICON PIN DIODES** **12-8**
- **LOW COST SQUARE CERAMIC PACKAGE PIN DIODES** **12-10**
- **SQUARE CERAMIC PIN DIODES** **12-12**
- **NON MAGNETIC SQUARE CERAMIC PACKAGE 500 V PIN DIODES** **12-15**

**HIGH VOLTAGE PIN DIODES** **12-17**

- **SWITCHING & PHASE SHIFTING APPLICATIONS** **12-18**
- **TWO AND THREE PORTS RF PIN SWITCH MODULES** **12-20**

**MICROWAVE APPLICATIONS** **12-22**

- **ULTRAFAST SWITCHING SILICON PIN DIODES** **12-23**
- **FAST SWITCHING SILICON PIN DIODES** **12-24**
- **ATTENUATOR SILICON PIN DIODES** **12-25**
- **SILICON LIMITER PIN DIODES** **12-26**



## HOW TO SPECIFY A PIN DIODE ?

To obtain the PIN diodes best suited for a specific application, consider the following:

### 1. *Application*

- switch
- attenuator
- limiter

### 2. *Frequency and bandwidth requirements*

### 3. *Power characteristics*

- peak
- average
- pulse duration and duty cycle

### 4. *Switching time*

### 5. *Bias conditions*

- forward
- reverse

### 6. *Circuit impedance*

### 7. *Shunt or series assembly*

### 8. *Maximum loss expected*

### 9. *Minimum isolation needed*

### 10. *VSWR and distortion requirements*

### 11. *Power applied to the diode*

- forward biased
- reverse biased
- during switching

### 12. *Static characteristics*

- applicable voltage:  $V_R$
- total capacitance:  $C_T$   
(in space charge)
- forward series resistance:  $R_{SF}$
- carrier lifetime  $\tau_I$
- thermal resistance:  $R_{th}$

### 13. *Mechanical and packaging constraints*

Plastic package Surface Mount switching silicon PIN diodes



## PLASTIC PACKAGE SURFACE MOUNT SWITCHING SILICON PIN DIODES

### *Description*

TEMEX uses its proprietary technology to manufacture its Silicon PIN diodes in plastic package.

This product family is designed for a low cost, medium to high volume market that may be supplied in tape and reel for automated pick and place assembly on surface mount circuit boards.

The use of this technology eliminates wire bonding on to the chips.

### *Applications*

The DH50XXX series PIN diodes are offered in a large selection of capacitance range (.3 pF to 1.2 pF) and breakdown voltage (35 V to 200 V). They provide low loss (low series resistance), low switching time and low switching current.

TEMEX' diodes are designed to cover a broad range of CW low power (up to 2 W), medium peak power, RF and microwave applications (up to 3 GHz).

Main applications include: SPST and SPDT switches, antenna (Wireless Communication Systems) and filter switches, phase shifters ....

**Note:** To reduce the distortion, it is necessary to verify and design with the following formula:

$$\frac{\hat{I}_{HF}}{\pi\tau_1 I_{DC} F} \ll 1$$

- $\hat{I}_{HF}$  : RF peak current (A)
- $\tau_1$  : Diode minority carrier lifetime (s)
- $I_{DC}$  : DC bias current (A)
- $\pi F$  : Application frequency (Hz)

Plastic package Surface Mount switching silicon PIN diodes

*Characteristics @ Ta = +25° C*

PACKAGED DIODES				
	Breakdown voltage ( $V_{BR}^{(1)}$ )	Total capacitance ( $C_T^{(2)}$ )	Series resistance ( $R_{SF}$ )	Minority carrier lifetime ( $\tau_I$ )
Test conditions	$I_R = 10 \mu A$	$F = 1 \text{ MHz}$ $V_R = 50 \text{ V}$	$I_F = 10 \text{ mA}$ $F = 120 \text{ MHz}$	$I_F = 10 \text{ mA}$ $I_R = 6 \text{ mA}$
Type	V min.	pF max	$\Omega$ max	ns typ.
DH50051	35	0.3 <sup>(3)</sup>	2.5 <sup>(5)</sup>	150
DH50058	35	1 <sup>(3)</sup>	0.5	200
DH50053	50	0.35 <sup>(4)</sup>	1.5	200
DH50103	100	0.35	3	500
DH50109	100	1.2	0.6	1000
DH50203	200	0.35	3	500
DH50209	200	1.2	0.6	1000
DH80051	400	0.6	2	2000

- (1) : Other breakdown values on request
- (2) : Other capacitance values on request
- (3) :  $V_R = 5 \text{ V}$  at  $F = 1 \text{ MHz}$
- (4) :  $V_R = 20 \text{ V}$  at  $F = 1 \text{ MHz}$
- (5) :  $R_{SF}$  at  $I_F = 5 \text{ mA}$

*Temperature ranges:*

Operating junction ( $T_j$ ) : -55° C to +125° C      Storage : -55° C to +150° C

*Packages*

Packages	SOD323	SOT23	SOT23	SOT23	SOT143
DH50051	DH50051-60	DH50051-51	DH50051-53	DH50051-54	DH50051-70
DH50058	DH50058-60	DH50058-51	DH50058-53	DH50058-54	DH50058-70
DH50053	DH50053-60	DH50053-51	DH50053-53	DH50053-54	DH50053-70
DH50103	DH50103-60	DH50103-51	DH50103-53	DH50103-54	DH50103-70
DH50109	DH50109-60	DH50109-51	DH50109-53	DH50109-54	DH50109-70
DH50203	DH50203-60	DH50203-51	DH50203-53	DH50203-54	DH50103-70
DH50209	DH50209-60	DH50209-51	DH50209-53	DH50209-54	DH50209-70
DH80051	DH80051-60	DH80051-51	DH80051-53	DH80051-54	DH80051-70

(1) Other configuration available on request.

*How to order?*

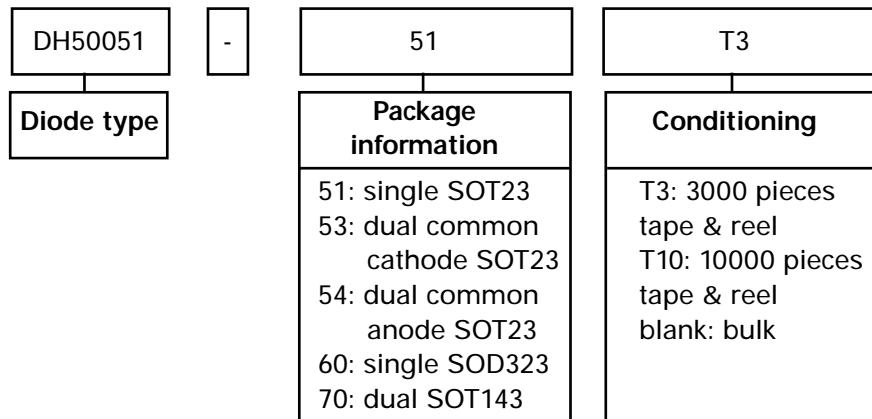

Plastic package Surface Mount attenuating silicon PIN diodes



## PLASTIC PACKAGE SURFACE MOUNT ATTENUATING SILICON PIN DIODES

### Description

TEMEX uses its proprietary technology to manufacture its Silicon PIN diodes in plastic package.

This product family is designed for a low cost, medium to high volume market that may be supplied in tape and reel for automated pick and place assembly on surface mount circuit boards. The use of this technology eliminates wire bonding on to the chips.

### Applications

Typical applications include variable RF attenuators and AGC (Automatic Gain Control) circuits, from MHz to several GHz.

The attenuating Pin diode uses properties of variation of forward series resistance versus the DC forward bias current. In order to obtain the best dynamic range, a single diode attenuator may be used in series or shunt configuration or designed as a multiple diode circuit (T or p circuit), where the device may be matched through the attenuation range.

**Note:** To reduce the distortion, it is necessary to verify and design with the following formula:

$$\frac{\hat{I}_{HF}}{\pi\tau_1 I_{DC} F} \ll 1$$

- $\hat{I}_{HF}$  : RF peak current (A)
- $\tau_1$  : Diode minority carrier lifetime (s)
- $I_{DC}$  : DC bias current (A)
- F : Application frequency (Hz)

### Typical performance curve

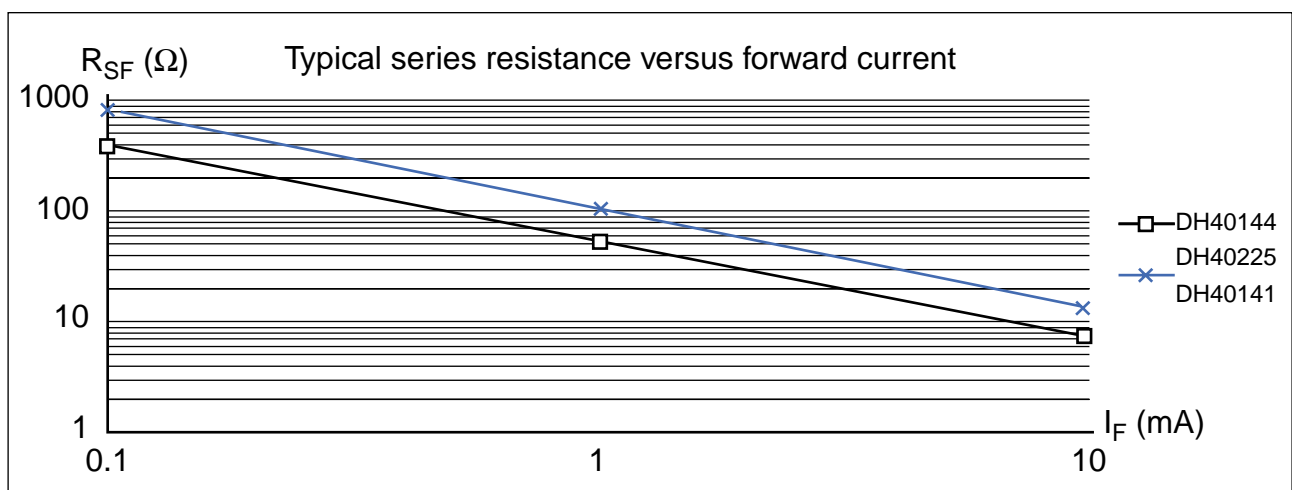



Plastic package Surface Mount attenuating silicon PIN diodes



Electrical characteristics at 25° C

Electrical Parameters	I Zone thickness (1)	Forward series resistance Rsf (Ω)						Junction capacitance C <sub>j</sub> (2)		Reverse current I <sub>R</sub>	Carrier lifetime τ <sub>i</sub>
Test conditions	μm	F = 120 MHz						F = 1 MHz		V <sub>R</sub> = 100 V	I <sub>F</sub> = 10 mA I <sub>R</sub> = 6 mA
Type	typ.	I <sub>F</sub> = 0.1 mA		I <sub>F</sub> = 1 mA		I <sub>F</sub> = 10 mA		pF		μA	μs
		min.	max	min.	max	min.	max	typ.	max	max	typ.
DH40141	140	400	800	50	100	6.5	13	0.05	0.10	10	2.5
DH40144	140	200	400	25	50	3.5	7	0.10	0.30	10	5.0
DH40225	220	400	800	50	100	6.5	13	0.10	0.30	10	7.0

- (1) Other I zone thicknesses on request
- (2) Other capacitance values on request (measured at 50 V)

Temperature ranges:

Operating junction (T<sub>j</sub>) : - 55° C to + 125° C  
 Storage : - 65° C to + 150° C

Packages

Packages	SOD323	SOT23	SOT143
DH40141	DH40141-60	DH40141-51	DH40141-70
DH40144	DH40144-60	DH40144-51	DH40144-70
DH40225	DH40225-60	DH40225-51	DH40225-70

(1) Other configuration available on request.

How to order?

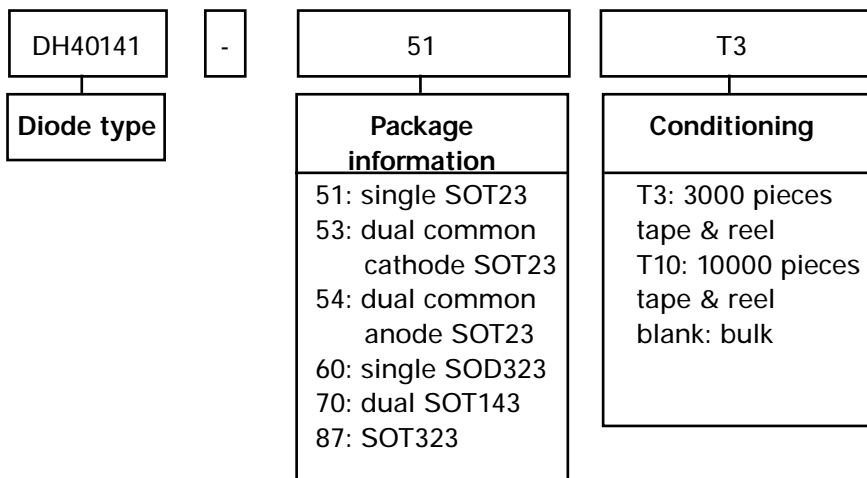

Low cost square ceramic package PIN diodes



## LOW COST SQUARE CERAMIC PACKAGE PIN DIODES

### Features

- Low loss, low distortion
- Low inductance
- High reliability
- Hermetically sealed package
- Non rolling MELF design
- Pick and place compatibility

### Description

TEMEX is manufacturing a square PIN diode for surface mount applications. The chip inside is passivated to ensure high reliability and very low leakage current. These diodes ensure high power switching at frequencies from HF to few GHz. This package utilizes ceramic package technology with low inductance and leadless faced package. The design simplifies automatic pick and place indexing and assembly. The termination contacts are tin plated for vapor or reflow circuit board soldering. The active area is a PIN glass passivated chip, which can be designed to customer specifications.

### Pinning

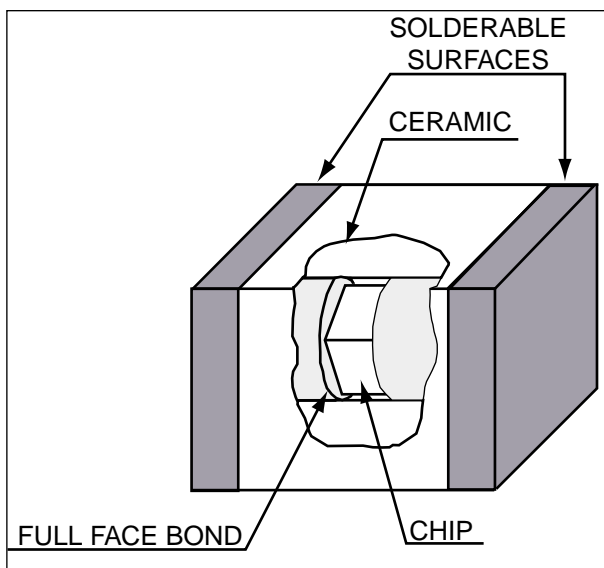

### Outline drawing

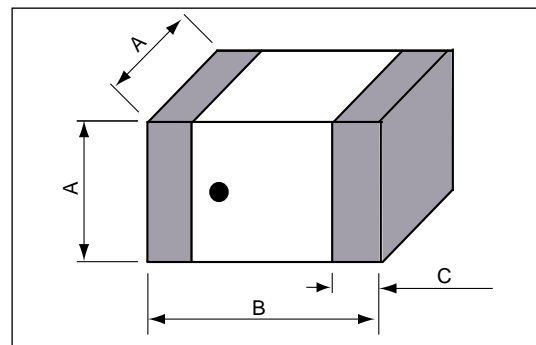

Package	Symbol	Millimeters		Inches	
		min.	max	min.	max
SMD4	A	2	2.3	.079	.091
	B	2.9	3.5	.114	.138
	C	0.3	0.8	.012	.031
SMD6	A	2.5	2.8	.098	.0110
	B	4.7	5.2	.185	.205
	C	0.3	0.8	.012	.031
SMD8	A	3.50	3.81	.138	.150
	B	4.70	5.2	.185	.205
	C	0.20	0.38	.008	.015

## Low cost square ceramic package PIN diodes

*Applications*

TEMEX square ceramic diodes are particularly suitable for high volume tape and reel assembly. Several values of total capacitance are available, together with a low forward series resistance. These components are designed to meet the low distortion specification required by all the mobile radio applications. Due to the specific design, these devices offer low loss and low thermal resistance performance and are characterized for high power handling. The electrical properties are ideal for use in antenna switches, filters, phase shifters, in all mobile radio applications from few MHz to GHz frequencies.

*Electrical characteristics at 25° C*

Electrical Parameter	Package	Applicable voltage V	Total capacitance $C_T$		Forward series resistance $R_{SF}$		Minority carrier lifetime $\tau_I$	Power dissipation
Test conditions		$I_R < 10 \mu A$	f = 1 MHz $V_R = 50 V$		f = 120 MHz $I_F = 50 mA$		$I_F = 10 mA$ $I_R = 6 mA$	Contact surface (1)
Type	Type	V	pF		$\Omega$		$\mu s$	W
		max	typ.	max	typ.	max	min.	max
SQM1050	SMD4 (2)	50	0.6	0.7	0.70	0.90	1.0	3.0
SQM1150	SMD4	200	1.0	1.2	0.25	0.35	1.0	3.0
SQM1250	SMD4	50	0.9	1.2	0.50	0.75	2.0	4.0
SQM1350	SMD4 (2)	50	1.5	1.7	0.40	0.60	3.5	4.5
SQM1450	SMD8	50	1.8	2.5	0.50	0.75	5.0	8.0
SQM2050	SMD4	50	0.6	0.7	0.7	1.00	1.0	3
SQM2150	SMD4	50	1.0	1.2	0.25	0.35	1.0	3

New!

(1) diode brazed on infinite copper heat sink at 25° C

(2) standard package SMD4 also available in SMD6

*Temperature ranges:*

Operating junction ( $T_j$ ) : -55° C to +150° C

Storage : -65° C to +150° C

Soldering : 230° C 5 Sec.

Square ceramic surface mountable PIN diodes



## SQUARE CERAMIC SURFACE MOUNTABLE PIN DIODES

### Description

These PIN diodes are manufactured in a square package (SMD) for surface mount applications. These packages utilize ceramic package technology with low inductance and axial terminations. This design simplifies automatic pick and place indexing and assembly. The termination contacts are tin lead plated for vapor or reflow circuit board soldering on Printed Circuit Boards.

These diodes are particularly suited for applications in frequency hopping radios, low loss, low distortion, and filters in HF, VHF and UHF frequencies.

### Packages

Packages	SMD4	SMD4AM	SMD6	SMD8	SMD8AM
DH50209	-06	-40			
DH80050	-06	-40			
DH80051	-06	-40			
DH80052	-06	-40			
DH80053	-06	-40			
DH80054	-06	-40			
DH80055	-06	-40	-20		
DH80082	-06	-40	-20		
DH80100	-06	-40	-20		
DH80102			-20	-24	-44
DH80106				-24	-44

Other specifications available on request.

### How to order?

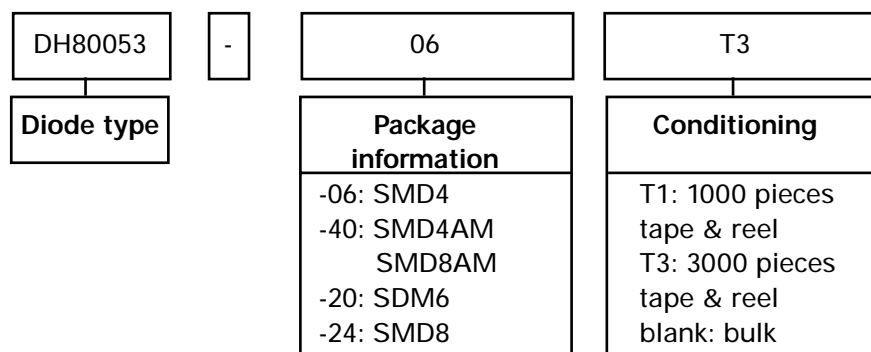

## Square ceramic surface mountable PIN diodes

*Electrical characteristics**Low voltage PIN diodes*

	Breakdown $V_{br}$ (V)	Total capacitance $C_t$ (pF)		Forward series resistance $R_{sf}$ ( $\Omega$ )	Minority carrier $\tau_I$ ( $\mu s$ )
Test conditions	$I_r = 10 \mu A$	$V_r = 50 V$ $f = 1 MHz$		$I_f = 50 mA$ $f = 120 MHz$	$I_f = 10 mA$ $I_r = 6 mA$
Type	min.	typ.	max.	max.	min.
DH50209	200	1.00	1.20	0.25	2.00

*Medium voltage PIN diodes*

	Applicable voltage V (V)	Breakdown $V_{br}$ (V)	Total capacitance $C_t$ (pF)		Forward series resistance $R_{sf}$ ( $\Omega$ )		Minority carrier $\tau_I$ ( $\mu s$ )	Max. power dissipation 25° C	
Test conditions	$I < 10 \mu A$	$I_r = 10 \mu A$	$V_r = 50 V$ $f = 1 MHz$		$I = 100 mA$ $f = 120 MHz$	$I = 200 mA$ $f = 120 MHz$	$I_f = 10 mA$ $I_r = 6 mA$	Contact surface	Free air
Type	max.	typ.	typ.	max.	max.		min.	W (1)	W (2)
DH80050	500	550	0.40	0.45	0.70	0.65	1.1	3.0	1.2
DH80051	500	550	0.55	0.65	0.60	0.55	1.5	3.5	1.2
DH80052	500	550	0.85	1.05	0.40	0.35	2.0	4.0	1.2
DH80053	500	550	1.05	1.20	0.35	0.30	2.5	4.0	1.5
DH80054	500	550	1.25	1.35	0.30	0.27	3.0	4.5	1.5
DH80055	500	550	1.45	1.55	0.28	0.25	3.5	4.5	1.5

- (1) Diode brazed on infinite copper heat sink
- (2) Diode brazed on Epoxy circuit (PCB)

## Square ceramic surface mountable PIN diodes

*Medium voltage PIN diodes*

Test conditions	Applicable voltage V (V)	Breakdown Vbr (V)	Total capacitance Ct (pF)		Forward series resistance Rsf ( $\Omega$ )		Minority carrier $\tau_l$ ( $\mu$ s)	Max. power dissipation 25° C	
	I < 10 $\mu$ A	Ir = 10 $\mu$ A	Vr = 50 V f = 1MHz		I=100mA f=120MHz	I=200 mA f=120 MHz	If=10mA Ir=6mA	Contact surface	Free air
Type	max.	typ.	typ.	max.	max.		min.	W (1)	W (2)
DH80082	800	850	0.90	1.00	0.40	0.35	3.00	TBD	TBD
DH80100	1000	1100	0.55	0.65	0.70	0.60	3.00	TBD	TBD
DH80102	1000	1100	0.85	1.00	0.50	0.35	4.00	TBD	TBD
DH80106	1000	1100	1.25	2.00	0.35	0.30	7.00	TBD	TBD

- (1) Diode brazed on infinite copper heat sink
- (2) Diode brazed on Epoxy circuit (PCB)

*Temperature ranges*

Operating junction ( $T_j$ ) : -55° C to +150° C  
 Storage : -65° C to +150° C

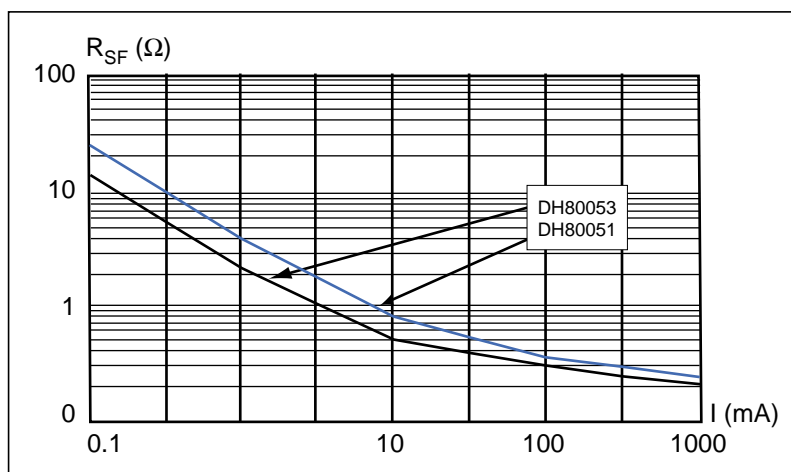
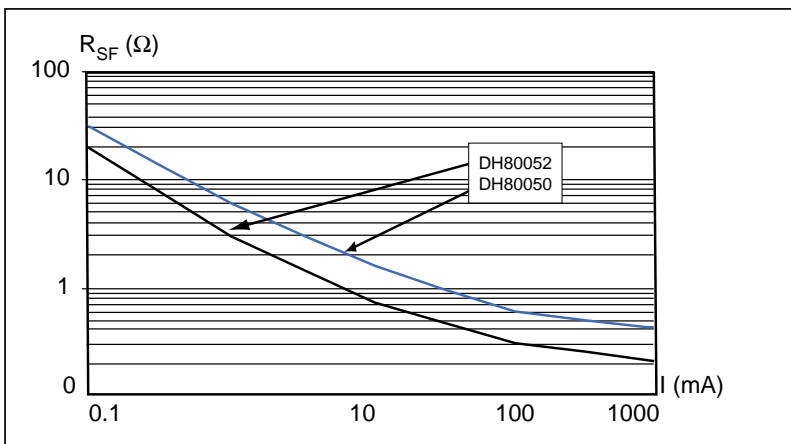
*Series Resistance vs. Forward Current*

Non magnetic square ceramic package 500 volts PIN diodes

## NON MAGNETIC SQUARE CERAMIC PACKAGE 500 VOLTS PIN DIODES

### Features

- Non magnetic package
- Low loss, low distortion
- Low inductance
- High reliability
- Hermetically sealed package
- Glass passivated PIN diode chip
- Non rolling MELF design
- Pick and place compatibility

### Description

TEMEX is manufacturing a non magnetic square PIN diode for surface mount applications. The properties of non magnetism prevent interference in the magnetic field of the imaging system. The chip inside is passivated to ensure high reliability and very low leakage. These diodes ensure high power switching at frequencies from 1 MHz to several GHz. This package utilizes ceramic package technology with low inductance and axial terminations. The design simplifies automatic pick and place indexing and assembly. The termination contacts are tin plated for vapor or reflow circuit board soldering. The active area is a PIN high power glass passivated chip which can be designed to customer specifications.

### Pinning

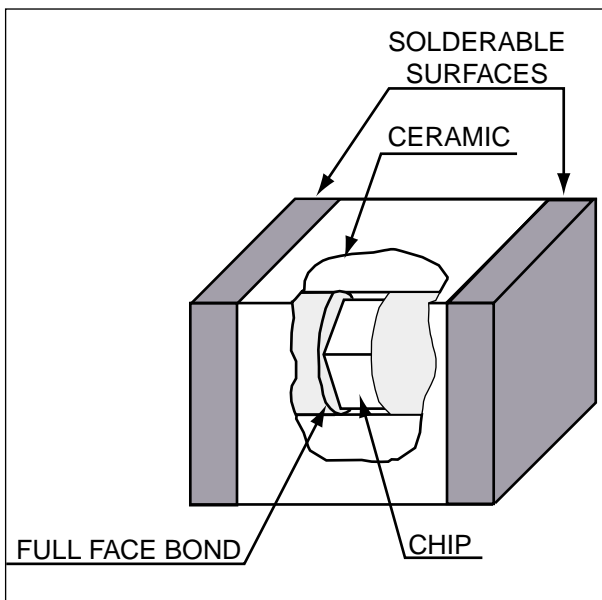

### Outline drawing

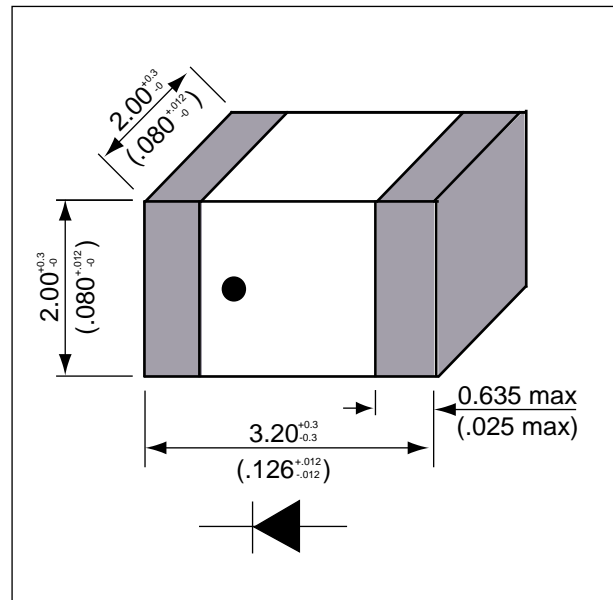

## Non magnetic square ceramic package 500 volts PIN diodes

**Applications**

TEMEX non magnetic SQP diodes are particularly suitable for Magnetic Resonance Imaging applications. The maximum operating breakdown voltage is 550 V. Several values of total capacitance are available (beginning at 0.40 pF), together with a low forward series resistance.

These devices are characterized for high power handling, low loss and low distortion (long carrier lifetime design). The electrical properties are ideal for use in RF coils which must produce a homogeneous electromagnetic field in the MRI system for frequencies from a few MHz to over 100 MHz.

**Maximum ratings**

OPERATING JUNCTION	STORAGE	SOLDERING
- 55° C	- 65° C	230° C 5 sec.
+ 150° C	+ 150° C	

**Electrical characteristics**

STANDARD RATINGS - MAXIMUM LIMITS OF ELECTRICAL PARAMETERS								
PACKAGED DIODES								
Characteristics at 25° C	Applicable voltage V	Breakdown voltage V <sub>BR</sub>	Total capacitance C <sub>T</sub>		Forward series resistance R <sub>SF</sub>		Minority carrier lifetime τ <sub>I</sub>	Power dissipation
Test conditions	I <sub>R</sub> < 10 μA	I <sub>r</sub> < 10 μA	f = 1 MHz V <sub>R</sub> = 50 V		f = 120 MHz I <sub>F</sub> as below		I <sub>F</sub> = 10 mA I <sub>R</sub> = 6 mA	Contact surface (1)
TYPE	V	V	pF		Ω max		μs	W
	max	typ.	typ.	max	I <sub>F</sub> =100mA	I <sub>F</sub> =200mA	min.	max
DH80050-40	500	550	0.40	0.45	0.70	0.65	1.1	3.0
DH80051-40	500	550	0.55	0.65	0.60	0.55	1.5	3.5
DH80052-40	500	550	0.85	1.05	0.40	0.35	2.0	4.0
DH80053-40	500	550	1.05	1.20	0.35	0.30	2.5	4.0
DH80054-40	500	550	1.25	1.35	0.30	0.27	3.0	4.5
DH80055-40	500	550	1.45	1.55	0.25	0.22	3.5	4.5

(1) diode brazed on infinite copper heat sink





## HIGH VOLTAGE PIN DIODES

### *Applications*

These devices are most often used to control Radio Frequency (RF) and microwave signals. Typically, high-voltage PIN diodes are found in high power switches and phase shifters.

TEMEX high-voltage PIN diode products are designed for very high reliability, high power handling capabilities, high isolation, and low signal distortion, especially in the HF and VHF bands. High-power multithrow switch modules are available for frequencies in the 1 MHz to 1 GHz range.

All high-voltage PIN diode products can be configured on chips or in various packages: e.g. series, shunt, flat mount, stud mount, surface mount (SMD) and (on request) non-magnetic.

### *Characteristics*

The controlling element of a PIN diode is its Intrinsic (I) layer. The diode itself is a sandwich, i.e. a high resistivity I layer between highly doped layers of P and N materials. With negative bias on the I layer, the PIN diode exhibits very high parallel resistance, e.g. acting as a switch in the OFF position. A positive bias causes the diode to conduct, with very low series resistance. Certain applications impose specific objectives on diode construction (e.g. in the HF and VHF band, low signal distortion can be achieved with high Minority Carrier Lifetime  $\tau_I$ ).

## High voltage PIN diodes

**SILICON PIN DIODES FOR SWITCHING & PHASE SHIFTING APPLICATIONS (MEDIUM & HIGH POWER)***Description*

This series of high power, high voltage PIN diodes incorporates ceramic-glass passivated mesa technology. A broad range of products is available, in terms of breakdown voltages, junction capacitances and series resistances, to suit a large variety of applications, from 1 MHz to several GHz. These diodes are available in non-magnetic packages.

*Electrical characteristics*

CHIP DIODES					CHIP AND PACKAGED DIODES				
Characteristics at 25°C	Chip dimensions		Applicable voltage $V_R$	Break-down $V_{BR}$	Junction capacitance $C_j^{(1)}$		Forward series resistance $R_{SF}$		Minority carrier lifetime $\tau_I$
Test conditions	N/A		$I < 10\mu A$	$I < 10\mu A$	$V_R = 50 V$ $f = 1 MHz$		$f = 120 MHz$ $I_F$ AS SHOWN		$I_F = 10 mA$ $I_R = 6 mA$
TYPE	mm typ.		V	V	pF		$\Omega$ MAX		$\mu s$
PIN	Gold dia	per side	min.	typ.	typ.	max	$I_F = 100 mA$	$I_F = 200 mA$	min.
EH80050	0.13	0.6	500	550	0.15	0.20	0.70	0.65	1.1
EH80051	0.15	0.6	500	550	0.30	0.40	0.60	0.55	1.5
EH80052	0.25	0.8	500	550	0.60	0.70	0.40	0.30	2.0
EH80053	0.27	0.8	500	550	0.80	0.90	0.30	0.25	2.5
EH80055	0.34	0.9	500	550	1.2	1.3	0.25	0.22	3.0
EH80080	0.13	0.8	800	850	0.15	0.35	0.80	0.70	2.0
EH80083	0.27	0.9	800	850	0.80	0.90	0.40	0.30	3.0
EH80086	0.55	1.4	800	850	1.4	1.7	0.35	0.28	5.0
EH80100	0.23	0.9	1000	1100	0.30	0.40	0.70	0.60	3.0
EH80102	0.30	0.9	1000	1100	0.60	0.75	0.40	0.35	4.0
EH80106	0.55	1.4	1000	1100	1.40	1.70	0.35	0.30	7.0
					$V_R = 100V$		$I_F = 200 mA$	$I_F = 300 mA$	
EH80120	0.25	0.9	1200	1300	0.30	0.40	0.60	0.55	6.0
EH80124	0.65	1.5 H (2)	1200	1300	1.00	1.20	0.45	0.35	10.0
EH80126	0.75	1.7 H (2)	1200	1300	1.40	1.70	0.40	0.30	12.0
EH80129	1.25	2.2	1200	1300	2.00	2.30	0.30	0.25	15.0
EH80154	0.65	1.5	1500	1600	1.00	1.20	0.45	0.35	10.0
EH80159	1.25	2.2	1500	1600	2.00	2.30	0.30	0.25	15.0
					$V_R = 200V$		$I_F = 200 mA$	$I_F = 300 mA$	
EH80182	0.75	1.5	1800	1900	0.60	0.80	0.60	0.50	12.0
EH80189	1.4	2.6 H (2)	1800	1900	2.00	2.40	0.35	0.30	18.0
EH80204	0.85	1.7	2000	2100	1.00	1.30	0.50	0.40	14.0
EH80209	1.4	2.6 H (2)	2000	2100	2.00	2.40	0.35	0.30	18.0
EH80210	1.5	3 H (2)	2000	2100	3.00	3.40	0.20	0.15	25.0

(1) Other capacitance values available on request

(2) Hexagonal chips (between opposite flats)



PACKAGED DIODES						
Type	Standard case (3)			Thermal resistance $R_{TH}$ (4) $P_{DISS} = 1 W$	Typical operating conditions	
					VSWR < 1.5 $Z_0 = 50 \Omega$ Chip configuration	
				$^{\circ}C/W$	Frequency	Power
PIN	Shunt	Isolated stud	Flat mounted	max	MHz	W
DH80050	F 27d	BH301	BH202	20.0	50 - 20000	50
DH80051	F 27d	BH301	BH202	18.0	30 - 15000	80
DH80052	F 27d	BH301	BH202	15.0	20 - 10000	100
DH80053	F 27d	BH301	BH202	12.0	20 - 3000	100
DH80055	F 27d	BH301	BH202	10.0	10 - 1000	250
DH80080	F 27d	BH301	BH202	18.0	50 - 20000	60
DH80083	F 27d	BH301	BH202	12.0	20 - 10000	80
DH80086	BH35	BH301	BH202	8.0	10 - 500	200
DH80100	F 27d	BH301	BH202	15.0	20 - 10000	80
DH80102	F 27d	BH301	BH202	12.0	20 - 3000	100
DH80106	BH35	BH300	BH202	5.5	10 - 500	500
DH80120	F 27d	BH301	BH202	15.0	10 - 8000	100
DH80124	BH35	BH300	BH200	8.0	10 - 2000	250
DH80126	BH35	BH300	BH200	6.0	10 - 500	500
DH80129	BH141	BH300	BH200	4.5	5 - 200	1000
DH80154	BH141	BH300	BH200	8.0	10 - 2000	250
DH80159	BH141	BH300	BH200	4.5	5 - 200	1000
DH80182	BH35	BH300	BH200	10	10 - 50	
DH80189	BH141	BH300	BH200	4.5	15 - 200	1000
DH80204	BH141	BH300	BH200	8.0	10 - 1000	250
DH80209	BH141	BH300	BH200	4.5	1.5 - 200	1000
DH80210	BH141	BH300	BH200	2.5	1.5 - 50	1000

(3) Custom cases available on request (4)  $R_{TH}$  is measured in a standard shunt case, grounded on an infinite heatsink

**Temperature ranges:** Operating junction ( $T_j$ ): -55° C to +175° C Storage: -65° C to +200° C

## High voltage PIN diodes

**TWO & THREE PORT RF PIN SWITCH MODULES***Description*

This series of SP2T and SP3T RF switches uses high voltage PIN diodes, from the EH80000 family, to achieve very low loss and distortion.

These switches can be used from 1.5 to 1000 MHz, and can handle power levels up to 1000 W.

*Electrical characteristics*

Characteristics at 25°C			Frequency range	Loss L	Isolation I	Input power P <sub>in</sub>	Suggested bias conditions	
Test conditions			N/A	f (MHz) I <sub>f</sub> (mA)	f (MHz) V <sub>r</sub> (V)	cw	Forward	Reverse
Type	Case	Switch Type	MHz	dB	dB	W	mA	V
(1)		(2)	typ.	max	min.	max	typ.	typ.
				200 MHz 100 mA	100 MHz 0 V			
SH90101	TO39	SP2T	10 - 600	0.35	35	10	100	50
SH91101	TO39	SP2T	10 - 600	0.35	35	10	100	50
				400 MHz 100 mA	200 MHz 0 V			
SH90103	BH203	SP2T	20 - 1000	0.35	25	100	200	150
SH91103	BH203	SP2T	20 - 1000	0.35	25	100	200	150
SH92103	BH204	SP3T	20 - 1000	0.35	25	100	200	150
SH93103	BH204	SP3T	20 - 1000	0.35	25	100	200	150
				100 MHz 200 mA	200 MHz 100 V			
SH91107	BH403a	SP2T	20 - 500	0.20	33	1000	400	600
				10 MHz 200 mA	10 MHz 200 V			
SH90207	BH405	SP2T	1.5 - 50	0.15	37	1000	1000	700
SH91207	BH405	SP2T	1.5 - 50	0.15	37	1000	1000	700

(1) Series 90 and 92 : common anode  
Series 91 and 93 : common cathode

(2) Custom configurations available on request

*Temperature ranges:*

Operating junction (T<sub>j</sub>) : - 55° C to + 150° C

Storage : - 65° C to + 175° C

*Internal wiring diagrams*

*Typical performances*

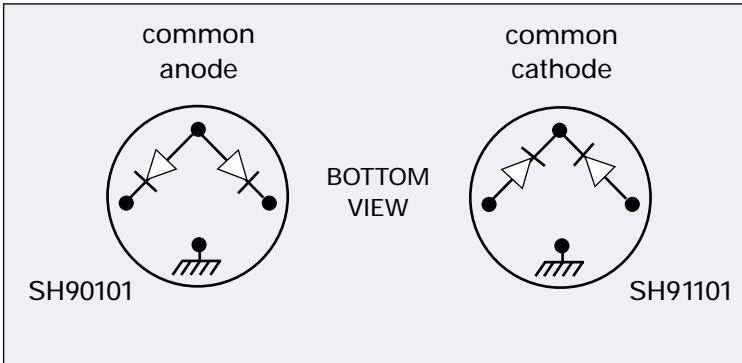

**INSERTION LOSS AND ISOLATION VERSUS FREQUENCY**

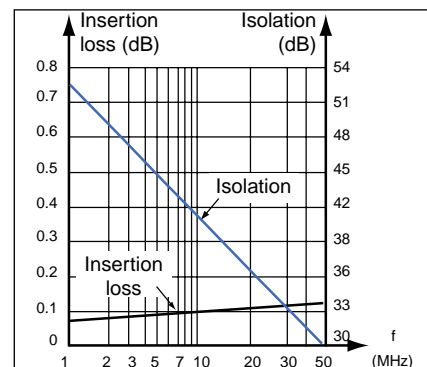
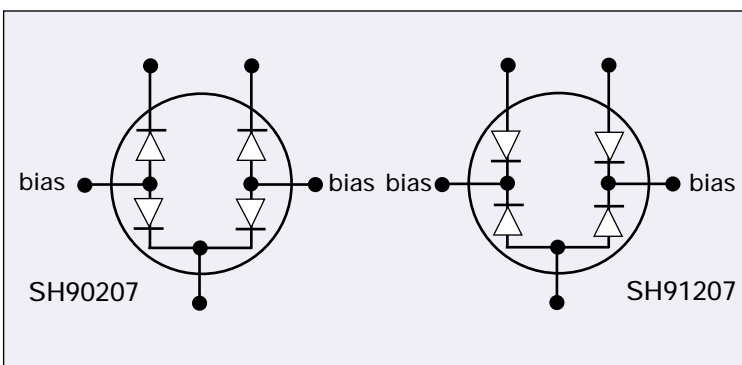
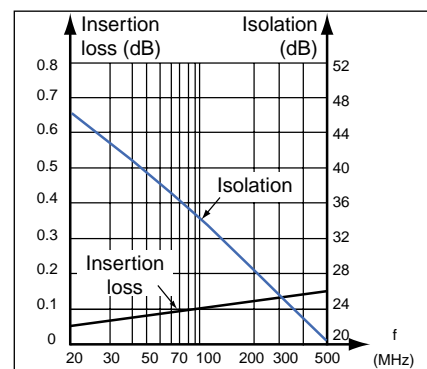
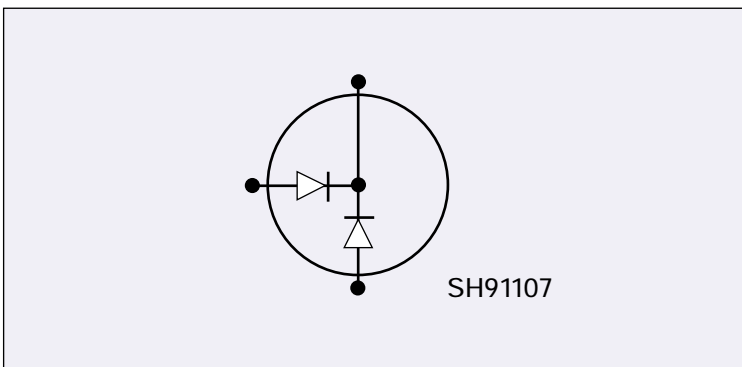
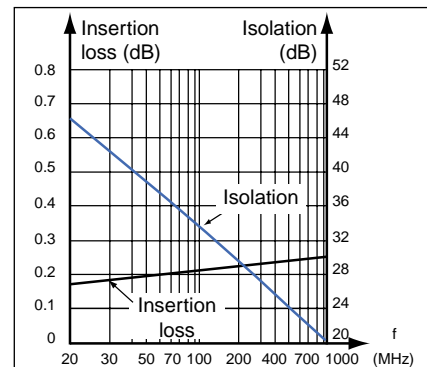
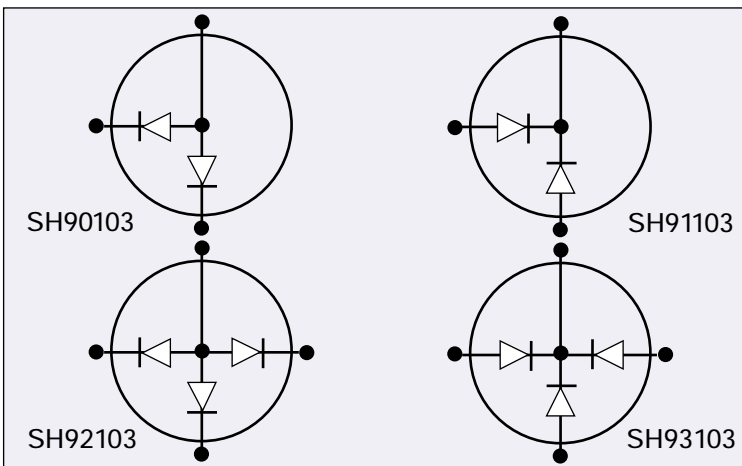
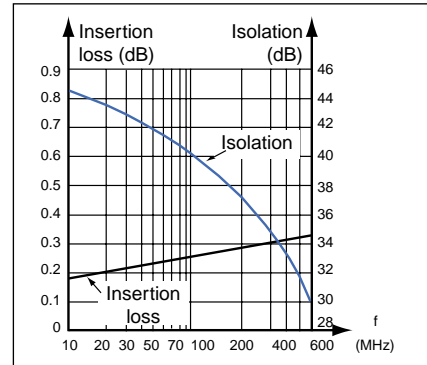

Microwave applications



## MICROWAVE APPLICATIONS

### *Low and medium voltage PIN diode applications*

The most common uses of these devices are: fast switching, attenuation and limiting. They operate at frequencies from a few MHz to 100 GHz.

In switching applications, e.g. timing digital bit streams, these PIN diodes support signal power levels below 30 W, up to 100 GHz. Thin I layers, from 1 to 50  $\mu\text{m}$ , and passivated mesa technology in chip configurations, yield very low junction capacitance ( $C_j$ ), i.e. below 0.025 pF.

As attenuators, e.g. in Automatic Gain Control (AGC) circuits, these PIN diodes are manufactured with a proprietary technology. This technology optimizes the relationship between  $C_j$  and  $R_{SF}$  (Forward Series Resistance), offering a high Minority Carrier Lifetime  $\tau_I$ , which minimizes signal distortion.

In limiting applications, e.g. passive protection for receivers, these PIN diodes operate as power dependent variable resistors.

## ULTRAFAST SWITCHING SILICON PIN DIODES

## Description

For ultrafast switching, these passivated mesa diodes have a thin I layer (< 10 μm).

## Electrical characteristics

CHIP DIODES		CHIP AND PACKAGED DIODES						PACKAGED DIODES			
Characteristics at 25°C	Gold dia	Breakdown voltage	Junction capacitance		Series resistance	Minority carrier lifetime	Reverse switching time			Thermal resistance	
	∅	V <sub>BR</sub>	C <sub>j</sub>		R <sub>SF</sub>	τ <sub>I</sub>	T <sub>CR</sub>			R <sub>th</sub>	
Test conditions		I <sub>R</sub> = 10 μA	V <sub>R</sub> = 6 V f = 1 MHz		I <sub>F</sub> = 10 mA f = 120 MHz	I <sub>F</sub> = 10 mA I <sub>R</sub> = 6 mA	I <sub>F</sub> = 20 mA V <sub>R</sub> = 10 V 50 Ω			P <sub>diss</sub> 1 W F 27 d	
Type	μm	V	pF		Ω	ns	ns	Type	Standard cases (1)		°C/W
Case C2a (1)	typ.	min.	typ.	max	max	typ.	typ.		C <sub>b</sub> = 0.18 pF (2)	C <sub>b</sub> = 0.12 pF (2)	max
EH50033	25	30	0.08	0.12	1.8	20	2.0	DH50033	F27d	M208	80
EH50034	30	30	0.12	0.17	1.5	20	2.0	DH50034	F27d	M208	80
EH50035	35	30	0.17	0.23	1.0	25	2.5	DH50035	F27d	M208	70
EH50036	55	30	0.23	0.40	0.9	30	3.0	DH50036	F27d	M208	60
EH50037	65	30	0.40	0.60	0.7	40	4.0	DH50037	F27d	M208	50
EH50052	30	50	0.06	0.08	1.6	30	3.0	DH50052	F27d	M208	80
EH50053	35	50	0.08	0.12	1.4	30	3.0	DH50053	F27d	M208	70
EH50054	40	50	0.12	0.17	1.1	35	4.0	DH50054	F27d	M208	60
EH50055	50	50	0.17	0.23	1.0	40	4.0	DH50055	F27d	M208	50
EH50056	65	50	0.23	0.40	0.9	50	5.0	DH50056	F27d	M208	45
EH50057	80	50	0.40	0.60	0.7	60	6.0	DH50057	F27d	M208	45
EH50071	35	70	0.04	0.06	2.0	50	5.0	DH50071	F27d	M208	70
EH50072	40	70	0.06	0.08	1.7	50	5.0	DH50072	F27d	M208	70
EH50073	45	70	0.08	0.12	1.6	60	6.0	DH50073	F27d	M208	60
EH50074	50	70	0.12	0.17	1.4	60	6.0	DH50074	F27d	M208	50
EH50075	60	70	0.17	0.23	1.0	100	10.0	DH50075	F27d	M208	45
EH50076	80	70	0.23	0.40	0.9	100	10.0	DH50076	F27d	M208	40
EH50077	100	70	0.40	0.60	0.7	150	15.0	DH50077	F27d	M208	40
EH50101	45	100	0.04	0.06	1.9	150	15.0	DH50101	F27d	M208	60
EH50102	50	100	0.06	0.08	1.7	150	15.0	DH50102	F27d	M208	60
EH50103	60	100	0.08	0.12	1.4	200	20.0	DH50103	F27d	M208	55
EH50104	70	100	0.12	0.17	1.2	250	25.0	DH50104	F27d	M208	50
EH50105	90	100	0.17	0.23	1.0	300	30.0	DH50105	F27d	M208	40
EH50106	110	100	0.23	0.40	0.8	400	40.0	DH50106	F27d	M208	35
EH50107	130	100	0.40	0.60	0.6	500	50.0	DH50107	F27d	M208	35

(1) Custom cases available on request

(2)  $C_T = C_j + C_b$

**Temperature ranges:**

Operating Junction (T<sub>j</sub>) : -55° C to +175° C

Storage : -65° C to +200° C

Microwave applications

**FAST SWITCHING SILICON PIN DIODES***Description*

For fast switching, these passivated mesa diodes have a medium I layer (&lt; 50 µm).

*Electrical characteristics*

CHIP DIODES		CHIP AND PACKAGED DIODES						PACKAGED DIODES			
Characteristics at 25°C	Gold dia	Breakdown voltage	Junction capacitance		Series resistance	Minority carrier lifetime	Reverse switching time			Thermal resistance	
	Ø	V <sub>BR</sub>	C <sub>j</sub>		R <sub>SF</sub>	τ <sub>I</sub>	T <sub>CR</sub>			R <sub>th</sub>	
Test conditions		I <sub>R</sub> = 10 µA	V <sub>R</sub> = 50 V f = 1 MHz		I <sub>F</sub> = 10 mA f = 120 MHz	I <sub>F</sub> = 10 mA I <sub>R</sub> = 6 mA	I <sub>F</sub> = 20 mA V <sub>R</sub> = 10 V 50 Ω			P <sub>diss</sub> 1 W F27 d	
Type	µm	V	pF		Ω	ns	ns	Type	Standard cases (2)		°C/W
Case C2a (1)	typ.	min.	typ.	max	max	typ.	typ.		C <sub>b</sub> = 0.18 pF (2)	C <sub>b</sub> = 0.12 pF (2)	max
EH50151	55	150	0.04	0.06	2.0	200	20	DH50151	F27d	M208	50
EH50152	60	150	0.06	0.08	1.7	230	23	DH50152	F27d	M208	50
EH50153	70	150	0.08	0.12	1.5	300	30	DH50153	F27d	M208	45
EH50154	90	150	0.12	0.17	1.4	500	50	DH50154	F27d	M208	40
EH50155	110	150	0.17	0.23	1.0	550	55	DH50155	F27d	M208	35
EH50156	130	150	0.23	0.40	0.8	800	80	DH50156	F27d	M208	30
EH50157	150	150	0.40	0.60	0.6	950	95	DH50157	F27d	M208	30
EH50201	60	200	0.04	0.06	2.3	300	30	DH50201	F27d	M208	45
EH50202	65	200	0.06	0.08	2.1	400	40	DH50202	F27d	M208	45
EH50203	75	200	0.08	0.12	1.5	500	50	DH50203	F27d	M208	40
EH50204	100	200	0.12	0.17	1.3	650	65	DH50204	F27d	M208	35
EH50205	120	200	0.17	0.23	1.0	800	80	DH50205	F27d	M208	30
EH50206	150	200	0.23	0.40	0.8	950	95	DH50206	F27d	M208	30
EH50207	170	200	0.40	0.60	0.7	1050	100	DH50207	F27d	M208	25
EH50251	65	250	0.04	0.06	2.4	330	33	DH50251	F27d	M208	40
EH50252	75	250	0.06	0.08	2.2	500	50	DH50252	F27d	M208	40
EH50253	100	250	0.08	0.12	2.0	900	90	DH50253	F27d	M208	35
EH50254	130	250	0.12	0.17	1.4	900	90	DH50254	F27d	M208	30
EH50255	160	250	0.17	0.23	0.9	1000	100	DH50255	F27d	M208	30
EH50256	180	250	0.23	0.40	0.8	1150	110	DH50256	F27d	BH142	25
EH50401	80	400	0.04	0.06	2.5	700	70	DH50401	F27d	M208	35
EH50402	90	400	0.06	0.08	2.3	800	80	DH50402	F27d	M208	35
EH50403	120	400	0.08	0.12	2.1	1000	100	DH50403	F27d	M208	30
EH50404	150	400	0.12	0.17	1.8	1500	150	DH50404	F27d	BH142	25
EH50405	200	400	0.17	0.23	1.6	2000	200	DH50405	F27d	BH142	20

(1) Chip presentation C2a, except:  
C2b for EH50256, EH50404 and EH50405

(2) Custom cases available on request

(3) C<sub>T</sub> = C<sub>j</sub> + C<sub>b</sub>

**Temperature ranges:**

Operating junction (T<sub>j</sub>) : -55° C to +175° C

Storage : -65° C to +200° C



## ATTENUATOR SILICON PIN DIODES

### Description

The table below presents a single set of values from the variety of customer options available for this series of passivated PIN diodes. TEMEX uses its proprietary technology, which enables the customer to incorporate characteristics specific to the application involved, e.g. capacitance and I zone thickness. Typical applications include variable RF attenuators and AGC (Automatic Gain Control) circuits, from a few MHz to several GHz.

### Electrical characteristics

CHIP DIODES		CHIP AND PACKAGED DIODES											PACKAGED DIODES		
Charact. at 25°C	C O N F I G U R A T I O N	I ZONE THICKNESS (1)	Series resistance $R_{SF}$						Junction capacitance $C_J$ (2)		Reverse current $I_R$	Minority carrier lifetime $\tau_I$			
Test conditions		$\mu\text{m}$	F = 120 MHz						F = 1 MHz $V_R = 50\text{ V}$		$V_R = 100\text{ V}$	$I_F = 10\text{ mA}$ $I_R = 6\text{ mA}$			
Type			$I_F = 0.1\text{ mA}$	$I_F = 1\text{ mA}$		$I_F = 10\text{ mA}$		pF		$\mu\text{A}$	$\mu\text{s}$		Type	Standard package (3)	
		typ.	min.	max.	min.	max.	min.	max.	typ.	max.	max.	min.	typ.		
EH40073	C4c	70	70	140	8	16	1.0	2.0	0.30	0.50	10	1.5	2.0	DH40073	F 27d
EH40141	C4a	140	400	800	50	100	6.5	13.0	0.05	0.10	10	1.5	2.5	DH40141	F 27d
EH40144	C4c	140	200	400	25	50	3.5	7.0	0.10	0.30	10	4.0	5.0	DH40144	F 27d
EH40225	C4d	220	400	800	50	100	6.5	13.0	0.10	0.30	10	5.5	7.0	DH40225	F 27d

- (1) Other I zone thicknesses available on request
- (2) Other capacitance values available on request
- (3) Custom cases available on request

#### Temperature ranges:

Operating junction ( $T_j$ ) : -55° C to +175° C  
Storage : -65° C to +200° C

### Typical series resistance vs forward current

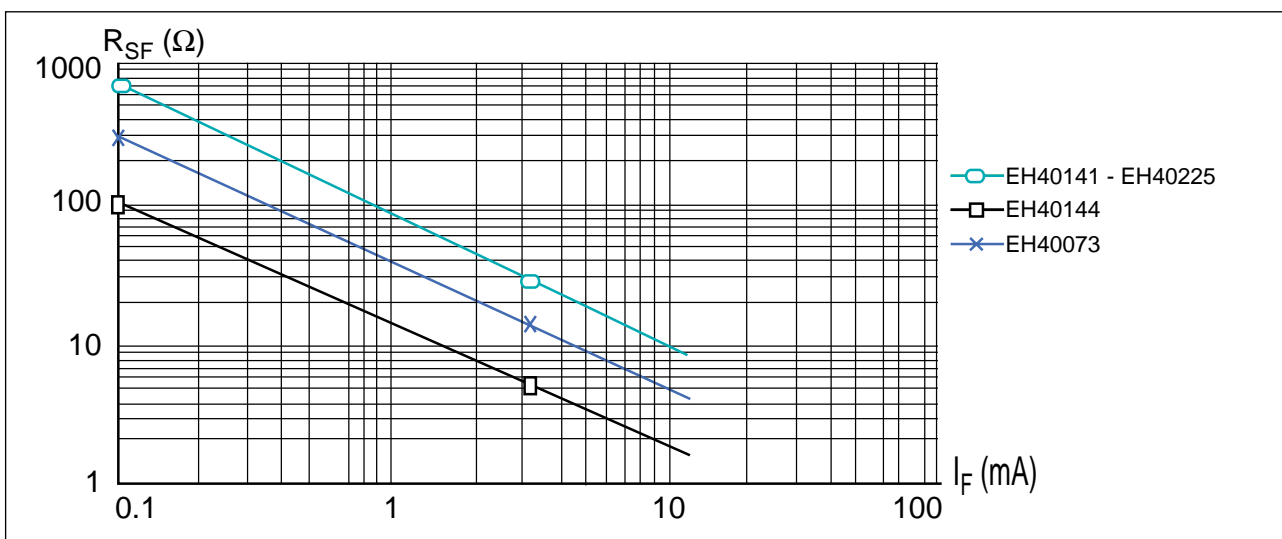

Microwave applications



## SILICON LIMITER PIN DIODES

### Description

These passivated mesa PIN diodes have a thin I layer. This series of diodes is available as chips and in hermetic ceramic packages. They operate as power dependent variable resistances and provide passive receiver protection (low noise amplifiers, mixers, and detectors).

### Electrical characteristics

CHIP DIODES			PACKAGED DIODES						
Characteristics at 25°C		GOLD DIA Ø	Breakdown voltage $V_{BR}$		Junction capacitance $C_{j0}$	Junction capacitance $C_{j-6}$ (1)		Series resistance $R_{SF}$	Minority carrier lifetime $\tau_i$
Test conditions			$I_R = 10 \mu A$		$V_R = 0 V$ $f = 1 \text{ MHz}$	$V_R = 6 V$ $f = 1 \text{ MHz}$		$I_F = 10 \text{ mA}$ $f = 120 \text{ MHz}$	$I_F = 10 \text{ mA}$ $I_R = 6 \text{ mA}$
Type	Case	$\mu m$	V		pF	pF		$\Omega$	ns
		typ.	min.	max	typ.	min.	max	max	typ.
EH60033	C2a	25	25	50	0.14	0.08	0.12	1.8	20
EH60034	C2a	30	25	50	0.20	0.12	0.17	1.5	20
EH60035	C2a	35	25	50	0.28	0.17	0.23	1.0	25
EH60036	C2a	55	25	50	0.45	0.23	0.40	0.9	30
EH60037	C2a	65	25	50	0.70	0.40	0.60	0.7	40
EH60052	C2a	30	50	70	0.10	0.06	0.08	1.8	30
EH60053	C2a	35	50	70	0.14	0.08	0.12	1.4	30
EH60054	C2a	40	50	70	0.20	0.12	0.17	1.1	35
EH60055	C2a	50	50	70	0.28	0.17	0.23	1.0	40
EH60056	C2a	65	50	70	0.45	0.23	0.40	0.9	50
EH60057	C2a	80	50	70	0.70	0.40	0.60	0.8	60
EH60072	C2a	40	70	90	0.10	0.06	0.08	1.7	50
EH60074	C2a	50	70	90	0.20	0.12	0.17	1.4	60
EH60076	C2a	80	70	90	0.45	0.23	0.40	0.9	100
EH60102	C2a	50	90	120	0.10	0.06	0.08	1.7	150
EH60104	C2a	70	90	120	0.20	0.12	0.17	1.2	250
EH60106	C2a	110	90	120	0.45	0.23	0.40	0.8	400

(1) Other values of capacitance available on request

PACKAGED DIODES			NOMINAL MICROWAVE CHARACTERISTICS					
Characteristics at 25°C			Thermal resistance $R_{TH}$	Threshold $P_L$	Leakage power $P_{OUT}$	Insertion loss $L$	Peak power $P_{IN}$	CW power $P_{IN}$
Test conditions			$P_{diss} = 1W$ case F 27d	$f = 2.7 GHz$ 1dB Limiting	$f = 2.7 GHz$	$f = 2.7 GHz$ $P_{IN} = -10$ dBm	1 $\mu s$ Pulse 1% DC	
Type	Standard case (2)		°C/W	dBm	dBm	dB	dBm	W
	$C_b = 0.18 pF$ (3)	$C_b = 0.12 pF$ (3)	max	typ.	typ.	typ.	max	max
DH60033	F 27d	M208	80	+ 10	+ 20	0.1	+ 50	2.0
DH60034	F 27d	M208	80	+ 10	+ 20	0.1	+ 50	2.0
DH60035	F 27d	M208	70	+ 10	+ 21	0.1	+ 52	2.5
DH60036	F 27d	M208	60	+ 10	+ 22	0.2	+ 53	3.0
DH60037	F 27d	M208	50	+ 10	+ 23	0.2	+ 56	4.0
DH60052	F 27d	M208	80	+ 15	+ 24	0.1	+ 52	2.5
DH60053	F 27d	M208	70	+ 15	+ 24	0.1	+ 52	2.5
DH60054	F 27d	M208	60	+ 15	+ 25	0.1	+ 53	3.0
DH60055	F 27d	M208	50	+ 15	+ 26	0.1	+ 54	3.5
DH60056	F 27d	M208	45	+ 15	+ 27	0.2	+ 57	4.0
DH60057	F 27d	M208	45	+ 15	+ 28	0.2	+ 58	5.0
DH60072	F 27d	M208	70	+ 18	+ 27	0.1	+ 54	3.0
DH60074	F 27d	M208	50	+ 18	+ 30	0.2	+ 55	4.0
DH60076	F 27d	M208	40	+ 18	+ 32	0.2	+ 58	5.0
DH60102	F 27d	M208	60	+ 20	+ 31	0.2	+ 56	3.5
DH60104	F 27d	M208	50	+ 20	+ 33	0.2	+ 59	5.0
DH60106	F 27d	M208	35	+ 20	+ 35	0.3	+ 61	7.0

(2) Other capacitance values available on request

(3)  $C_T = C_j + C_b$ **Temperature ranges:**Operating junction ( $T_j$ ) : -55° C to +125° C

Storage : -65° C to +200° C

Selection guide



# ▶ SILICON SCHOTTKY DIODES

## Selection Guide

	PAGE
<u>SCHOTTKY BARRIER DETECTOR DIODES</u>	<u>12-29</u>
<u>SCHOTTKY BARRIER MIXER DIODES</u>	<u>12-30</u>



SILICON SCHOTTKY BARRIER DETECTOR DIODES

Description

Silicon Schottky barrier detector diodes are available as:

- packaged diodes
- chip

They are optimized for wide band applications, in the frequency range from 1 to 18 GHz.

Electrical characteristics packaged diodes

Characteristics at 25°C		Frequency range $F_{oper}$	Tangential sensitivity $T_{SS}$	Video resistance $R_V$		RF power $P_{RF}$	Forward continuous current $I_F$	Breakdown voltage $V_{BR}$
Test conditions		N/A	Video bandwidth = 1 MHz $I_F = 30 \mu A$			CW	N/A	$I_R = 10 \mu A$
TYPE	CASE (1)	GHz	dBm	kΩ		mW	mA	V
			min.	min.	max	max	max	typ.
DH340	F51	2 - 12	- 54	1	2	250	50	3
		12 - 18	- 51					

(1) Custom cases available on request

Temperature ranges:

Operating junction ( $T_j$ ) : -55° C to +150° C

Storage : -65° C to +175° C

- $T = + 25^\circ C$
- $I_F = 30 \mu A$
- Video bandwidth = 1 MHz

Typical tangential sensitivity vs frequency

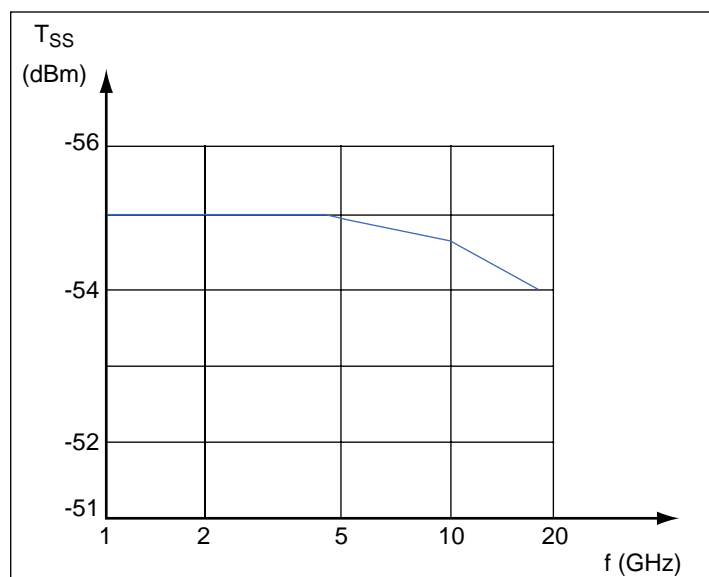

## Silicon Schottky barrier mixer diodes

**SILICON SCHOTTKY BARRIER MIXER DIODES***Description*

Silicon Schottky barrier mixer diodes are available in the following configurations:

- packaged
- chip

Low barrier diodes are required for applications where the Local Oscillator (LO) drive level is between -10 dBm and +10 dBm. Medium barrier diodes are required for applications where the LO drive level is between -5 dBm and +15 dBm. The use of a passivated planar construction contributes to high reliability.

*Electrical characteristics packaged diodes*

Characteristics at 25°C		Frequency range $F_{oper}$	SSB Noise figure $NF_{SSB}$	VSWR (ratio)		IF Impedance $Z_{IF}$		Test pulse energy	Breakdown voltage $V_{BR}$	Total capacitance $C_{TO}$
Test conditions		N/A	(1)	N/A		f = 30 MHz $P_{LO} = 1$ mW		Pulse = 3 ns	$I_R = 10$ $\mu$ A	F = 1 MHz $V_R = 0$ V
Type	Case (2)	GHz	dB	ratio		$\Omega$		Ergs	V	pF
			max	typ.	max	min.	max	max	typ.	typ.
DH301	F51	1 - 6	6.5	1.5	2	200	400	5	3	0.40
DH302	F51	1 - 6	6.0	1.5	2	200	400	5	3	0.40
DH303	F51	1 - 6	5.5	1.5	2	200	400	5	3	0.40
DH312	F51	6 - 12	7.0	1.5	2	200	400	5	3	0.25
DH313	F51	6 - 12	6.5	1.5	2	200	400	5	3	0.25
DH314	F51	6 - 12	6.0	1.5	2	200	400	5	3	0.25
DH315	F51	6 - 12	5.5	1.5	2	200	400	5	3	0.25
DH322	F51	12 - 18	7.5	1.5	2	200	400	5	3	0.17
DH323	F51	12 - 18	7.0	1.5	2	200	400	5	3	0.17
DH324	F51	12 - 18	6.5	1.5	2	200	400	5	3	0.17
DH325	F51	12 - 18	6.0	1.5	2	200	400	5	3	0.17

RF Power max: 250 mW CW

**Temperature ranges:**

Operating junction ( $T_j$ ) : -55° C to +150° C

Storage : -65° C to +175° C

(1) Noise figure measurement conditions:

$P_{LO} = 1$  mW

$f_{IF} = 30$  MHz

$NF_{IF} = 1.5$  dB

noise tube: 15.6 dB

dc load = 10  $\Omega$

test frequencies: 3.0, 9.3 or 15.0 GHz

(2) Custom cases available on request



## ▶ TUNING VARACTOR

### Selection Guide

	PAGE
<u><a href="#">SURFACE MOUNT SILICON ABRUPT TUNING VARACTOR</a></u>	<u><a href="#">12-32</a></u>
<u><a href="#">HIGH Q SILICON ABRUPT JUNCTION TUNING VARACTOR</a></u>	
- <u><a href="#">VBR = 30 V</a></u>	<u><a href="#">12-34</a></u>
- <u><a href="#">VBR = 45 V</a></u>	<u><a href="#">12-35</a></u>
<u><a href="#">SILICON HYPERABRUPT JUNCTION TUNING VARACTOR</a></u>	<u><a href="#">12-36</a></u>
<u><a href="#">MICROWAVE SILICON HYPERABRUPT JUNCTION TUNING VARACTOR</a></u>	<u><a href="#">12-39</a></u>

*A tuning varactor is a P-N diode that acts as a voltage controlled capacitor. These devices perform the same function as the familiar, bulky, air dielectric stacked capacitors featured in traditional broadcast band receivers.*

Plastic package Surface Mount Silicon abrupt tuning varactor



## SOT23 SURFACE MOUNT SILICON ABRUPT TUNING VARACTOR

### *Description*

This series of silicon tuning varactors have an epitaxial mesa design with a high temperature passivation. This technology is used to produce abrupt tuning varactor in SOT23 package. This family is designed for a low cost medium to high volume market that may be supplied in tape and reel for automated pick and place assembly on surface mount circuit boards.

### *Applications*

The DH71000 series abrupt tuning varactor are offered in a large selection of capacitance range. They provide the highest Q factor (low reverse series resistance) available for a 30 volts silicon device. Typical applications include low noise narrow and moderate frequency bandwidth applications (VCO mainly) from HF to Microwave frequencies (up to 3 GHz). Other applications are voltage tuned filters, phase shifters, delay line, etc.

**NOTE:** Variation of the junction capacitance versus reverse voltage follows this equation:

$$C_j (V_r) = \frac{C_j (0 V)}{\left[ 1 + \frac{V_r}{\phi} \right]^\gamma}$$

$V_r$  : Reverse voltage

$\phi$  : Built-in potential .7V for Si

$\gamma$  : .5 for abrupt tuning varactor



Plastic package Surface Mount Silicon abrupt tuning varactor

Electrical characteristics at Ta = +25° C

Reverse breakdown voltage, Vb = @10 µA: 30 V min.



Electrical parameters	Breakdown voltage V <sub>BR</sub>	Junction capacitance C <sub>j</sub>	Tuning ratio	Figure of merit Q
Test Conditions	I <sub>R</sub> = 10 µA	F = 1 MHz V <sub>R</sub> = 4 V	C <sub>j0V</sub> /C <sub>j30V</sub>	V <sub>R</sub> = 4 V F = 50 MHz
Type	V	pF	typ.	typ.
	min.	(1)		
DH71010	30	1.0 ± 20%	4.0	4300
DH71016	30	1.6 ± 20%	4.5	4100
DH71020	30	2.0 ± 20%	4.6	3900
DH71030	30	3.0 ± 20%	4.7	3400
DH71045	30	4.5 ± 20%	4.8	2200
DH71067	30	6.7 ± 10%	4.9	2600
DH71100	30	10 ± 10%	5.0	2200

(1) Other tolerance on request

Temperature ranges:

Operating junction (T<sub>j</sub>): -55° C to +125° C Storage: -65° C to +150° C

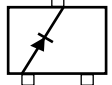
Packages

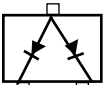
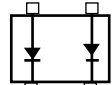
Packages	SOD323	SOT23	SOT23	SOT23	SOT143
					
DH71010	DH71010-60	DH71010-51	DH71010-53	DH71010-54	DH71010-70
DH71016	DH71016-60	DH71016-51	DH71016-53	DH71016-54	DH71016-70
DH71020	DH71020-60	DH71020-51	DH71020-53	DH71020-54	DH71020-70
DH71030	DH71030-60	DH71030-51	DH71030-53	DH71030-54	DH71030-70
DH71045	DH71045-60	DH71045-51	DH71045-53	DH71045-54	DH71045-70
DH71067	DH71067-60	DH71067-51	DH71067-53	DH71067-54	DH71067-70
DH71100	DH71100-60	DH71100-51	DH71100-53	DH71100-54	DH71100-70

(1) Other configuration available on request.

How to order?

DH71010	-	51	T3
Diode type		Package information	Conditioning
		51: single SOT23 53: dual common cathode SOT23 54: dual common anode SOT23 60: single SOD323 70: dual SOT143	T3: 3000 pieces tape & reel T10: 10000 pieces tape & reel blank: bulk

High Q silicon abrupt junction tuning varactor

**HIGH Q SILICON ABRUPT JUNCTION TUNING VARACTOR** $V_{BR} 30V$ **Description**

This series of high Q epi-junction microwave tuning varactors (30 V) incorporates a passivated mesa technology. It is well suited for frequency tuning applications up to Ku band.

CHIP DIODES			CHIP AND PACKAGED DIODES		PACKAGED DIODES (1)				
			$V_{BR} (10 \mu A) \geq 30 V$		Standard cases			Other cases	
Characteristics at 25°C		Gold dia $\emptyset$	junction capacitance $C_j$	Fig. of merit Q			Tuning ratio $C_{T0}/C_{T30}$		
Test Conditions			$V_R = 4 V$ $f = 1 MHz$	$V_R = 4 V$ $f = 50 MHz$	CASE CAPACITANCE $C_b$			CASE CAPACITANCE $C_b$	
Type	Case	$\mu m$	pF		Type	Case		Case	
		typ.	$\pm 20 \% (2)$	min.		$C_b = 0.18 pF (3)$	min.	$C_b = 0.12 pF (3)$ min.	
EH71004	C2a	50	0.4	4500	DH71004	F27d	3.0	M208	3.3
EH71006	C2a	60	0.6	4500	DH71006	F27d	3.4	M208	3.7
EH71008	C2a	70	0.8	4400	DH71008	F27d	3.7	M208	4.0
EH71010	C2a	80	1.0	4300	DH71010	F27d	4.0	M208	4.3
EH71012	C2a	90	1.2	4200	DH71012	F27d	4.3	M208	4.5
EH71016	C2a	100	1.6	4100	DH71016	F27d	4.5	M208	4.6
EH71020	C2a	110	2.0	3900	DH71020	F27d	4.6	M208	4.7
EH71025	C2a	120	2.5	3600	DH71025	F27d	4.6	M208	4.8
EH71030	C2a	140	3.0	3400	DH71030	F27d	4.7	M208	4.8
EH71037	C2a	150	3.7	3200	DH71037	F27d	4.7	M208	4.8
EH71045	C2a	170	4.5	3000	DH71045	F27d	4.8	M208	4.9
EH71054	C2a	180	5.4	2800	DH71054	F27d	4.8	M208	4.9
			$\pm 10 \% (2)$			$C_b = 0.18 pF (3)$		$C_b = 0.2 pF (3)$	
EH71067	C2a	200	6.7	2600	DH71067	F27d	4.9	BH142	4.9
EH71080	C2b	220	8.0	2400	DH71080	F27d	5.0	BH142	5.0
EH71100	C2b	250	10.0	2200	DH71100	F27d	5.0	BH142	5.0
EH71120	C2b	270	12.0	2000	DH71120	F27d	5.1	BH142	5.1
EH71150	C2b	300	15.0	1800	DH71150	F27d	5.1	BH142	5.1
EH71180	C2b	330	18.0	1700	DH71180	F27d	5.2	BH142	5.2
EH71200	C2b	350	20.0	1500	DH71200	F27d	5.2	BH142	5.2
EH71220	C2b	370	22.0	1400	DH71220	F27d	5.2	BH142	5.2
EH71270	C2b	410	27.0	1300	DH71270	F27d	5.2	BH142	5.2
EH71330	C2c	450	33.0	1200	DH71330	F27d	5.2	BH142	5.2
EH71390	C2c	500	39.0	950	DH71390	F27d	5.2	BH142	5.2
EH71470	C2c	540	47.0	750	DH71470	F27d	5.2	BH142	5.2
EH71560	C2c	590	56.0	650	DH71560	F27d	5.2	BH142	5.2
EH71680	C2c	650	68.0	500	DH71680	F27d	5.2	BH142	5.2
EH71820	C2d	720	82.0	400	DH71820	F27d	5.2	BH142	5.2
EH71999	C2d	800	100.0	300	DH71999	F27d	5.2	BH142	5.2

(1) Custom cases available on request

(2) Closer capacitance tolerances available on request

(3)  $C_T = C_j + C_b$ **Temperature ranges:**Operating junction ( $T_j$ ) : -55° C to +150° C

Storage : -65° C to +175° C

## High Q silicon abrupt junction tuning varactor

$V_{BR} 45 V$

**Description**

This series of high Q epi-junction microwave tuning varactors (45 V) incorporates a passivated mesa technology. It is well suited for frequency tuning applications up to X band.

Chip diodes			Chip and packaged diodes		Packaged diodes (1)				
			$V_{BR} (10 \mu A) \geq 45 V$		STANDARD CASES		OTHER CASES		
Characteristics at 25° C		GOLD DIA Ø	Junction capacitance $C_j$	Fig. of merit Q			Tuning Ratio $C_{T0}/C_{T45}$		
Test conditions			$V_R = 4 V$ $f = 1 MHz$	$V_R = 4 V$ $f = 50 MHz$				Case Capacitance $C_b$	
Type	Case	$\mu m$	pF		Type	Case		Case	
		typ.	$\pm 20 \% (2)$		min.	$C_b = 0.18 pF (3)$	min.	$C_b = 0.12 pF (3)$	min.
EH72004	C2a	60	0.4	3000	DH72004	F27d	3.5	M208	3.7
EH72006	C2a	80	0.6	2900	DH72006	F27d	3.9	M208	4.1
EH72008	C2a	90	0.8	2800	DH72008	F27d	4.2	M208	4.5
EH72010	C2a	110	1.0	2700	DH72010	F27d	4.5	M208	4.7
EH72012	C2a	110	1.2	2700	DH72012	F27d	4.7	M208	4.9
EH72016	C2a	120	1.6	2600	DH72016	F27d	5.0	M208	5.2
EH72020	C2a	140	2.0	2500	DH72020	F27d	5.2	M208	5.5
EH72025	C2a	150	2.5	2400	DH72025	F27d	5.4	M208	5.6
EH72030	C2a	170	3.0	2300	DH72030	F27d	5.5	M208	5.7
EH72037	C2a	190	3.7	2200	DH72037	F27d	5.6	M208	5.7
EH72045	C2a	210	4.5	2000	DH72045	F27d	5.7	M208	5.8
EH72054	C2a	230	5.4	1900	DH72054	F27d	5.8	M208	5.9
			$\pm 10 \% (2)$			$C_b = 0.18 pF (3)$		$C_b = 0.2 pF (3)$	
EH72067	C2b	250	6.7	1800	DH72067	F27d	5.9	BH142	6.0
EH72080	C2b	280	8.0	1700	DH72080	F27d	5.9	BH142	6.0
EH72100	C2b	310	10.0	1600	DH72100	F27d	6.0	BH142	6.0
EH72120	C2b	340	12.0	1500	DH72120	F27d	6.0	BH142	6.0
EH72150	C2b	380	15.0	1400	DH72150	F27d	6.0	BH142	6.0
EH72180	C2b	420	18.0	1300	DH72180	F27d	6.0	BH142	6.0
EH72200	C2b	440	20.0	1200	DH72200	F27d	6.0	BH142	6.0
EH72220	C2c	470	22.0	1100	DH72220	F27d	6.0	BH142	6.0
EH72270	C2c	520	27.0	1000	DH72270	F27d	6.0	BH142	6.0
EH72330	C2c	570	33.0	900	DH72330	F27d	6.0	BH142	6.0
EH72390	C2c	620	39.0	800	DH72390	F27d	6.0	BH142	6.0
			$\pm 10 \% (2)$			$C_b = 0.18 pF (3)$			
EH72470	C2d	680	47.0	700	DH72470	BH28	6.0		
EH72560	C2d	740	56.0	600	DH72560	BH28	6.0		
EH72680	C2d	820	68.0	450	DH72680	BH28	6.0		
			$\pm 10 \% (2)$			$C_b = 0.4 pF (3)$			
EH72820	C2g	900	82.0	350	DH72820	BH141	6.0		
EH72999	C2g	1000	100.0	250	DH72999	BH141	6.0		

(1) Custom cases available on request

(2) Closer capacitance tolerances available on request

(3)  $C_T = C_j + C_b$ **Temperature ranges:**Operating junction ( $T_j$ ) : -55° C to +150° C

Storage : -65° C to +175° C

Plastic package, Surface Mount hyperabrupt tuning varactor

## PLASTIC PACKAGE, SURFACE MOUNT HYPERABRUPT TUNING VARACTOR

### Description

This series of silicon tuning varactors consists of hyperabrupt epitaxial devices. They incorporate a passivated mesa technology. This family is designed for a low cost medium to high volume market that may be supplied in tape and reel for automated pick and place assembly on surface mount circuit boards.

### Application

The DH76000 and DH77000 series hyperabrupt tuning varactor are offered in a large selection of capacitance range. They provide the highest Q factor (low reverse series resistance). Typical applications include low noise narrow and moderate frequency bandwidth applications (VCO mainly) from HF to Microwave frequencies (up to 3 GHz). Other applications are voltage tuned filters, phase shifters, delay lines...

### 20 Volt hyperabrupt junction varactors

#### Characteristics @ $T_a = +25^\circ\text{C}$

Reverse breakdown voltage,  $V_b = 20\text{ V min. @ } 10\ \mu\text{A}$   
Reverse Current,  $I_r = 200\ \text{nA @ } 16\text{ V}$

#### Temperature ranges:

Operating junction ( $T_j$ ) :  $-55^\circ\text{C}$  to  $+125^\circ\text{C}$   
Storage :  $-55^\circ\text{C}$  to  $+150^\circ\text{C}$

Test conditions	Total capacitance (pF) Ct				Tuning ratio	
	f = 1 MHz Vr = 1 V	f = 1 MHz Vr = 4 V	f=1 MHz Vr = 12 V	f = 1 MHz Vr = 20 V	Ct1V/Ct12V f = 1 MHz	Ct1V/Ct20V f = 1 MHz
	typ	$\pm 20\%$	typ.	typ.	typ.	typ.
Type						
DH76010	2.5	1.2	0.6	0.5	4.1	4.9
DH76015	3.6	1.7	0.8	0.7	4.4	5.4
DH76022	5.2	2.4	1.1	0.9	4.7	5.8
DH76033	8.0	3.5	1.6	1.3	4.9	6.1
DH76047	11.0	4.9	2.2	1.7	5.0	6.4
DH76068	16.0	7.0	3.1	2.4	5.1	6.5
DH76100	23.0	10.0	4.5	3.5	5.2	6.7
DH76150	35.0	15.0	6.6	5.1	5.2	6.8

### 12 Volt hyperabrupt junction varactors

#### Characteristics @ $T_a = +25^\circ\text{C}$

Reverse breakdown voltage,  $V_b = 12\text{ V min. @ } 10\ \mu\text{A}$   
Reverse Current,  $I_r = 200\ \text{nA @ } 8\text{ V}$

#### Temperature ranges:

Operating junction ( $T_j$ ) :  $-55^\circ\text{C}$  to  $+125^\circ\text{C}$   
Storage :  $-55^\circ\text{C}$  to  $+150^\circ\text{C}$

Test conditions	Total capacitance (pF) Ct			Tuning ratio	
	f = 1 MHz Vr = 1 V	f = 1 MHz Vr = 2.5 V	f=1 MHz Vr = 4 V	Ct1V/Ct2.5V f = 1 MHz	Ct1V/Ct4V f = 1 MHz
	typ	$\pm 20\%$	typ.	typ.	typ.
Type					
DH77033	6.0	3.5	1.9	1.7	3.1
DH77047	8.5	4.9	2.7	1.7	3.2
DH77068	12.0	7.0	3.8	1.7	3.2
DH77100	18.0	10.0	5.5	1.7	3.2
DH77150	27.0	15.0	8.1	1.8	3.3



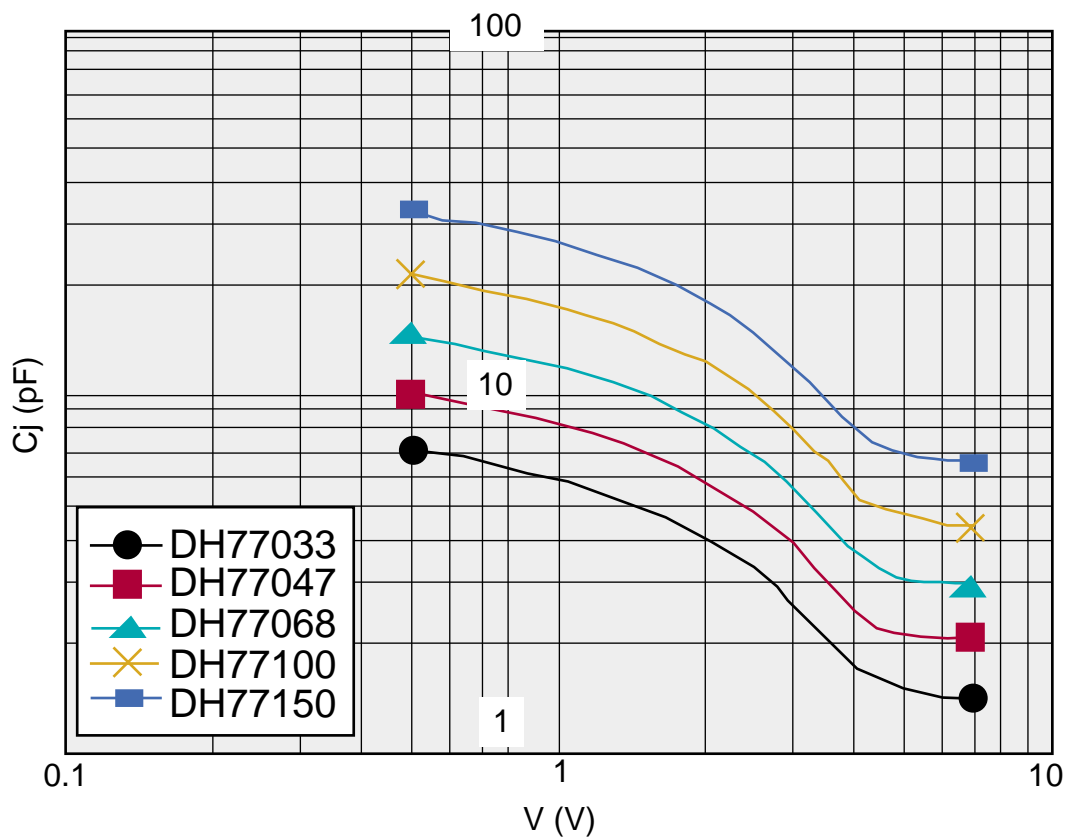
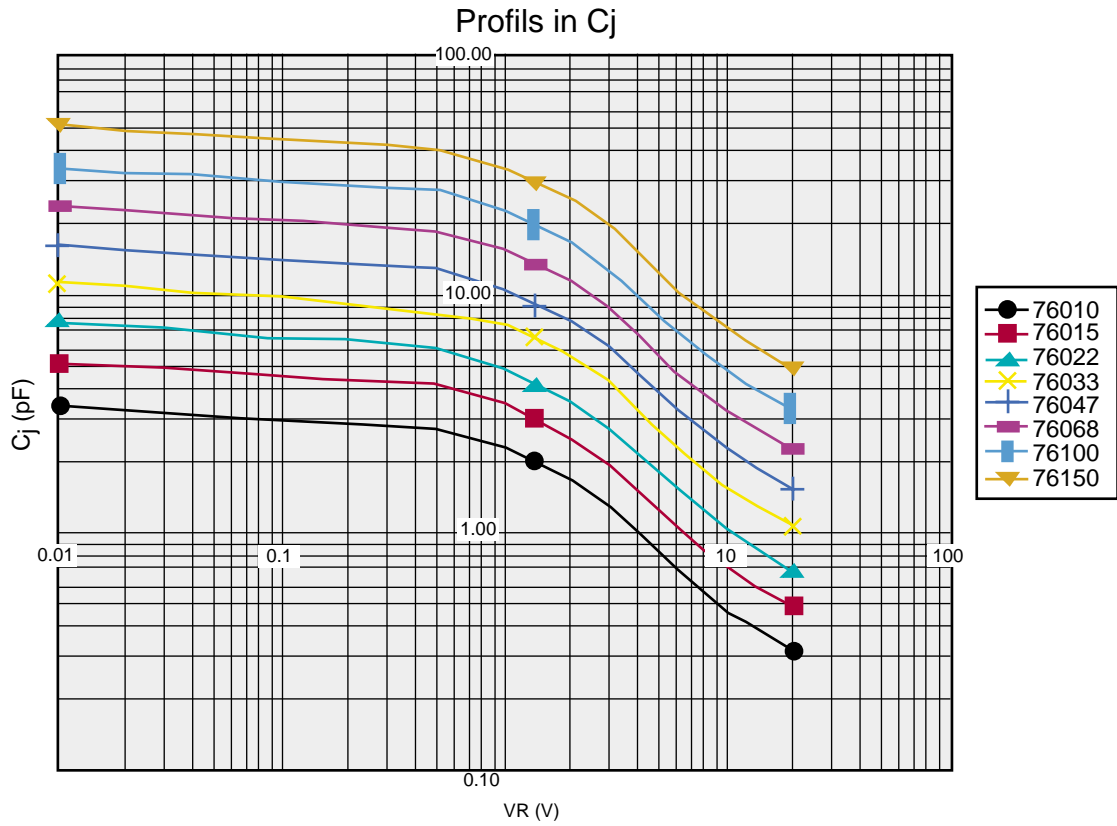

Plastic package, Surface Mount hyperabrupt tuning varactor

Typical junction capacitance versus reverse voltage

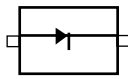

Plastic package, Surface Mount hyperabrupt tuning varactor

**Packages**

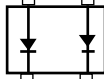
Packages	SOD323 	SOT23 	SOT23 	SOT23 	SOT143 
DH76010	DH76010-60	DH76010-51	DH76010-53	DH76010-54	DH76010-70
DH76015	DH76015-60	DH76015-51	DH76015-53	DH76015-54	DH76015-70
DH76022	DH76022-60	DH76022-51	DH76022-53	DH76022-54	DH76022-70
DH76033	DH76033-60	DH76033-51	DH76033-53	DH76033-54	DH76033-70
DH76047	DH76047-60	DH76047-51	DH76047-53	DH76047-54	DH76047-70
DH76068	DH76068-60	DH76068-51	DH76068-53	DH76068-54	DH76068-70
DH76100	DH76100-60	DH76100-51	DH76100-53	DH76100-54	DH76100-70
DH76150	DH76150-60	DH76150-51	DH76150-53	DH76150-54	DH76150-70
DH77033	DH77033-60	DH77033-51	DH77033-53	DH77033-54	DH77033-70
DH77047	DH77047-60	DH77047-51	DH77047-53	DH77047-54	DH77047-70
DH77068	DH77068-60	DH77068-51	DH77068-53	DH77068-54	DH77068-70
DH77100	DH77100-60	DH77100-51	DH77100-53	DH77100-54	DH77100-70
DH77150	DH77150-60	DH77150-51	DH77150-53	DH77150-54	DH77150-70

(1) Other configuration available on request.

**How to order?**

DH76150	-	51	T3
Diode type		<b>Package information</b> 51: single SOT23 53: dual common cathode SOT23 54: dual common anode SOT23 60: single SOD323 70: dual SOT143	<b>Conditioning</b> T3: 3000 pieces tape & reel T10: 10000 pieces tape & reel blank: bulk

High Q silicon hyperabrupt junction tuning varactor



HIGH Q SILICON HYPERABRUPT JUNCTION TUNING VARACTOR

Description

This series of silicon tuning varactors consists of hyperabrupt epitaxial devices. They incorporate a passivated mesa technology. Packaged or chip devices are available for linear electronic tuning from VHF up to Ku band.

Characteristics @ Ta = +25° C

Reverse breakdown voltage, Vb = @ 10 µA: 20 V min.

Reverse current, Ir @ 16 V: 200 nA

		Figure of merit (Q)	Total capacitance (pF) Ct					Tuning ratio		Chip
Test conditions			f = 50 MHz Vr = 4 V	f = 1 MHz Vr = 1 V	f = 1 MHz Vr = 4 V	f = 1 MHz Vr = 12 V	f = 1 MHz Vr = 20 V	Ct1V/Ct12V f = 1 MHz	Ct1V/CT20V f = 1 MHz	
Type	Case (1)	typ.	typ.	±20%	typ.	typ.	typ.	typ.		
DH76010	F27d	2200	2.5	1.2	0.6	0.5	4.1	4.9	EH76010	
DH76015	F27d	2000	3.6	1.7	0.8	0.7	4.4	5.4	EH76015	
DH76022	F27d	1700	5.2	2.4	1.1	0.9	4.7	5.8	EH76022	
DH76033	F27d	1400	7.7	3.5	1.6	1.3	4.9	6.1	EH76033	
DH76047	F27d	1000	11	4.9	2.2	1.7	5.0	6.4	EH76047	
DH76068	F27d	700	16	6.9	3.0	2.4	5.1	6.5	EH76068	
DH76100	F27d	400	23	10.2	4.5	3.5	5.2	6.7	EH76100	
DH76150	F27d	140	34	15.2	6.6	5.1	5.2	6.8	EH76150	

(1) Custom cases available on request

Temperature ranges:

Operating junction (Tj) : -55° C to +150° C

Storage : -65° C to +150° C

Typical junction capacitance reverse voltage

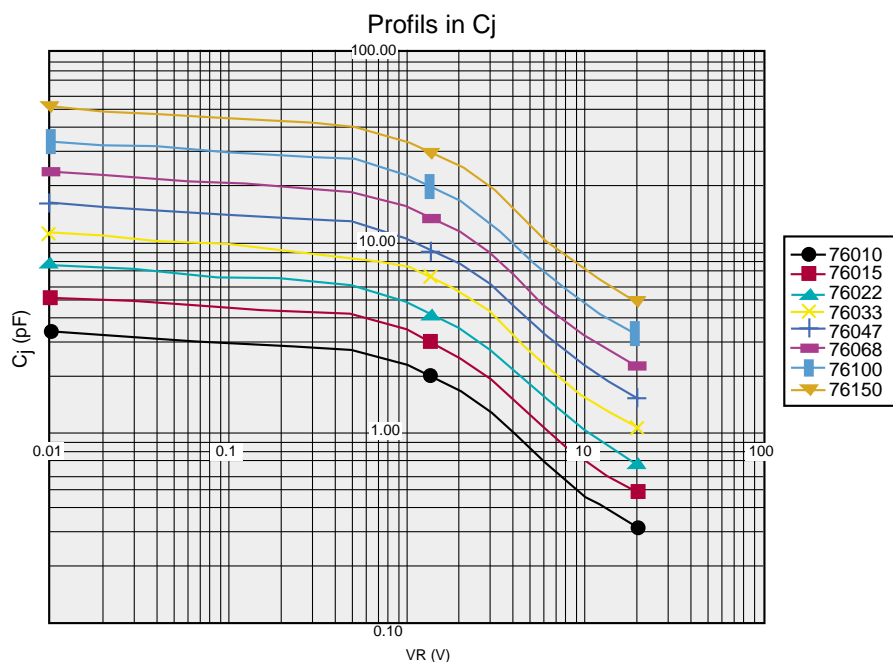

Selection guide



## ▶ POWER GENERATION DIODES

### Selection Guide

	PAGE
<u>STEP RECOVERY DIODES</u>	
- <u>STANDARD</u>	<u>12-42</u>
- <u>SURFACE MOUNT PLASTIC PACKAGES</u>	<u>12-43</u>
<u>SILICON MULTIPLIER VARACTORS</u>	<u>12-45</u>



Step recovery diodes and multiplier varactor applications



## STEP RECOVERY DIODES AND MULTIPLIER VARACTOR APPLICATIONS

A Step Recovery Diode (SRD) generates pulses that can be used to multiply frequencies, and to set up reference points, e.g. for synchronizing test instruments.

This device operates by alternately producing and consuming a charge, based on the frequency of its input signal. During forward bias, the SRD conducts and builds up its charge. During reverse bias, the SRD maintains conduction by consuming its charge. When the charge has been fully consumed, the SRD snaps off, i.e. very quickly reverts to zero conduction.

This device acts as a switch, controlling current flow by alternately storing and releasing its charge, forming pulses at a repetition rate equal to the frequency of its input.

The output of a step recovery diode is most often used in two ways:

- a pulse train can be applied to resonant circuits, which provides output power at a frequency above that of the original input,
- a pulse train can be used to develop a series of frequencies at multiples of the original input frequencies.

Typical applications of step recovery diodes include oscillators, power transmitters and drivers, for telecommunications, telemetry, radar and test equipment.

In choosing a SRD, the significant characteristics include:

Output Frequency ( $f_o$ ) ; Breakdown Voltage ( $V_{BR}$ ) ; Junction Capacitance ( $C_j$ ) ; Minority Carrier Lifetime ( $\tau_l$ ) ; Snap-off Time ( $t_{SO}$ ) ; Thermal Resistance ( $R_{th}$ ) and Output Power ( $P_o$ ).

### *Multiplier varactors*

A multiplier varactor is a physical stack of series-connected SRD units. This configuration is capable of multiplying power.

Packages for multiplier varactors are designed to dissipate the power yield  $\left( \frac{\text{Power out}}{\text{Power in}} \right)$

Most of these packages hold from 2 to 4 chips, this type of components are available on customer request.

## Step recovery diodes (SRD)



## STEP RECOVERY DIODES (S.R.D.)

### Description

These diodes use mesa technology and oxide passivation. They support fast switching and multiplier applications:

- very short pulse generation,
- ultra fast waveform shaping,
- comb generation,
- high order multiplication, at moderate power ratings.

Chip diodes		Chip and packaged diodes						Packaged diodes				
Characteristics at 25°C		Gold dia $\Delta$	Breakdown voltage $V_{br}$	Junction capacitance $C_j$	Min. car. lifetime $t_l$	Snap-Off time $t_{so}$				Thermal resistance $R_{th}$		
Test conditions		N/A	$I_r = 10 \mu A$	$V_r = 6 V$ $f = 1 MHz$	$I_f = 10 mA$ $I_r = 6 mA$	$I_f = 10 mA$ $V_r = 10 V$				$P_{diss} = 1 W$ in F 27d		
Type	Case	$\mu m$	V	pF	ns	ps		Type	Case (1)	°C/W	Other cases (1)	
		typ.	min.	max	min.	typ.	max		$C_b = 0.1 pF$ (2)	max	$C_b = 0.18 pF$ (2)	$C_b = 0.12 pF$ (2)
EH541	C2a	160	30	1.5	25	90	140	DH541	A22e	30	F27d	M208
EH542	C2a	220	50	1.5	40	150	250	DH542	A22e	25	F27d	M208
EH543	C2a	110	30	1.0	20	90	140	DH543	A22e	40	F27d	M208
EH544	C2a	140	50	1.0	35	150	250	DH544	A22e	35	F27d	M208
EH545	C2a	55	25	0.4	10	75	100	DH545	A22e	70	F27d	M208
EH546	C2a	40	15	0.3	6	60	80	DH546	A22e	100	F27d	M208

(1) Custom cases available on request

(2)  $C_T = C_j + C_b$

### Temperature ranges:

Operating junction ( $T_j$ ): -55° C to +150° C

Storage : -65° C to +175° C

Plastic package Surface Mount step recovery diodes

## PLASTIC PACKAGE SURFACE MOUNT S.R.D.

### Description

Our SRD diodes are also available in plastic package. They incorporate a passivated mesa technology. This family is designed for a low cost medium to high volume market that may be supplied in tape and reel for automated pick and place assembly on surface mount circuit boards.

### Application

The DH54X series support fast switching and multiplier applications:

- very short pulse generation
- ultra fast waveform shaping
- comb generation
- high order multiplication at moderate power ratings.



### Temperature ranges

Operating junction (T<sub>J</sub>) : -55°C to +125°C

Storage : -55° C to +150° C

	Breakdown V <sub>br</sub> (V)	Junction capacitance C <sub>j</sub> (pF)	Minority carrier lifetime t <sub>l</sub> (ns)	Snapp-Off time t <sub>SO</sub> (ps)	
Test conditions	I <sub>r</sub> = 10 μA	V <sub>r</sub> = 6 V f = 1 MHz	I <sub>f</sub> = 10 mA I <sub>r</sub> = 6 mA	I <sub>f</sub> = 10 mA V <sub>r</sub> = 10 V	
Type	min.	max.	min.	typ.	max.
DH541	30	1.5	25	90	140
DH542	50	1.5	40	150	250
DH543	30	1.0	20	90	140
DH544	50	1.0	35	150	250
DH545	25	0.4	10	75	100
DH546	15	0.3	6	60	80

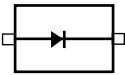
### Packages

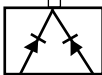
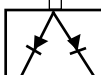
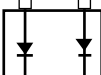
Packages	SOD323	SOT23	SOT23	SOT23	SOT143
					
DH541	DH541-60	DH541-51	DH541-53	DH541-54	DH541-70
DH542	DH542-60	DH542-51	DH542-53	DH542-54	DH542-70
DH543	DH543-60	DH543-51	DH543-53	DH543-54	DH543-70
DH544	DH544-60	DH544-51	DH544-53	DH544-54	DH544-70
DH545	DH545-60	DH545-51	DH545-53	DH545-54	DH545-70
DH546	DH546-60	DH546-51	DH546-53	DH546-54	DH546-70

(1) Other configuration available on request.

Plastic package Surface Mount step recovery diodes

*How to order?*

DH541	-	51	T3
Diode type		<b>Package information</b> 51: single SOT23 53: dual common cathode SOT23 54: dual common anode SOT23 60: single SOD323 70: dual SOT143	<b>Conditioning</b> T3: 3000 pieces tape & reel T10: 10000 pieces tape & reel blank: bulk

## SILICON MULTIPLIER VARACTORS

### Description

These silicon multiplier varactors (from 0.2 to 25 GHz) are designed for harmonic generation of high power levels (stack configuration) and/or at high multiplication orders.

### Packaged diodes

Characteristics at 25°C		Varactor chips per package	Output freq. $F_0$	Breakdown voltage $V_{br}$		Junction capacitance $C_j$		Min. car. lifetime $\tau_i$	Snap-Off time $t_{so}$	Thermal resistance $R_{th}$	Power output $P_o$	
Test Conditions			N/A	$I_R = 10 \mu A$		$V_R = 6 V$ $f = 1 MHz$		$I_F = 10 mA$ $I_R = 6 mA$	$I_F = 10 mA$ $V_R = 10 V$	N/A	$f_o = (n)f_i$	
Type	Case		GHz	V		pF		ns	ps	°C/W	W	(n)
			min.	max	min.	max	min.	max	max	typ.		
DH294	M208b	1	0.2 - 2	45	70	4.0	7.0	125	400	300	0.5	2
DH200	BH142b	1	0.5 - 2	90	140	5.5	7.0	250	1000	8	20.0	2
DH270	S268-W1	1	2 - 3	80	110	4.0	5.5	160	700	10	15.0	2
DH110	F27d	1	2 - 4	60	90	3.0	4.0	100	400	25	9.0	2
DH293	F60d	1	3 - 6	50	70	2.0	3.0	60	250	30	6.0	2
DH252	F27d	1	2 - 8	40	60	0.9	2.0	35	200	50	3.0	2
DH256	F27d	1	5 - 12	30	45	0.5	1.1	20	120	60	2.0	2
DH292	F27d	1	8 - 16	20	35	0.2	0.5	10	75	70	0.6	2
DH267	F27d	1	10 - 25	15	25	0.2	0.3	6	60	100	0.2	2

### Temperature ranges:

Operating junction ( $T_j$ ) : -55° C to +150° C

Storage : -65° C to +175° C



**CASE STYLES**

<b>GENERAL PURPOSE</b>		<b>SURFACE MOUNT DEVICES</b>		<b>STRIP LINE / MICRO STRIP</b>	
	PAGE		PAGE		PAGE
A22e	<a href="#">12-48</a>	SMD3	<a href="#">12-56</a>	BH15	<a href="#">12-48</a>
BH28	<a href="#">12-48</a>	SMD4	<a href="#">12-56</a>	BH16	<a href="#">12-48</a>
BH32	<a href="#">12-48</a>	SMD6	<a href="#">12-56</a>	BH101	<a href="#">12-49</a>
BH35	<a href="#">12-48</a>	SMD8	<a href="#">12-56</a>	BH143	<a href="#">12-50</a>
BH142a	<a href="#">12-49</a>	SOD323	<a href="#">12-56</a>	BH151	<a href="#">12-50</a>
BH142b	<a href="#">12-49</a>	SOT23	<a href="#">12-56</a>	BH152	<a href="#">12-50</a>
BH142c	<a href="#">12-49</a>	SOT143	<a href="#">12-57</a>	BH153	<a href="#">12-50</a>
BH142d	<a href="#">12-49</a>	SOT323	<a href="#">12-57</a>	BH154	<a href="#">12-50</a>
BH142e	<a href="#">12-49</a>			BH155	<a href="#">12-50</a>
BH142f	<a href="#">12-49</a>			BMH76	<a href="#">12-53</a>
BH167	<a href="#">12-51</a>	<b>POWER</b>			
BH167s	<a href="#">12-51</a>		PAGE		
BH198	<a href="#">12-51</a>	BH141	<a href="#">12-49</a>		
F27d	<a href="#">12-54</a>	BH158	<a href="#">12-51</a>	<b>CHIP VERSION</b>	
F30	<a href="#">12-54</a>	BH158am	<a href="#">12-51</a>		PAGE
F51	<a href="#">12-54</a>	BH200a	<a href="#">12-52</a>	C2	<a href="#">12-54</a>
F54	<a href="#">12-54</a>	BH202	<a href="#">12-52</a>	C4	<a href="#">12-54</a>
F54s	<a href="#">12-55</a>	BH203a	<a href="#">12-52</a>		
F60	<a href="#">12-55</a>	BH203b	<a href="#">12-52</a>		
F60d	<a href="#">12-55</a>	BH203c	<a href="#">12-52</a>		
M208a	<a href="#">12-55</a>	BH204	<a href="#">12-52</a>		
M208b	<a href="#">12-55</a>	BH300	<a href="#">12-53</a>		
M208c	<a href="#">12-55</a>	BH301	<a href="#">12-53</a>		
M208d	<a href="#">12-55</a>	BH303	<a href="#">12-53</a>		
M208e	<a href="#">12-55</a>	BH403a	<a href="#">12-53</a>		
M208f	<a href="#">12-56</a>	BH405	<a href="#">12-53</a>		
S268/W1	<a href="#">12-56</a>				
TO39	<a href="#">12-57</a>				
W2	<a href="#">12-57</a>				

Case styles

**A22e**  $C_b=0.1pF$

E	∅ 1.7	∅ 2.1	.067 DIA	.083 DIA
D	∅ 0.35	∅ 0.41	.014 DIA	.016 DIA
C	25.4		1	
B	25.4		1	
A	4	4.4	.157	.173
SYM	min.	max	min.	max
BOL	MILLIMETERS		INCHES	

**BH15**  $C_b=0.1pF$

E	0.09	0.11	.0035	.0043
D	0.28	0.48	.011	.019
C	3.82	4.58	.15	.18
B	0.15	0.35	.006	.014
A	1.17	1.37	.046	.054
SYM	min.	max	min.	max
BOL	MILLIMETERS		INCHES	

**BH16**  $C_b=0.16pF$

E	0.08	0.12	.003	.005
D	0.45	0.55	.018	.022
C	4.58	5.58	.180	.220
B	0.66	0.86	.026	.034
A	2.4	2.6	.094	.102
SYM	min.	max	min.	max
BOL	MILLIMETERS		INCHES	

**BH28**  $C_b=0.2pF$

C	2.04	2.50	.080	.098
B	∅ 1.93	∅ 2.13	.076 DIA	.084 DIA
A	∅ 3.00	∅ 3.20	.118 DIA	.126 DIA
SYM	min.	max	min.	max
BOL	MILLIMETERS		INCHES	

**BH32**  $C_b=0.2pF$

C	3.5	3.9	.138	.154
B	∅ 3.86	∅ 4.26	.152 DIA	.168 DIA
A	∅ 5.64	∅ 6.04	.222 DIA	.238 DIA
SYM	min.	max	min.	max
BOL	MILLIMETERS		INCHES	

**BH35**  $C_b=0.25pF$

H	5.14	5.93	.202	.233
G	1.37	1.77	.054	.070
F	1.78	1.98	.070	.078
E	1.37	1.77	.054	.070
D	∅ 1.52	∅ 1.62	.060 DIA	.064 DIA
C	∅ 3.96	∅ 4.16	.156 DIA	.164 DIA
B	∅ 3.05	∅ 3.25	.120 DIA	.128 DIA
A	∅ 1.52	∅ 1.62	.060 DIA	.064 DIA
SYM	min.	max	min.	max
BOL	MILLIMETERS		INCHES	

BH101  $C_b=0.15pF$

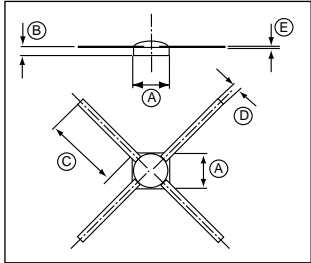

E	0.05	0.15	.002	.006
D	0.55	0.65	.022	.026
C	5		.197	
B	0.28	0.48	.011	.019
A	2.3	2.7	.091	.106
SYM	min.	max	min.	max
BOL	MILLIMETERS		INCHES	

BH141  $C_b=0.4pF$

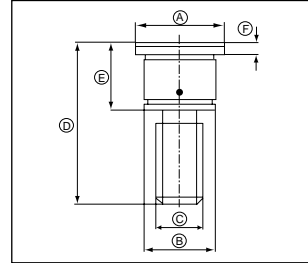

F		0.70		.028
E	4.70	5.10	.185	.201
D	12.8	13.4	.504	.526
C	6.40 UNF-3A			
B	∅ 5.20	∅ 5.40	.205 DIA	.203 DIA
A	∅ 6.50	∅ 6.70	.256 DIA	.263 DIA
SYM	min.	max	min.	max
BOL	MILLIMETERS		INCHES	

BH142a  $C_b=0.2pF$

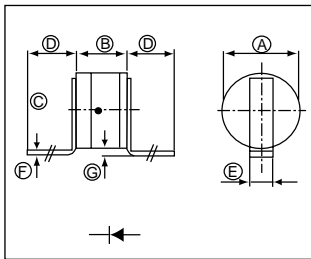

G	0.1	0.5	.004	.020
F	0.06	0.10	.0024	.0039
E	0.55	0.65	.022	.026
D	2.5		.098	
C	2.10	2.70	.083	.106
B	1.24	1.58	.049	.062
A	∅ 1.90	∅ 2.20	.075 DIA	.087 DIA
SYM	min.	max	min.	max
BOL	MILLIMETERS		INCHES	

BH142b  $C_b=0.2pF$

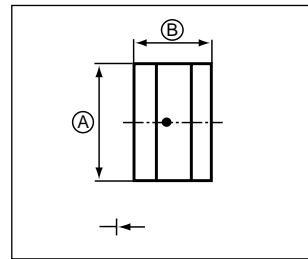

B	1.24	1.58	.049	.062
A	∅ 1.90	∅ 2.20	.075 DIA	.087 DIA
SYM	min.	max	min.	max
BOL	MILLIMETERS		INCHES	

BH142c  $C_b=0.2pF$

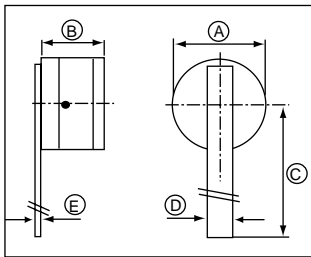

E	0.06	0.10	.0024	.0039
D	0.55	0.65	.022	.026
C	5		.197	
B	1.24	1.58	.049	.062
A	∅ 1.90	∅ 2.20	.075 DIA	.087 DIA
SYM	min.	max	min.	max
BOL	MILLIMETERS		INCHES	

BH142d  $C_b=0.2pF$

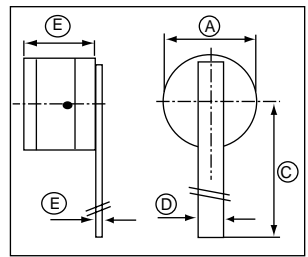

E	0.06	0.10	.0024	.0039
D	0.55	0.65	.022	.026
C	5		.197	
B	1.24	1.58	.049	.062
A	∅ 1.90	∅ 2.20	.075 DIA	.087 DIA
SYM	min.	max	min.	max
BOL	MILLIMETERS		INCHES	

BH142e  $C_b=0.2pF$

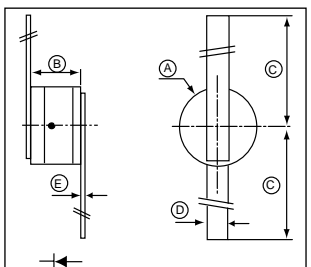

E	0.06	0.10	.0024	.0019
D	0.55	0.65	.022	.026
C	5		.197	
B	1.24	1.58	.049	.062
A	∅ 1.90	∅ 2.20	.075 DIA	.087 DIA
SYM	min.	max	min.	max
BOL	MILLIMETERS		INCHES	

BH142f  $C_b=0.2pF$

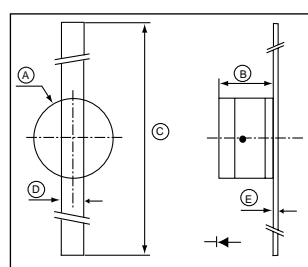

E	0.06	0.10	.0024	.0039
D	0.55	0.65	.022	.026
C	10		.394	
B	1.24	1.58	.049	.062
A	∅ 1.90	∅ 2.20	.075 DIA	.087 DIA
SYM	min.	max	min.	max
BOL	MILLIMETERS		INCHES	



Case styles

BH143  $C_b=0.1\text{pF}$

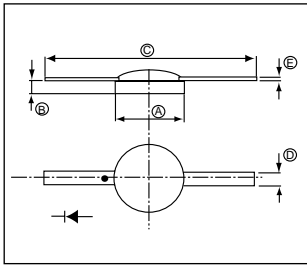

E	0.08	0.12	.003	.005
D	0.45	0.55	.094	.102
C	7.60		.299	
B	0.45	0.55	.018	.022
A	∅ 2.40	∅ 2.60	.094	.102
SYM	min.	max	min.	max
BOL	MILLIMETERS		INCHES	

BH151  $C_b=0.25\text{pF}$

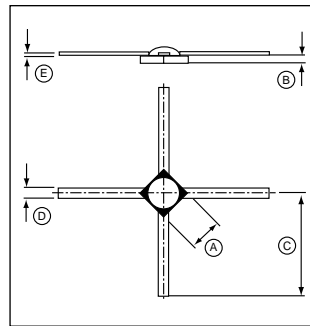

E	0.08	0.12	.003	.005
D	0.35	0.45	.014	.018
C	3.70	4.30	.147	.169
B	0.20	0.30	.008	.012
A	1.17	1.37	.046	.054
SYM	min.	max	min.	max
BOL	MILLIMETERS		INCHES	

BH152  $C_b=0.05\text{pF}$

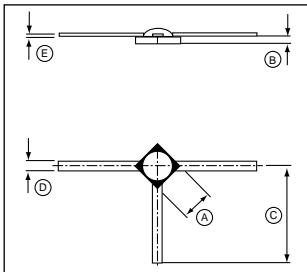

E	0.08	0.12	.003	.005
D	0.35	0.45	.014	.018
C	3.70	4.30	.147	.169
B	0.20	0.30	.008	.012
A	1.17	1.37	.046	.054
SYM	min.	max	min.	max
BOL	MILLIMETERS		INCHES	

BH153  $C_b=0.13\text{pF}$

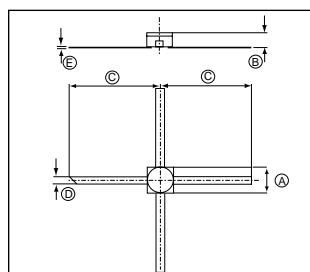

E	0.08	0.12	.003	.005
D	0.45	0.55	.018	.022
C	6.15	6.55	.242	.258
B	0.91	1.01	.036	.040
A	1.68	1.88	.066	.074
SYM	min.	max	min.	max
BOL	MILLIMETERS		INCHES	

BH154  $C_b=0.13\text{pF}$

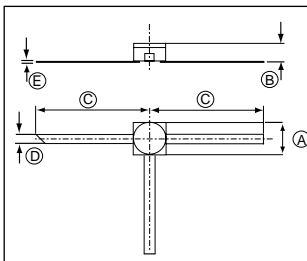

E	0.08	0.12	.003	.005
D	0.45	0.55	.018	.022
C	6.15	6.55	.242	.258
B	0.91	1.01	.036	.040
A	1.68	1.88	.066	.074
SYM	min.	max	min.	max
BOL	MILLIMETERS		INCHES	

BH155  $C_b=0.13\text{pF}$

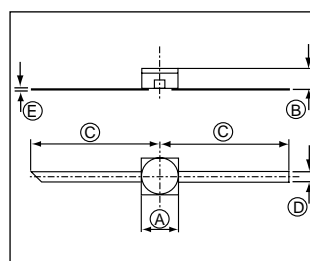

E	0.08	0.12	.003	.005
D	0.45	0.55	.018	.022
C	6.15	6.55	.242	.258
B	0.91	1.01	.036	.040
A	1.68	1.88	.066	.074
SYM	min.	max	min.	max
BOL	MILLIMETERS		INCHES	

BH158  $C_b=0.4\text{pF}$

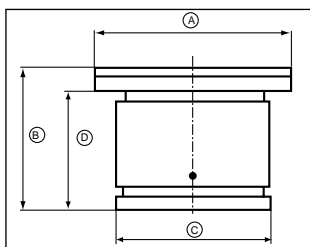

D	4.00	4.50	.157	.177
C	∅ 5.10	∅ 5.50	.200 DIA	.216 DIA
B	4.90	5.30	.193	.209
A	∅ 6.50	∅ 6.70	.256 DIA	.264 DIA
SYM	min.	max	min.	max
BOL	MILLIMETERS		INCHES	

BH158am  $C_b=0.4\text{pF}$

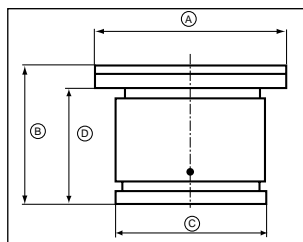

D	4.1	4.4	.16	.173
C	∅ 5.2	∅ 5.5	.204 DIA	.216 DIA
B	4.7	5.2	.185	.205
A	∅ 5.7	∅ 6.1	.224 DIA	.240 DIA
SYM	min.	max	min.	max
BOL	MILLIMETERS		INCHES	

BH167  $C_b=0.12\text{pF}$

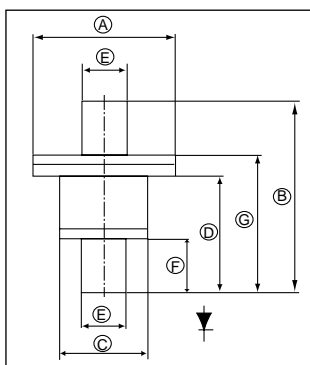

G	1.86	2.06	.073	.081
F	0.71	0.81	.028	.032
E	∅ 0.61	∅ 0.66	.024 DIA	.026 DIA
D	1.55	1.75	.060	.070
C	∅ 1.22	∅ 1.32	.048 DIA	.052 DIA
B	2.57	2.87	.101	.113
A	∅ 1.42	∅ 1.62	.056 DIA	.064 DIA
SYM	min.	max	min.	max
BOL	MILLIMETERS		INCHES	

BH167s  $C_b=0.12\text{pF}$

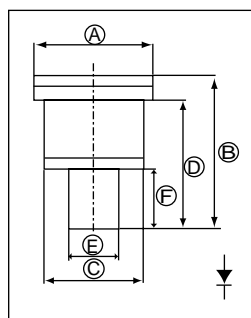

F	0.71	0.81	.028	.032
E	∅ 0.61	∅ 0.66	.024 DIA	.026 DIA
D	1.55	1.75	.061	.069
C	∅ 1.22	∅ 1.32	.048 DIA	.052 DIA
B	1.86	2.06	.073	.081
A	∅ 1.42	∅ 1.62	.056 DIA	.064 DIA
SYM	min.	max	min.	max
BOL	MILLIMETER		INCHES	

BH198  $C_b=0.6\text{pF}$

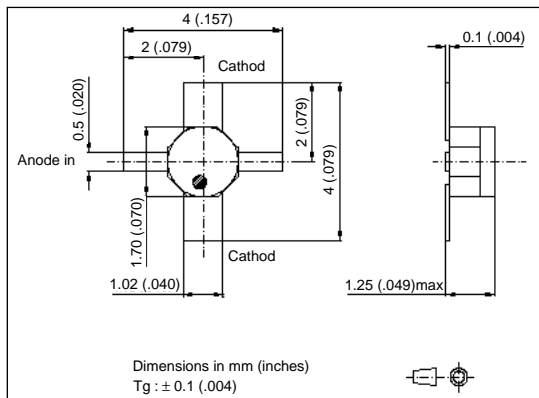

L	4		.157	
D1	1.55	1.75	.06	.069
D	1.68	1.88	.066	.074
C	0.07	0.15	.003	.006
B2	0.4	0.6	.016	.024
B1	0.92	1.12	.036	.044
A1	0.86	1.25	.034	.049
A	0.66	0.86	.026	.034
SYM	min.	max	min.	max
BOL	MILLIMETER		INCHES	

Case styles



$C_b=0.4\text{pF}$

BH200a

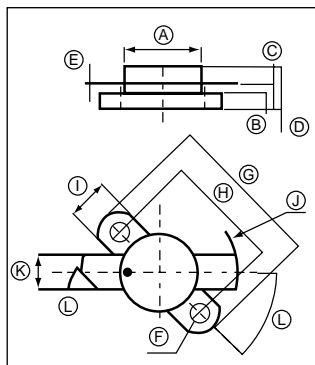

L	43°	47°	43°	47°
K	5.49	5.89	.216	.232
J	∅ 30.48	∅ 31.50	1.200 DIA	1.240 DIA
I	6.30	6.40	.248	.252
H	18.26	18.67	.719	.735
G	24.64	24.89	.970	.980
F	∅ 3.10	∅ 3.25	.122 DIA	.128 DIA
E	0.10	0.127	.004	.005
D	6.78	7.19	.267	.283
C	3.86	4.27	.152	.168
B	2.50	2.667	.098	.105
A	∅ 12.50	∅ 12.90	.492 DIA	.508 DIA
SYM	min.	max	min.	max
BOL	MILLIMETERS		INCHES	

$C_b=0.15\text{pF}$

BH202

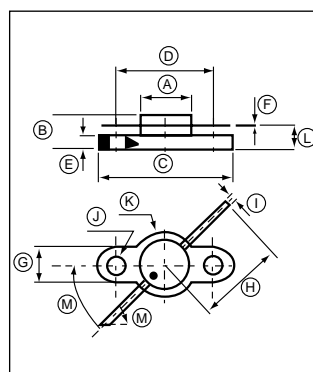

M	43°	47°	43°	47°
L	4.12	4.52	.162	.178
K	∅ 12.14	∅ 12.24	.478 DIA	.482 DIA
J	∅ 3.10	∅ 3.25	.122 DIA	.128 DIA
I	1.25	1.29	.049	.051
H	16.30	16.70	.642	.658
G	6.30	6.40	.248	.252
F	0.23	0.27	.009	.011
E	2.50	2.67	.098	.105
D	18.26	18.67	.719	.735
C	24.64	24.89	.970	.980
B	6.78	7.19	.267	.283
A	∅ 9.4	∅ 9.64	.370 DIA	.380 DIA
SYM	min.	max	min.	max
BOL	MILLIMETERS		INCHES	

$C_b=0.15\text{pF}$

BH203a

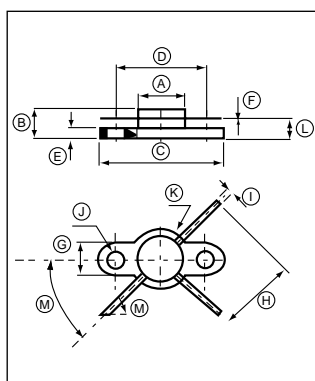

M	43°	47°	43°	47°
L	4.12	4.52	.162	.178
K	∅ 12.14	∅ 12.24	.478 DIA	.482 DIA
J	∅ 3.10	∅ 3.25	.122 DIA	.128 DIA
I	1.25	1.29	.049	.051
H	16.30	16.70	.642	.658
G	6.30	6.40	.248	.252
F	0.23	0.27	.009	.011
E	2.50	2.67	.098	.105
D	18.26	18.67	.719	.735
C	24.64	24.89	.970	.980
B	6.78	7.19	.267	.283
A	∅ 9.4	∅ 9.64	.370 DIA	.380 DIA
SYM	min.	max	min.	max
BOL	MILLIMETERS		INCHES	

$C_b=0.15\text{pF}$

BH203b

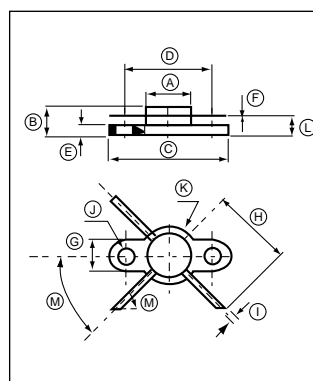

M	43°	47°	43°	47°
L	4.12	4.52	.162	.178
K	∅ 12.14	∅ 12.24	.478 DIA	.482 DIA
J	∅ 3.10	∅ 3.25	.122 DIA	.128 DIA
I	1.25	1.29	.049	.051
H	16.30	16.70	.642	.658
G	6.30	6.40	.248	.252
F	0.23	0.27	.009	.011
E	2.50	2.67	.098	.105
D	18.26	18.67	.719	.735
C	24.64	24.89	.970	.980
B	6.78	7.19	.267	.283
A	∅ 9.4	∅ 9.64	.370 DIA	.380 DIA
SYM	min.	max	min.	max
BOL	MILLIMETERS		INCHES	

$C_b=0.15\text{pF}$

BH203c

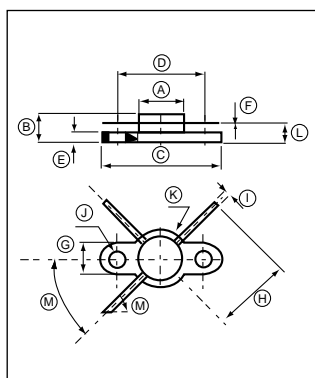

M	43°	47°	43°	47°
L	4.12	4.52	.162	.178
K	∅ 12.14	∅ 12.24	.478 DIA	.482 DIA
J	∅ 3.10	∅ 3.25	.122 DIA	.128 DIA
I	1.25	1.29	.049	.051
H	16.30	16.70	.642	.658
G	6.30	6.40	.248	.252
F	0.23	0.27	.009	.011
E	2.50	2.67	.098	.105
D	18.26	18.67	.719	.735
C	24.64	24.89	.970	.980
B	6.78	7.19	.267	.283
A	∅ 9.4	∅ 9.64	.370 DIA	.380 DIA
SYM	min.	max	min.	max
BOL	MILLIMETERS		INCHES	

$C_b=0.15\text{pF}$

BH204

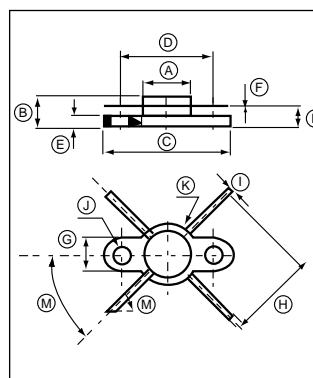

M	43°	47°	43°	47°
L	4.12	4.52	.162	.178
K	∅ 12.14	∅ 12.24	.478 DIA	.482 DIA
J	∅ 3.10	∅ 3.25	.122 DIA	.128 DIA
I	1.25	1.29	.049	.051
H	16.30	16.70	.642	.658
G	6.30	6.40	.248	.252
F	0.23	0.27	.009	.011
E	2.50	2.67	.098	.105
D	18.26	18.67	.719	.735
C	24.64	24.89	.970	.980
B	6.78	7.19	.267	.283
A	∅ 9.4	∅ 9.64	.370 DIA	.380 DIA
SYM	min.	max	min.	max
BOL	MILLIMETERS		INCHES	

BH300  $C_b=0.4\text{pF}$

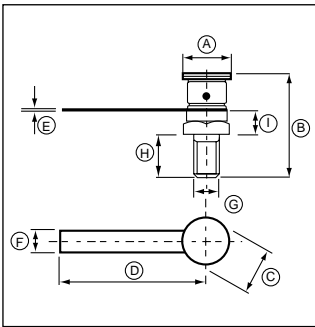

I	3.25	3.45	.128	.136
H	5.60	6.00	.220	.236
G	6 - 32 UNC - 3A			
F	2.97	3.38	.177	.133
E	0.20	0.30	.008	.012
D	20	-	.787	-
C	6.30	6.40	.248	.252
B	13.95	15.05	.549	.593
A	∅ 6.5	∅ 6.7	.256 DIA	.264 DIA
SYM	min.	max	min.	max
BOL	MILLIMETERS		INCHES	

BH301  $C_b=0.2\text{pF}$

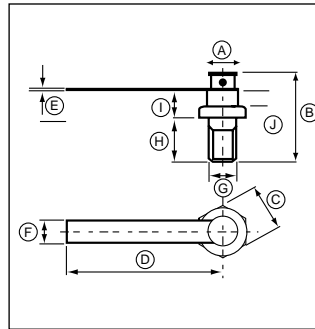

J	1.52	1.62	.060	.064
I	2.82	3.02	.111	.119
H	4.42	4.82	.174	.190
G	4 - 40 LNC - 3A			
F	2.16	2.56	.85	.101
E	0.18	0.20	.007	.008
D	15.67	16.18	.617	.637
C	4.70	4.80	.185	.189
B	9.46	10.54	.372	.415
A	∅ 3.00	∅ 3.20	.118 DIA	.126 DIA
SYM	min.	max	min.	max
BOL	MILLIMETERS		INCHES	

BH303  $C_b=0.4\text{pF}$

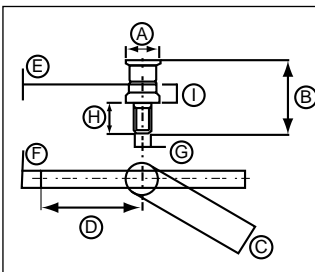

I	3.25	3.45	.128	.136
H	5.60	6.00	.220	.236
G	6 - 32 UNC - 3A			
F	2.97	3.38	.177	.133
E	0.20	0.30	.008	.012
D	20	-	.787	-
C	6.30	6.40	.248	.252
B	13.95	15.05	.549	.593
A	∅ 6.5	∅ 6.7	.256 DIA	.264 DIA
SYM	min.	max	min.	max
BOL	MILLIMETERS		INCHES	

BH403a  $C_b=0.3\text{pF}$

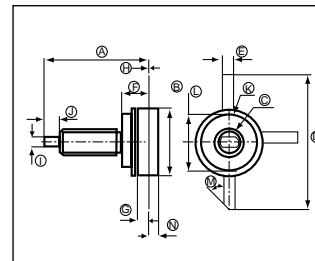

N	-	3	-	.120
M	Typical: 45°			
L	9.68	10.08	.381	.397
K	∅ 10.46	∅ 10.87	.412 DIA	.428 DIA
J	2.72	3.12	.107	.123
I	1.57	1.98	.062	.078
H	0.10	0.15	.004	.006
G	1.78	2.03	.070	.080
F	4.39	4.64	.173	.183
E	1.90	2.16	.075	.085
D	25.4	-	1	-
C	10 - 32 UNF 3A			
B	∅ 12.50	∅ 12.90	.492 DIA	.508
A	18.67	19.43	.735	.765
SYM	min.	max	min.	max
BOL	MILLIMETERS		INCHES	

BH405  $C_b=0.4\text{pF}$

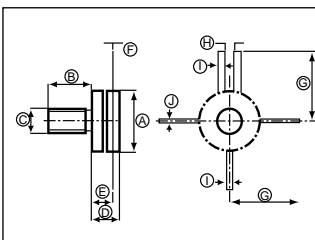

J	0.97	1.07	.038	.042
I	2.49	2.59	.098	.102
H	2.9	3.1	.114	.122
G	22.4	22.6	.882	.890
F	0.20	0.30	.0079	.0118
E	6.1	6.5	.240	.256
D	9.2	9.6	.362	.378
C	5/16 - 24 UNF - 2A			
B	14	14.2	.551	.559
A	∅ 19.6	∅ 19.8	.772 DIA	.780 DIA
SYM	min.	max	min.	max
BOL	MILLIMETERS		INCHES	

BMH76  $C_b=0.15\text{pF}$

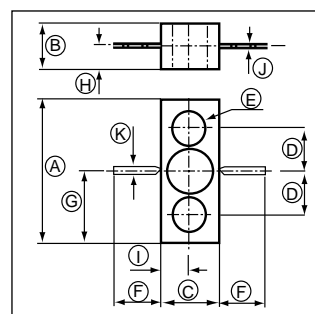

K	0.50	0.70	.020	.028
J	0.20	0.24	.008	.010
I	1.95	2.15	.077	.085
H	1.47	1.67	.058	.066
G	5.1	5.3	.201	.209
F	3.18	3.68	.125	.145
E	∅ 2.36	∅ 2.52	.093 DIA	.099 DIA
D	3.1	3.3	.122	.130
C	4	4.2	.157	.165
B	3.02	3.22	.119	.127
A	10.3	10.5	.406	.413
SYM	min.	max	min.	max
BOL	MILLIMETERS		INCHES	

Case styles

C2

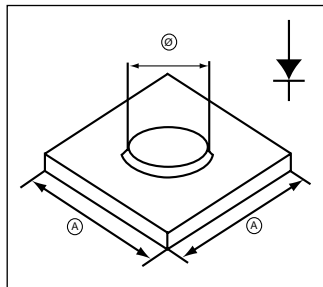

C2J	1740	1800	68.50	70.87
C2H	1440	1500	56.69	59.06
C2G	1140	1200	44.88	47.24
C2E	940	1000	37.01	39.37
C2D	840	900	33.07	35.43
C2C	740	800	29.13	31.50
C2B	540	600	21.26	23.62
C2A	340	400	13.39	15.75
CON	min.	max	min.	max
FIG	A (µm)		A (µ")	

C4

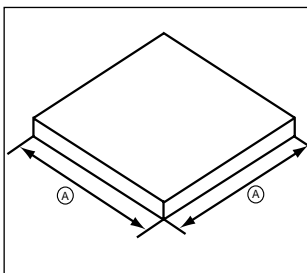

C4G	1500	2500	59.06	98.43
C4F	1000	1500	39.37	59.06
C4E	700	1000	27.56	39.37
C4D	500	700	19.69	27.56
C4C	400	500	15.75	19.69
C4B	300	400	11.81	15.75
C4A	200	300	7.87	11.81
CON	min.	max	min.	max
FIG	A (µm)		A (µ")	

F27d

$C_b=0.18pF$

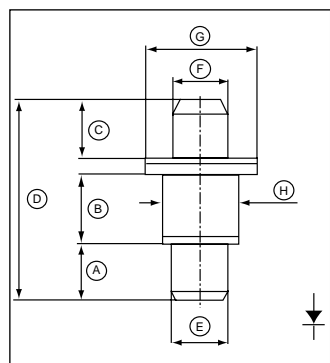

H	∅ 2.01	∅ 2.05	.079 DIA	.081 DIA
G	∅ 2.95	∅ 3.15	.116 DIA	.124 DIA
F	∅ 1.55	∅ 1.59	.061 DIA	.063 DIA
E	∅ 1.55	∅ 1.59	.061 DIA	.063 DIA
D	5.15	5.65	.202	.222
C	1.55	1.59	.061	.063
B	1.74	1.82	.069	.072
A	1.55	1.59	.061	.063
SYM	min.	max	min.	max
BOL	MILLIMETERS		INCHES	

F30

$C_b=0.25pF$

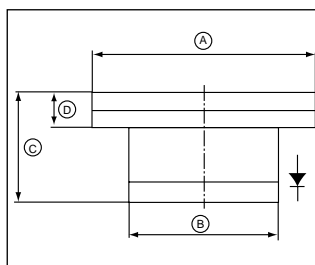

D	0.4	0.6	.016	.024
C	1.4	1.6	.055	.063
B	∅ 1.93	∅ 2.13	.076 DIA	.084 DIA
A	∅ 2.94	∅ 3.14	.116 DIA	.124 DIA
SYM	min.	max	min.	max
BOL	MILLIMETERS		INCHES	

F51

$C_b=0.1pF$

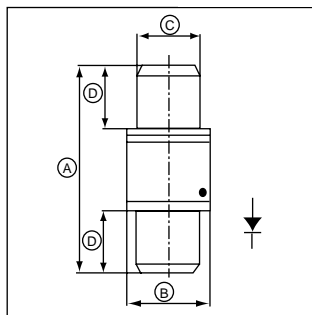

D	1.47	1.67	.058	.066
C	∅ 1.47	∅ 1.67	.058 DIA	.066 DIA
B	∅ 1.93	∅ 2.13	.076 DIA	.084 DIA
A	4.9	5.3	.193	.209
SYM	min.	max	min.	max
BOL	MILLIMETERS		INCHES	

F54

$C_b=0.2pF$

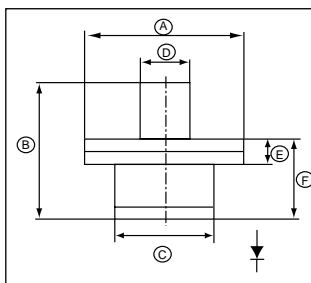

F	1.0	1.2	.039	.047
E	0.40	0.47	.016	.019
D	∅ 0.61	∅ 0.66	.024 DIA	.029 DIA
C	∅ 1.19	∅ 1.35	.047 DIA	.053 DIA
B	1.70	2.00	.067	.079
A	∅ 2.00	∅ 2.16	.079 DIA	.085 DIA
SYM	min.	max	min.	max
BOL	MILLIMETER		INCHES	

F54s  $C_b=0.2pF$

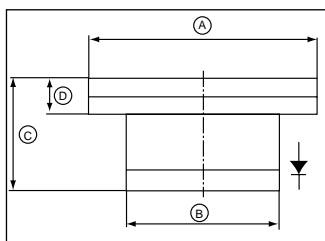

D	0.36	0.46	.014	.018
C	0.84	0.94	.073	.047
B	∅ 1.19	∅ 1.35	.047 DIA	.053 DIA
A	∅ 2.00	∅ 2.16	.079 DIA	.085 DIA
SYM	min.	max	min.	max
BOL	MILLIMETERS		INCHES	

F60  $C_b=0.2pF$

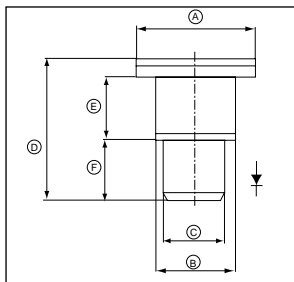

F	1.51	1.63	.059	.064
E	1.81	1.95	.071	.077
D	3.76	4.21	.148	.166
C	∅ 1.52	∅ 1.62	.060 DIA	.064 DIA
B	∅ 1.93	∅ 2.13	.076 DIA	.084 DIA
A	∅ 2.95	∅ 3.15	.116 DIA	.124 DIA
SYM	min.	max	min.	max
BOL	MILLIMETER		INCHES	

F60d  $C_b=0.25pF$

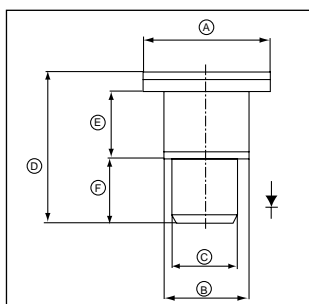

F	1.52	1.64	.060	.065
E	0.95	1.09	.037	.043
D	2.91	3.36	.115	.132
C	∅ 1.52	∅ 1.62	.060 DIA	.064 DIA
B	∅ 1.93	∅ 2.13	.076 DIA	.084 DIA
A	∅ 2.95	∅ 3.15	.116 DIA	.124 DIA
SYM	min.	max	min.	max
BOL	MILLIMETER		INCHES	

M208a  $C_b=0.12pF$

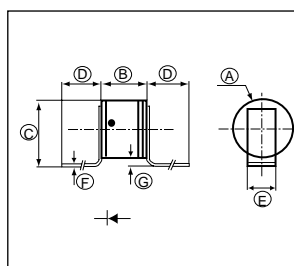

G	0.1	0.4	.004	.015
F	0.06	0.1	.0024	.004
E	0.55	0.65	.022	.026
D	2.5		.100	
C	1.3	1.7	.052	.068
B	0.95	1.35	.037	.053
A	∅ 1.07	∅ 1.47	.042 DIA	.058 DIA
SYM	min.	max	min.	max
BOL	MILLIMETER		INCHES	

M208b

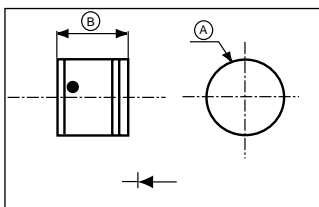

$C_b=0.12pF$

B	0.95	1.35	.037	.053
A	∅ 1.07	∅ 1.47	.042 DIA	.058 DIA
SYM	min.	max	min.	max
BOL	MILLIMETERS		INCHES	

M208c  $C_b=0.12pF$

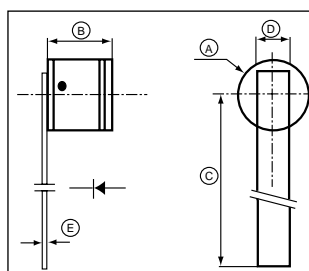

E	0.06	0.1	.0024	.004
D	0.55	0.65	.022	.026
C	5		.200	
B	0.95	1.35	.037	.053
A	∅ 1.07	∅ 1.47	.042 DIA	.058 DIA
SYM	min.	max	min.	max
BOL	MILLIMETERS		INCHES	

M208d

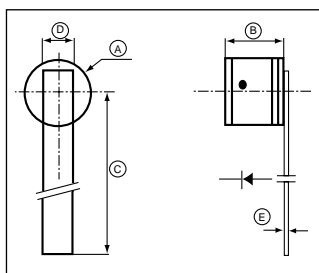

$C_b=0.12pF$

E	0.06	0.1	.0024	.004
D	0.55	0.65	.022	.026
C	5		.200	
B	0.95	1.35	.037	.053
A	∅ 1.07	∅ 1.47	.042 DIA	.058 DIA
SYM	min.	max	min.	max
BOL	MILLIMETERS		INCHES	

M208e

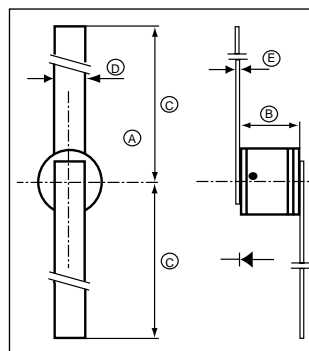

$C_b=0.12pF$

E	0.06	0.1	.0024	.004
D	0.55	0.65	.022	.026
C	5		.200	
B	0.95	1.35	.037	.053
A	∅ 1.07	∅ 1.47	.042 DIA	.058 DIA
SYM	min.	max	min.	max
BOL	MILLIMETERS		INCHES	

Case styles



M208f  $C_b=0.12pF$

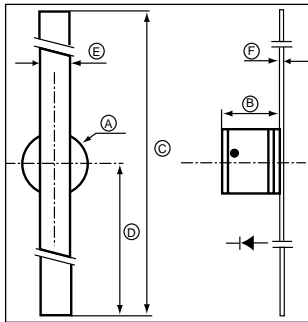

F	0.06	0.1	.0024	.004
E	0.55	0.65	.022	.026
D	5		.200	
C	9.8	10.2	.392	.408
B	0.95	1.35	.037	.053
A	∅ 1.07	∅ 1.47	.042 DIA	.058 DIA
SYM	min.	max	min.	max
BOL	MILLIMETER		INCHES	

S268/W1  $C_b=0.2pF$

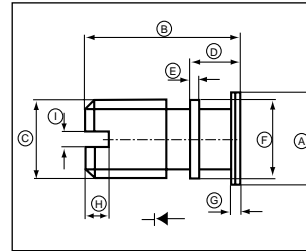

I	0.38	0.62	.015	.024
H	0.64	0.88	.025	.035
G	0.51	0.60	.020	.024
F	∅ 2.44	∅ 2.64	.096 DIA	.104 DIA
E	0.21	0.31	.008	.012
D	1.71	2.00	.067	.079
C	3 - 48 UNC 2A			
B	5.01	5.46	.197	.215
A	∅ 2.85	∅ 3.25	.112 DIA	.128 DIA
SYM	min.	max	min.	max
BOL	MILLIMETER		INCHES	

SMD3  $C_b=0.11pF$

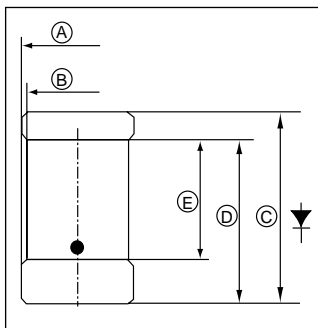

E	2.69	2.89	.106	.114
D	3.71	3.91	.146	.154
C	4.4	4.6	.173	.181
B	∅ 2.19	∅ 2.39	.086 DIA	.094 DIA
A	∅ 2.44	∅ 2.64	.096 DIA	.104 DIA
SYM	min.	max	min.	max
BOL	MILLIMETERS		INCHES	

SMD4  $C_b=0.24pF$

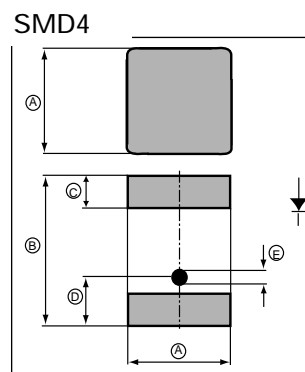

E	Typical 0.2		Typical .008	
D	Typical 1		Typical .039	
C	0.3	0.8	.012	.031
B	2.9	3.5	.114	.138
A	2	2.3	.079	.091
SYM	min.	max	min.	max
BOL	MILLIMETERS		INCHES	

SMD6  $C_b=0.24pF$

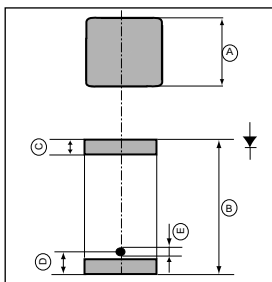

E	Typical 0.20		Typical .008	
D	Typical 1.20		Typical .047	
C	0.3	0.8	.012	.031
B	4.70	5.2	.185	.205
A	2.5	2.8	.098	.110
SYM	min.	max	min.	max
BOL	MILLIMETERS		INCHES	

SMD8

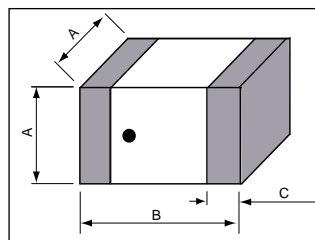

B	4.70	5.2	.185	.205
C	0.20	0.38	.008	.015
SYM	min.	max	min.	max
BOL	MILLIMETERS		INCHES	

SOD323

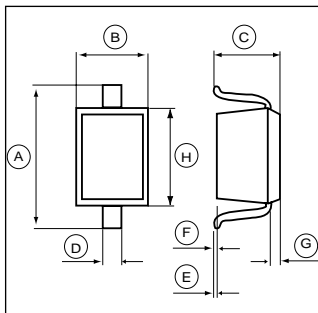

H	1.70	.0669
G	0.20	.0078
F	0.15	.0059
E	0.05	.0020
D	0.30	.0118
C	1.10	.043
B	1.25	.049
A	2.50	.098
SYM	Typical	Typical
BOL	MILLIMETERS	INCHES

SOT23  $C_b=0.2pF$

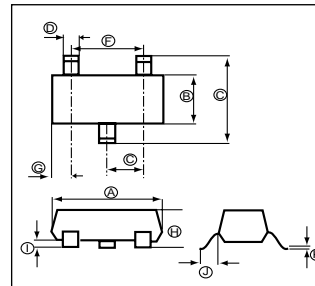

K	0.1	0.13	0.004	0.005
J	0.53	0.56	0.021	0.022
I	0.05	0.1	0.002	0.0004
H	1.07	1.14	0.042	0.045
G	0.43	0.46	0.017	0.018
F	1.78	2.04	0.070	0.080
E	0.94 typ.		0.037 typ.	
D	0.43	0.45	0.017	0.020
C	2.36	2.49	0.093	0.098
B	1.3	1.35	0.051	0.053
A	2.84	3.02	0.112	0.119
SYM	min.	max	min.	max
BOL	Millimeters	Millimeters	Inches	Inches

SOT143

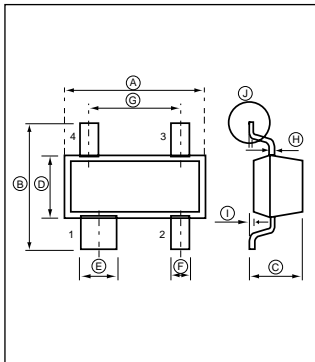

J	max 8°	
I	0.10	.0039
H	0.12	.0047
G	1.90	.0075
F	0.40	.0157
E	0.80	.0315
D	1.30	.051
C	1.10	.043
B	2.60	.102
A	2.90	.114
SYM	Typical	Typical
BOL	MILLIMETERS	INCHES

SOT323

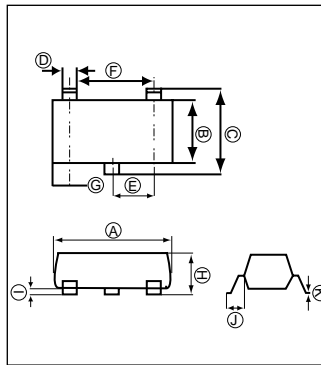

K	0.12	.0047
J	0.43	.017
I	0.1 max.	.004 max.
H	0.9	.035
G	0.3	.012
F	1.3	.051
E	0.65	.026
D	0.3	.012
C	2.1	.083
B	1.25	.043
A	1.9	.075
SYM	Typical	Typical
BOL	MILLIMETERS	INCHES

TO39

C<sub>b</sub>=0.2pF

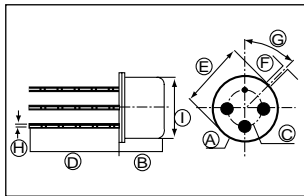

I	∅ 8.3	∅ 8.5	.327 DIA	.335 DIA
H	∅ 0.41	∅ 0.48	.016 DIA	.019 DIA
G	44°	46°	44°	46°
F	0.71	0.81	.028	.032
E	9.40	10.40	.370	.409
D	12.7		.500	
C	4.98	5.18	.196	.204
B	6.30	6.40	.248	.252
A	∅ 9.10	∅ 9.30	.358 DIA	.366 DIA
SYM	min.	max	min.	max
BOL	MILLIMETER		INCHES	

W2

C<sub>b</sub>=0.15pF

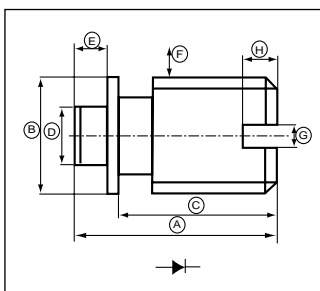

H	0.71	0.81	.028	.032
G	0.45	0.55	.020	.022
F	3 - 48 UNC - 3A			
E	0.61	0.81	.024	.032
D	∅ 1.17	∅ 1.37	.046 DIA	.054 DIA
C	3.40	3.60	.134	.142
B	∅ 2.46	∅ 2.66	.097 DIA	.105 DIA
A	4.38	4.68	.172	.184
SYM	min.	max	min.	max
BOL	MILLIMETERS		INCHES	