

# SI-8000S Series Full-Mold, Separate Excitation Step-down Switching Mode

## Features

- Compact full-mold package (equivalent to TO220)
- Output current: 3.0A
- High efficiency: 79 to 91%
- Requires only 4 discrete components
- Internally-adjusted phase correction and output voltage
- Built-in reference oscillator (60kHz)
- Built-in overcurrent and thermal protection circuits
- Built-in soft start circuit (Output ON/OFF available)

## Lineup

Part Number	SI-8033S	SI-8050S	SI-8090S	SI-8120S	SI-8150S
Vo(V)	3.3	5.0	9.0	12.0	15.0
Io(A)	3.0				

## Absolute Maximum Ratings

Parameter	Symbol	Ratings	Unit
DC Input Voltage	V <sub>IN</sub>	43*	V
Power Dissipation	P <sub>D1</sub>	18(With infinite heatsink)	W
	P <sub>D2</sub>	1.5(Without heatsink, stand-alone operation)	W
Junction Temperature	T <sub>j</sub>	+125	°C
Storage Temperature	T <sub>stg</sub>	-40 to +125	°C
SW Terminal Applied Reverse Voltage	V <sub>SW</sub>	-1	V
Thermal Resistance(junction to case)	θ <sub>J-C</sub>	5.5	°C/W

\*35V for SI-8033S

## Applications

- Power supplies for telecommunication equipment
- Onboard local power supplies

## Recommended Operating Conditions

Parameter	Symbol	Ratings					Unit
		SI-8033S	SI-8050S	SI-8090S	SI-8120S	SI-8150S	
DC Input Voltage Range	V <sub>IN</sub>	5.5 to 28	7 to 40	12 to 40	15 to 40	18 to 40	V
Output Current Range	I <sub>o</sub>	0 to 3.0					A
Operating Junction Temperature Range	T <sub>JP</sub>	-30 to +125					°C

## Electrical Characteristics

(T<sub>a</sub>=25°C)

Parameter	Symbol	Ratings															Unit
		SI-8033S			SI-8050S			SI-8090S			SI-8120S			SI-8150S			
Output Voltage	Vo	min.	typ.	max.	min.	typ.	max.	min.	typ.	max.	min.	typ.	max.	min.	typ.	max.	V
		3.17	3.30	3.43	4.80	5.00	5.20	8.55	9.00	9.45	11.50	12.00	12.50	14.25	15.00	15.75	
Efficiency	η	Conditions			Conditions			Conditions			Conditions			Conditions			%
		V <sub>IN</sub> =15V, I <sub>o</sub> =1.0A			V <sub>IN</sub> =20V, I <sub>o</sub> =1.0A			V <sub>IN</sub> =21V, I <sub>o</sub> =1.0A			V <sub>IN</sub> =24V, I <sub>o</sub> =1.0A			V <sub>IN</sub> =25V, I <sub>o</sub> =1.0A			
Oscillation Frequency	f	Conditions			Conditions			Conditions			Conditions			Conditions			kHz
		V <sub>IN</sub> =15V, I <sub>o</sub> =1.0A			V <sub>IN</sub> =20V, I <sub>o</sub> =1.0A			V <sub>IN</sub> =21V, I <sub>o</sub> =1.0A			V <sub>IN</sub> =24V, I <sub>o</sub> =1.0A			V <sub>IN</sub> =25V, I <sub>o</sub> =1.0A			
Line Regulation	ΔV <sub>OLINE</sub>	Conditions			Conditions			Conditions			Conditions			Conditions			mV
		V <sub>IN</sub> =8 to 28V, I <sub>o</sub> =1.0A			V <sub>IN</sub> =10 to 30V, I <sub>o</sub> =1.0A			V <sub>IN</sub> =15 to 30V, I <sub>o</sub> =1.0A			V <sub>IN</sub> =18 to 30V, I <sub>o</sub> =1.0A			V <sub>IN</sub> =21 to 30V, I <sub>o</sub> =1.0A			
Load Regulation	ΔV <sub>OLOAD</sub>	Conditions			Conditions			Conditions			Conditions			Conditions			mV
		V <sub>IN</sub> =15V, I <sub>o</sub> =0.5 to 1.5A			V <sub>IN</sub> =20V, I <sub>o</sub> =0.5 to 1.5A			V <sub>IN</sub> =21V, I <sub>o</sub> =0.5 to 1.5A			V <sub>IN</sub> =24V, I <sub>o</sub> =0.5 to 1.5A			V <sub>IN</sub> =25V, I <sub>o</sub> =0.5 to 1.5A			
Temperature Coefficient of Output Voltage	ΔVo/ΔTa	±0.5			±0.5			±1.0			±1.0			±1.0			mV/°C
Overcurrent Protection Starting Current	I <sub>st</sub>	3.1			3.1			3.1			3.1			3.1			A
		Conditions			Conditions			Conditions			Conditions			Conditions			
Soft Start Pin*2	Low-Level Voltage	V <sub>SSL</sub>			0.2			0.2			0.2			0.2			V
		Conditions			Conditions			Conditions			Conditions			Conditions			
Soft Start Pin*2	Outflow Current at Low Voltage	I <sub>SSL</sub>			15			25			35			35			μA
		V <sub>SSL</sub> =0.2V															

\*1: "S" may be printed to the right of the marking (except SI-8090S, SI-8120S, SI-8150S).

\*2: Pin 5 is a soft start pin. Soft start at power on can be performed with a capacitor connected to this pin.

The output can also be turned ON/OFF with this pin.

The output is stopped by setting the voltage of this pin to V<sub>SSL</sub> or lower.

Soft-start pin voltage can be changed with an open-collector drive circuit of a transistor.

When using both the soft-start and ON/OFF functions together, the discharge current from C<sub>3</sub> flows into the ON/OFF control transistor. Therefore, limit the current securely to protect the transistor if C<sub>3</sub> capacitance is large.

The ON/OFF pin is pulled up to the power supply in the IC, so applying the external voltage is prohibited.

If this pin is not used, leave it open.

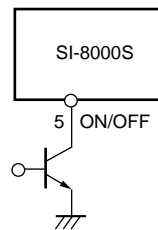

V<sub>OUT</sub>. ON/OFF

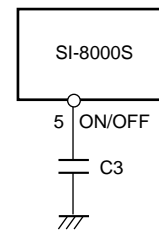

Soft start

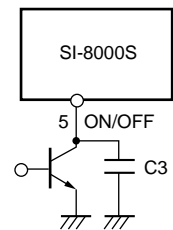

Soft start +V<sub>OUT</sub>. ON/OFF

External Dimensions (TO220F-5)

(Unit : mm)

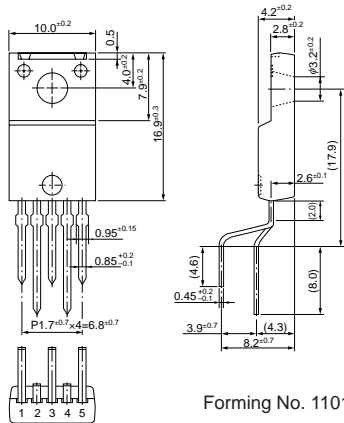

Pin Assignment

- ① VIN
- ② SWOut
- ③ GND
- ④ Vos
- ⑤ S.S

Plastic Mold Package Type  
 Flammability: UL94V-0  
 Product Mass: Approx. 2.3g

Block Diagram

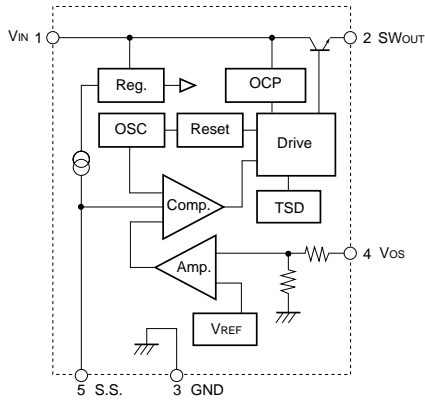

Typical Connection Diagram

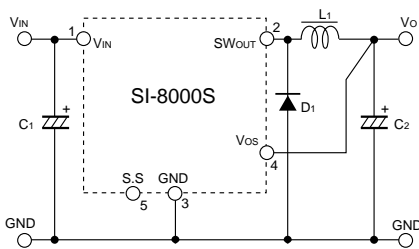

- C<sub>1,2</sub> : 1000μF
- L<sub>1</sub> : 150μH
- D<sub>1</sub> : RK46(Sanken)

T<sub>a</sub>-P<sub>d</sub> Characteristics

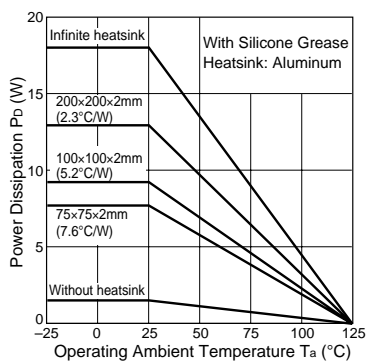

$$P_D = V_o \cdot I_o \left( \frac{100}{\eta \chi} - 1 \right) - V_F \cdot I_o \left( 1 - \frac{V_o}{V_{IN}} \right)$$

The efficiency depends on the input voltage and the output current. Therefore, obtain the value from the efficiency graph and substitute the percentage in the formula above.

- V<sub>o</sub> : Output voltage
- V<sub>IN</sub> : Input voltage
- I<sub>o</sub> : Output current
- ηχ : Efficiency (%)
- V<sub>F</sub> : Diode D<sub>1</sub> forward voltage  
0.5V(RK46)

Thermal design for D<sub>1</sub> must be considered separately.