

SI-3000C Series

5-Terminal, Multi-Function, Full-Mold, Low Dropout Voltage Dropper Type

■Features

- Compact full-mold package (equivalent to TO220)
- Output current: 1.5A
- Low dropout voltage: $V_{DIF} \leq 1V$ (at $I_o = 1.5A$)
- Variable output voltage (rise only)
May be used for remote sensing
- Output ON/OFF control terminal is compatible with LS-TTL.
(It may be directly driven by LS-TTL or standard CMOS logic.)
- Built-in foldback overcurrent (SI-3033C: Drooping type overcurrent),
overvoltage, thermal protection circuits

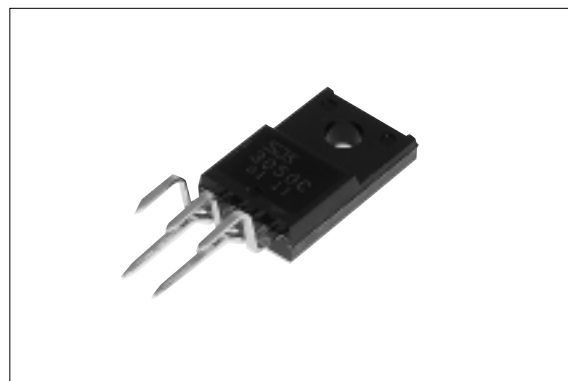

■Applications

- For stabilization of the secondary stage of switching power supplies
- Electronic equipment

■Absolute Maximum Ratings

(T_a=25°C)

Parameter	Symbol	Ratings				Unit
		SI-3033C	SI-3050C/3090C	SI-3120C/3150C	SI-3240C	
DC Input Voltage	V _{IN}	20	35	35	45	V
Voltage of Output Control Terminal	V _c	V _{IN}				V
DC Output Current	I _o	1.5 ²				A
Power Dissipation	P _{D1}	18(With infinite heatsink)				W
	P _{D2}	1.5(Without heatsink, stand-alone operation)				W
Junction Temperature	T _j	-40 to +125				°C
Ambient Operating Temperature	T _{op}	-30 to +100				°C
Storage Temperature	T _{stg}	-40 to +125				°C
Thermal Resistance (junction to case)	R _{th(j-c)}	5.5				°C/W
Thermal Resistance (junction to ambient air)	R _{th(j-a)}	66.7(Without heatsink, stand-alone operation)				°C/W

■Electrical Characteristics

(T_a=25°C unless otherwise specified)

Parameter	Symbol	Ratings									Unit
		SI-3033C			SI-3050C			SI-3090C			
		min.	typ.	max.	min.	typ.	max.	min.	typ.	max.	
Input Voltage	V _{IN}	*3		15 ²	6 ³		30 ²	10 ³		30 ²	V
Output Voltage	SI-3000C *1	3.168	3.300	3.432	4.80	5.00	5.20	8.64	9.00	9.36	V
	SI-3000CA	3.234	3.300	3.366	4.90	5.00	5.10	8.82	9.00	9.18	
Dropout Voltage	Conditions	V _{IN} =5V, I _o =1.0A			V _{IN} =8V, I _o =1.0A			V _{IN} =12V, I _o =1.0A			V
	V _{DIF}			0.5			0.5			0.5	
	Conditions	I _o ≤1.0A									
Line Regulation	Conditions			1.0			1.0			1.0	mV
	Conditions	I _o ≤1.5A									
Load Regulation	ΔV _{OLINE}		10	30		10	30		18	48	mV
	Conditions	V _{IN} =4.5 to 12V, I _o =1.0A			V _{IN} =6 to 15V, I _o =1.0A			V _{IN} =10 to 20V, I _o =1.0A			
Temperature Coefficient of Output Voltage	ΔV _{OLOAD}		40	100		40	100		70	180	mV
	Conditions	V _{IN} =5V, I _o =0 to 1.5A			V _{IN} =8V, I _o =0 to 1.5A			V _{IN} =12V, I _o =0 to 1.5A			
Ripple Rejection	ΔV _O /ΔT _a		±0.5			±0.5			±1.0		mV/°C
	Conditions	V _{IN} =5V, I _o =5mA, T _j =0 to 100°C			V _{IN} =8V, I _o =5mA, T _j =0 to 100°C			V _{IN} =12V, I _o =5mA, T _j =0 to 100°C			
Quiescent Circuit Current	R _{REJ}		54			54			54		dB
	Conditions	V _{IN} =5V, f=100 to 120Hz			V _{IN} =8V, f=100 to 120Hz			V _{IN} =12V, f=100 to 120Hz			
Overcurrent Protection Starting Current*4,6	I _q		3	10		5	10		5	10	mA
	Conditions	V _{IN} =5V, I _o =0A			V _{IN} =8V, I _o =0A			V _{IN} =12V, I _o =0A			
V _c Terminal*5	I _{s1}	1.6			1.6			1.6			A
	Conditions	V _{IN} =5V			V _{IN} =8V			V _{IN} =12V			
Control Voltage (Output ON)	V _c IH	2.0			2.0			2.0			V
	V _c IL			0.8			0.8			0.8	
	Control Current (Output ON)	I _c IH		20			20			20	μA
	Conditions	V _c =2.7V									
Control Current (Output OFF)	I _c IL			-0.3			-0.3			-0.3	mA
	Conditions	V _c =0.4V									

*1: "A" may be indicated to the right of the Sanken logo.

*2: V_{IN(max)} and I_{O(max)} are restricted by the relation P_{D(max)}=(V_{IN}-V_O)•I_O=18(W).

*3: Refer to the dropout voltage.(Refer to Setting DC Input Voltage on page 7.)

*4: I_{s1} is specified at -5(%) drop point of output voltage V_O on the condition that V_{IN}=V_O+3V, I_o=1A.

*5: Output is ON even when output control terminal V_c is open. Each input level is equivalent to LS-TTL. Therefore, it may be directly driven by an LS-TTL circuit.

*6: A foldback type overcurrent protection circuit is built into the I_c regulator (excluding SI-3033C). Therefore, avoid using it for the following applications as it may cause starting errors:

- (1) Constant current load (2) Plus/minus power (3) Series power (4) V_O adjustment by raising ground voltage

■Electrical Characteristics

(Ta=25°C unless otherwise specified)

Parameter	Symbol	Ratings									Unit
		SI-3120C			SI-3150C			SI-3240C			
		min.	typ.	max.	min.	typ.	max.	min.	typ.	max.	
Input Voltage	V _{IN}	13 ³		30 ²	16 ³		30 ²	25 ³		40 ²	V
Output Voltage	SI-3000C *1	11.52	12.00	12.48	14.40	15.00	15.60	23.04	24.00	24.96	V
	SI-3000CA	11.76	12.00	12.24	14.70	15.00	15.30	23.52	24.00	24.48	
Dropout Voltage	Conditions	V _{IN} =15V, I _O =1.0A			V _{IN} =18V, I _O =1.0A			V _{IN} =27V, I _O =1.0A			V
	V _{DIF}			0.5			0.5			0.5	
	Conditions	I _O ≤1.0A									
Line Regulation	ΔV _{OLINE}		24	64		30	90		48	128	mV
	Conditions	V _{IN} =13 to 25V, I _O =1.0A			V _{IN} =16 to 25V, I _O =1.0A			V _{IN} =25 to 38V, I _O =1.0A			
Load Regulation	ΔV _{OLOAD}		93	240		120	300		120	300	mV
	Conditions	V _{IN} =15V, I _O =0 to 1.5A			V _{IN} =18V, I _O =0 to 1.5A			V _{IN} =27V, I _O =0 to 1.5A			
Temperature Coefficient of Output Voltage	ΔV _O /ΔT _a		±1.5			±1.5			±2.5		mV/°C
	Conditions	V _{IN} =15V, I _O =5mA, T _J =0 to 100°C			V _{IN} =18V, I _O =5mA, T _J =0 to 100°C			V _{IN} =27V, I _O =5mA, T _J =0 to 100°C			
Ripple Rejection	R _{REJ}		54			54			54		dB
	Conditions	V _{IN} =15V, f=100 to 120Hz			V _{IN} =18V, f=100 to 120Hz			V _{IN} =27V, f=100 to 120Hz			
Quiescent Circuit Current	I _q		5	10		5	10		5	10	mA
	Conditions	V _{IN} =15V, I _O =0A			V _{IN} =18V, I _O =0A			V _{IN} =27V, I _O =0A			
Overcurrent Protection Starting Current*4,6	I _{S1}	1.6			1.6			1.6			A
	Conditions	V _{IN} =15V			V _{IN} =18V			V _{IN} =27V			
V _c Terminal ⁵	Control Voltage (Output ON)	V _c IH	2.0		2.0			2.0			V
	Control Voltage (Output OFF)	V _c IL			0.8		0.8			0.8	
	Control Current (Output ON)	I _c IH			20		20			20	μA
		Conditions	V _c =2.7V								
	Control Current (Output OFF)	I _c IL			-0.3		-0.3				-0.3
Conditions		V _c =0.4V									

*1: "A" may be indicated to the right of the Sanken logo.

*2: V_{IN(max)} and I_{O(max)} are restricted by the relation P_{D(max)}=(V_{IN}-V_O)•I_O=18(W).

*3: Refer to the dropout voltage.(Refer to Setting DC Input Voltage on page 7.)

*4: I_{S1} is specified at -5(%) drop point of output voltage V_O on the condition that V_{IN}=V_O+3V, I_O=1A.

*5: Output is ON even when output control terminal V_c is open. Each input level is equivalent to LS-TTL. Therefore, it may be directly driven by an LS-TTL circuit.

*6: A foldback type overcurrent protection circuit is built into the I_c regulator. Therefore, avoid using it for the following applications as it may cause starting errors:

- (1) Constant current load (2) Plus/minus power (3) Series power (4) V_O adjustment by raising ground voltage

■External Dimensions

(unit:mm)

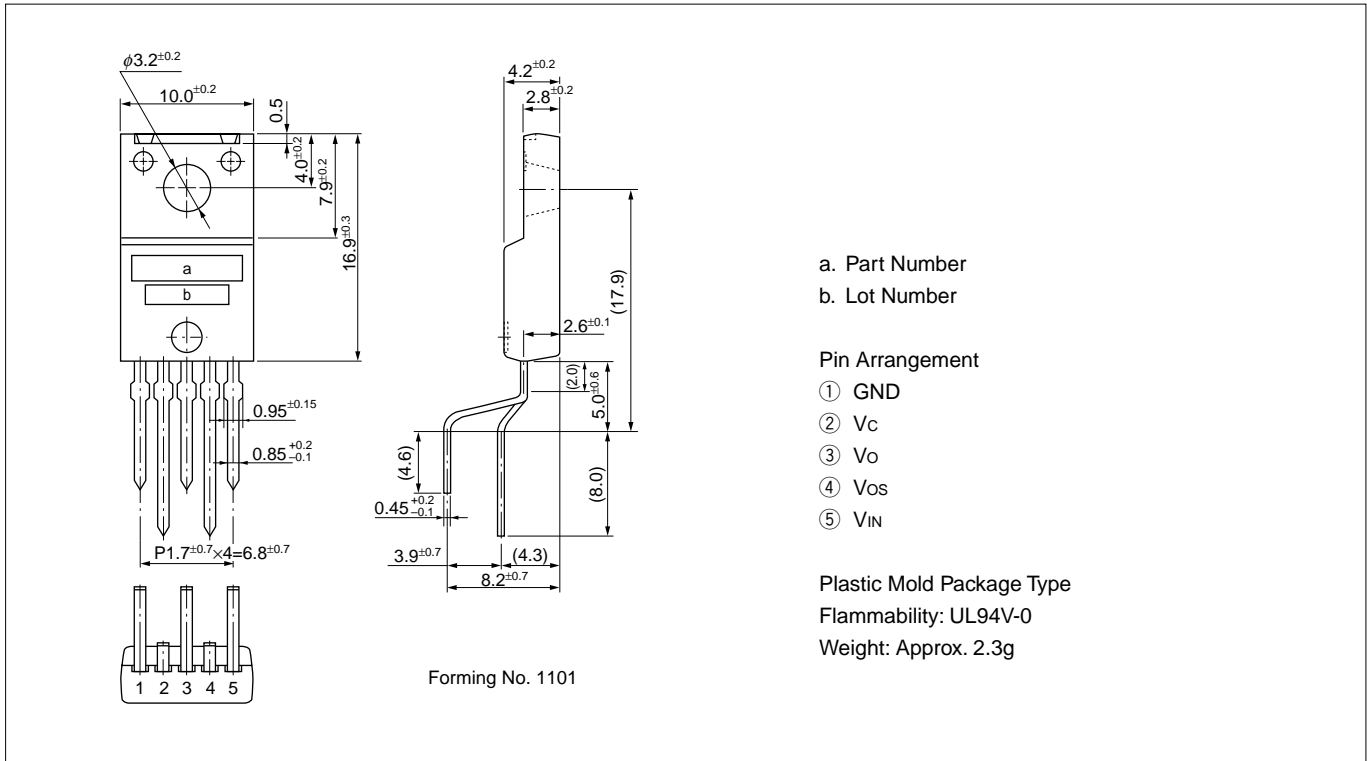

■Block Diagram

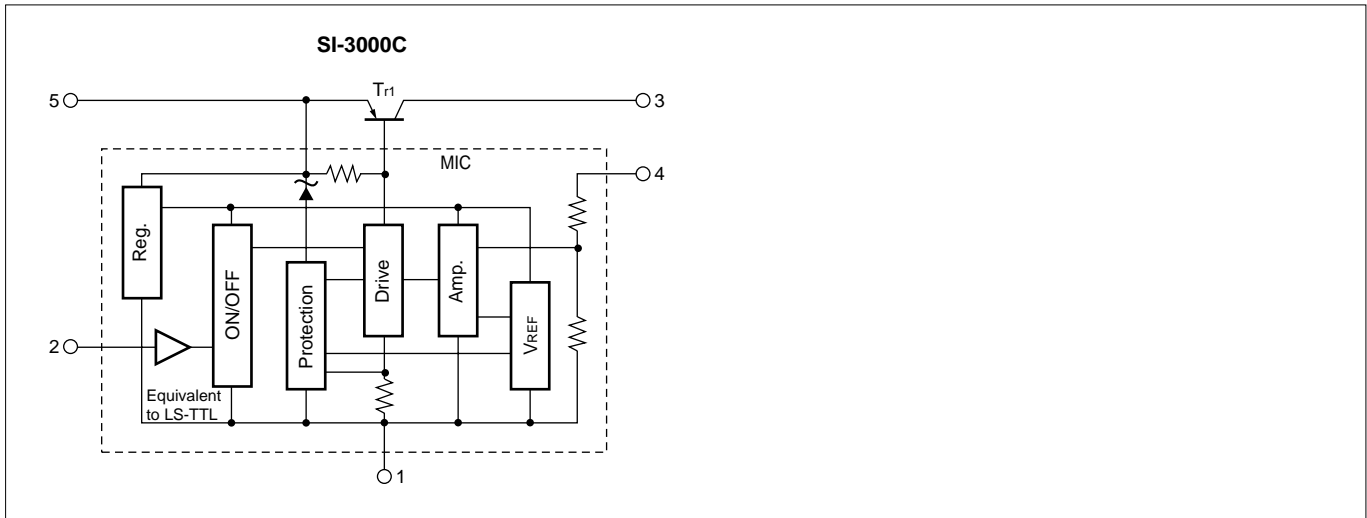

■Standard External Circuit

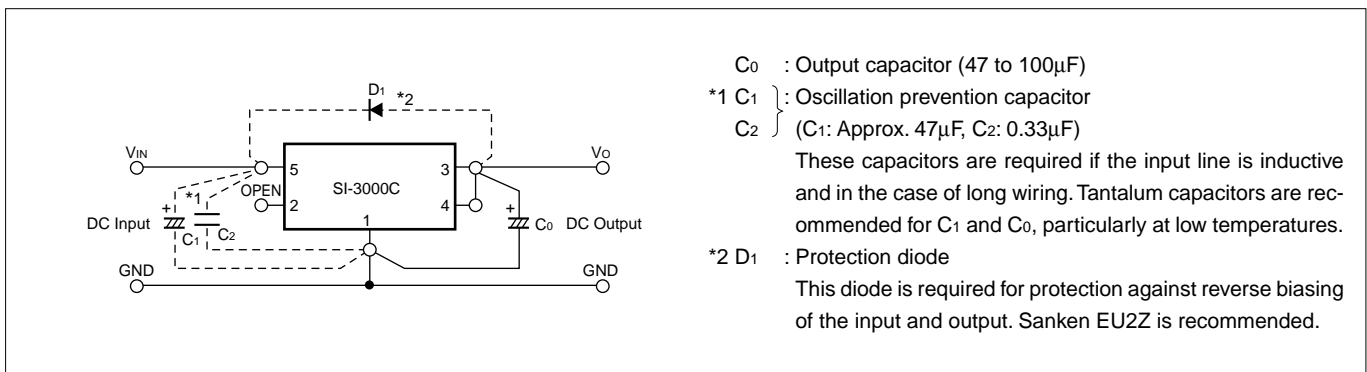

■ T_a - P_D Characteristics

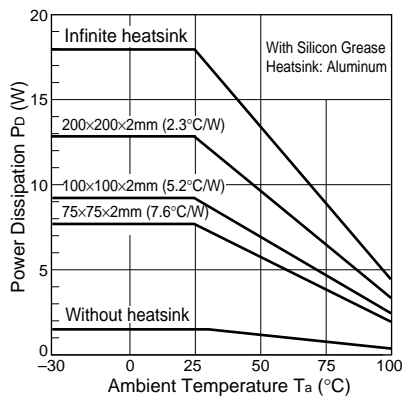

$$P_D = I_O \cdot [V_{IN(\text{mean})} - V_O]$$

External Variable Output Voltage Circuit

1. Variable output voltage with a single external resistor

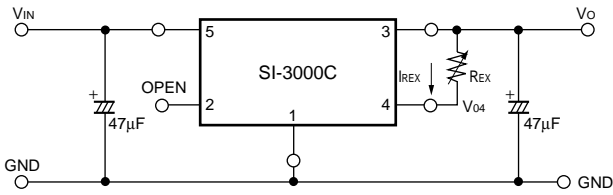

The output voltage may be increased by inserting resistor R_{EX} between terminals No.4 (sensing terminal) and No.3 (output terminal). The current I_{REX} flowing into terminal No.4 is 1mA (typ.)(SI-3033C:0.43mA (typ.)), therefore the adjusted output voltage V_{OUT} is:

$$V_O = V_{04} + I_{REX} \cdot R_{EX} \quad *V_{04}: \text{output voltage of SI-3000C series}$$

However, the internal resistor (between terminals No. 4 and No.1) is a semiconductor resistor, which has approximately thermal characteristics of +0.2%/°C.

It is important to keep the thermal characteristics in mind when adjusting the output voltage.

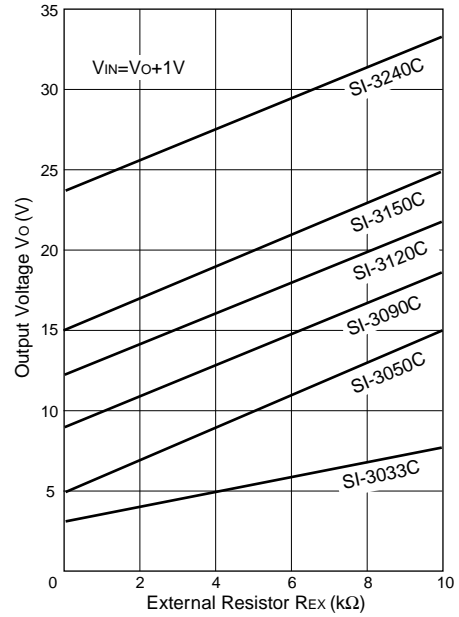

2. Variable output voltage with two external resistors

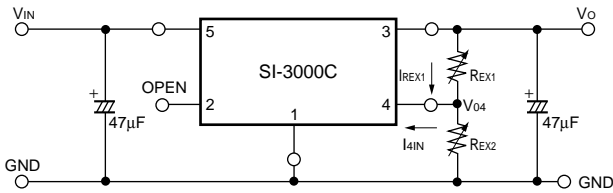

The output voltage may be increased by inserting resistors R_{EX1} between terminals No.4 (sensing terminal) and No.3 (output terminal) and R_{EX2} between terminals No.4 and No.1 (ground terminal).

The current I_{4IN} flowing into terminal No.4 is 1mA (typ.)(SI-3033C: 0.43mA (typ.)) so the thermal characteristics may be improved compared to the method shown in 1 by setting the external current I_{REX1} at approximately 5 times the value of I_{4IN} (stability coefficient $S=5$).

The adjusted output voltage V_{OUT} in this case is:

$$\begin{cases} V_O = V_{04} + R_{EX1} \cdot I_{REX1} \\ I_{REX1} = S \cdot I_{4IN} \end{cases}$$

The value of the external resistors may be obtained as follows:

$$R_{EX1} = \frac{V_O - V_{04}}{S \cdot I_{4IN}}, \quad R_{EX2} = \frac{V_{04}}{(S-1) \cdot I_{4IN}}$$

* V_{04} : Output voltage of SI-3000C series

S: Stability coefficient of I_{4IN} (may be set to any value)

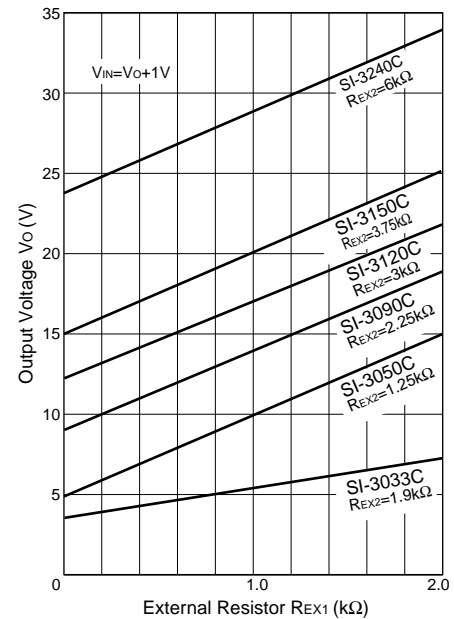

Note: In the SI-3000C series, the output voltage increase can be adjusted as mentioned above. However, when the rise is set to approximately 10V compared to output voltage V_{04} , the necessary output current may not be obtained due to the S.O.A. protection circuit in the SI-3000C series.

■Typical Characteristics

($T_a=25^\circ\text{C}$)

Io vs. VDIF Characteristics

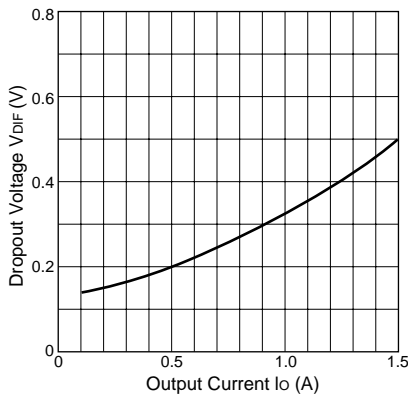

Temperature Coefficient of Output Voltage(SI-3050C)

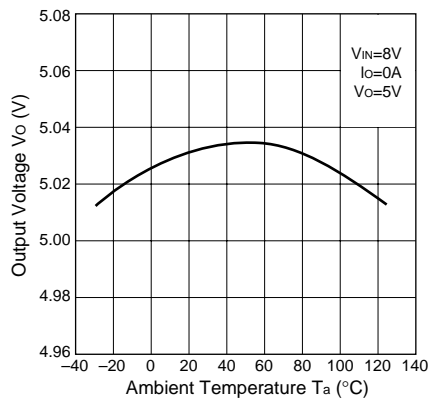

Circuit Current(SI-3050C)

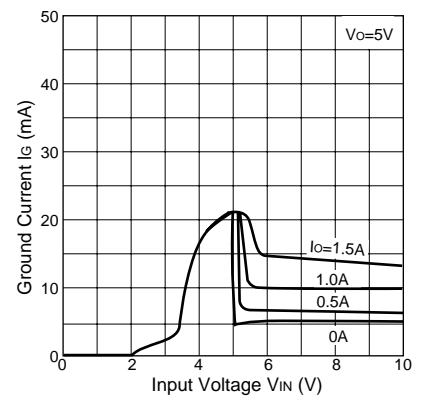

Output Voltage(SI-3033C)

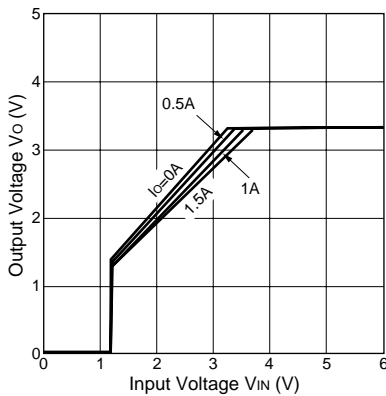

Output Voltage(SI-3050C)

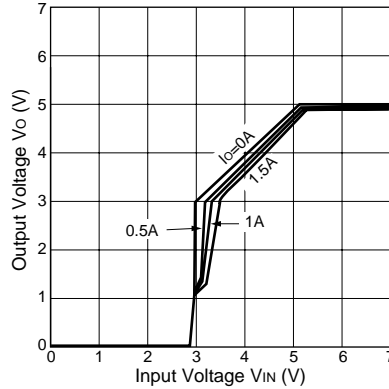

Output Voltage(SI-3240C)

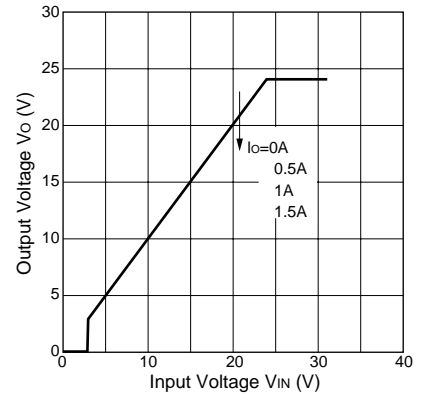

Overcurrent Protection Characteristics(SI-3033C)

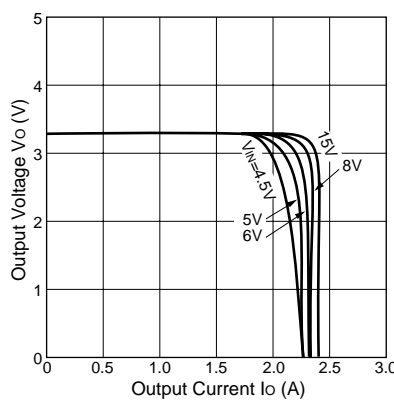

Overcurrent Protection Characteristics(SI-3050C)

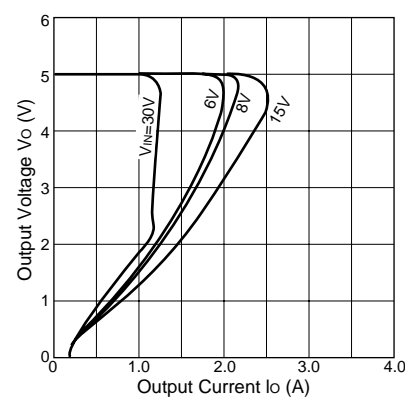

Overcurrent Protection Characteristics(SI-3240C)

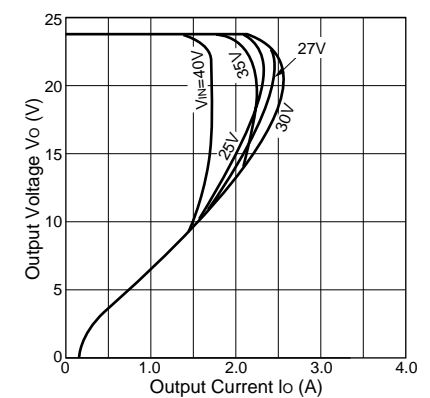

ON/OFF Control Characteristics(SI-3050C)

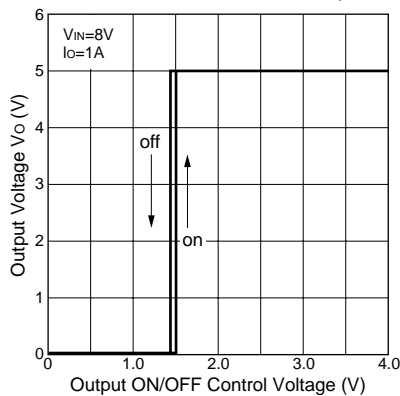

Thermal Protection Characteristics(SI-3050C)

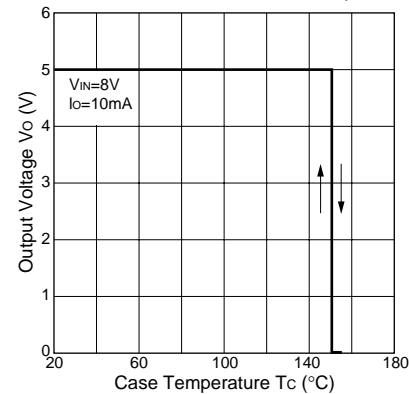

Note on Thermal Protection:

The thermal protection circuit is intended for protection against heat during instantaneous short-circuiting. Its operation is not guaranteed for continuous heating condition such as short-circuiting over extended periods of time.