

Features

- Colorless transparency lens type
- $\phi 5\text{mm}$ (T-13/4) all plastic mold type
- Low power consumption
- High radiant intensity

Applications

- Infrared remote control and free air transmission systems with low forward voltage and comfortable radiation angle requirements in combination with PIN photodiodes or phototransistors.

Outline Dimensions

unit : mm

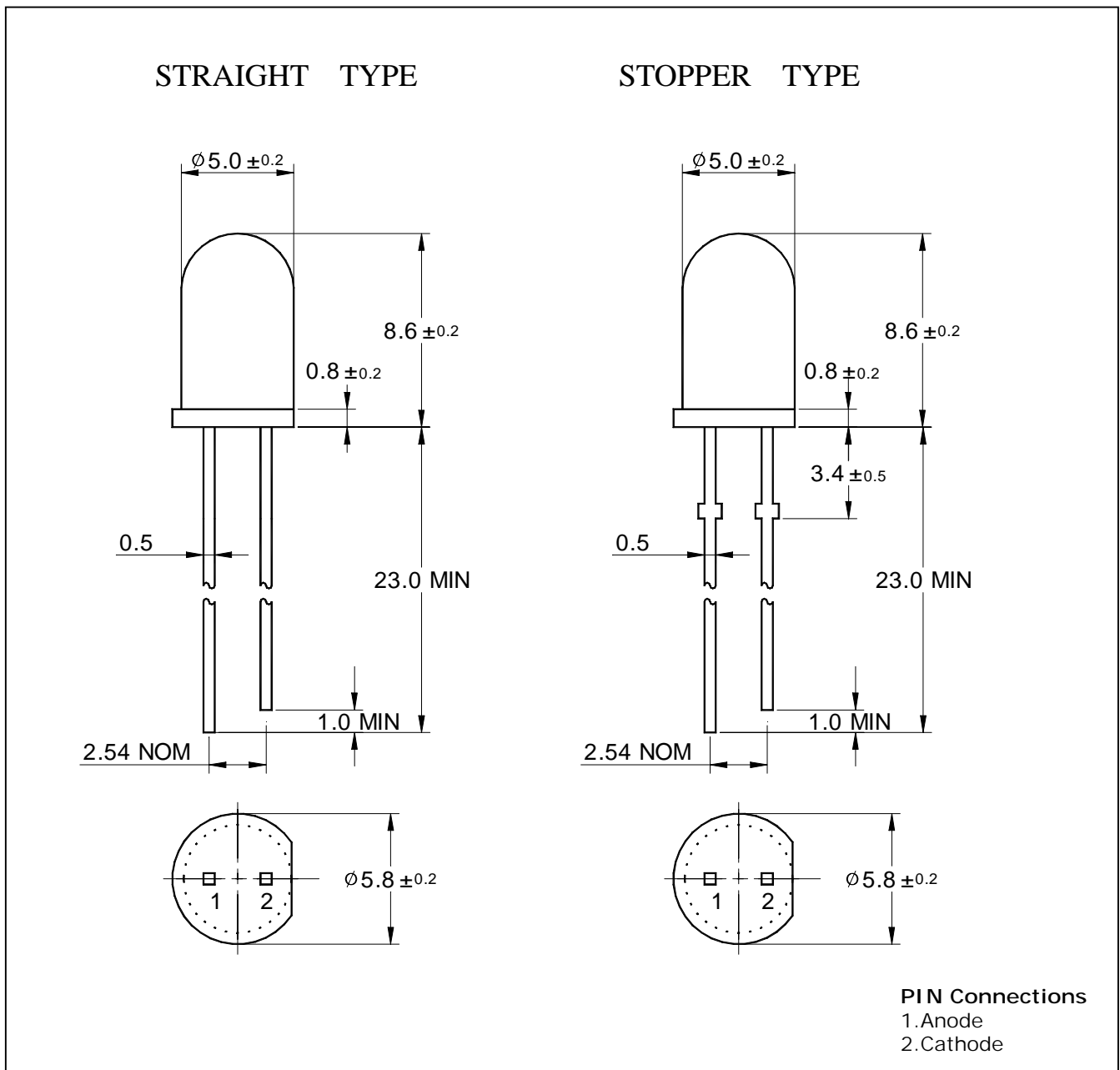

Absolute maximum ratings

Characteristic	Symbol	Ratings	Unit
Power Dissipation	P_D	150	mW
Forward Current	I_F	100	mA
* ¹ Peak Forward Current	I_{FP}	1	A
Reverse Voltage	V_R	4	V
Operating Temperature	T_{opr}	-25 85	
Storage Temperature	T_{stg}	-30 100	
* ² Soldering Temperature	T_{sol}	260 for 5 seconds	

*1. Duty ratio = 1/16, Pulse width = 0.1ms

*2. Keep the distance more than 2.0mm from PCB to the bottom of IRED package

Electrical Characteristics

Characteristic	Symbol	Test Condition	Min.	Typ.	Max.	Unit
Forward Voltage	V_F	$I_F = 50\text{mA}$	-	1.3	1.7	V
Radiant Intensity	I_E	$I_F = 50\text{mA}$	20	40	-	mW/Sr
Peak Wavelength	λ_P	$I_F = 50\text{mA}$	-	950	-	nm
Spectrum Bandwidth		$I_F = 50\text{mA}$	-	50	-	nm
Reverse Current	I_R	$V_R = 4\text{V}$	-	-	10	μA
* ³ Half angle	$\theta^{1/2}$	$I_F = 50\text{mA}$	-	± 20	-	deg

*3. $\theta^{1/2}$ is the off-axis angle where the luminous intensity is 1/2 the peak intensity

Characteristic Diagrams

Fig. 1 $I_F - V_F$

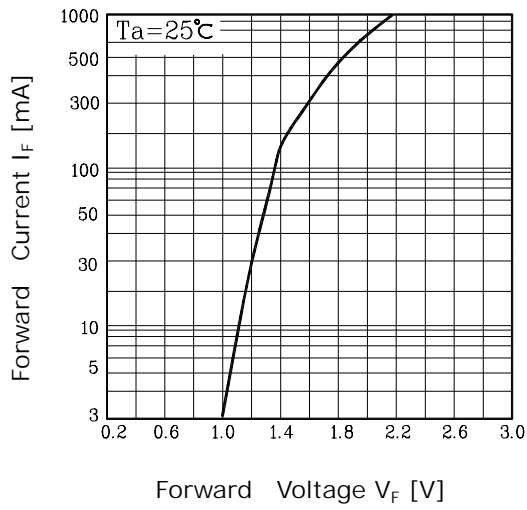

Fig. 2 $I_E - I_F$

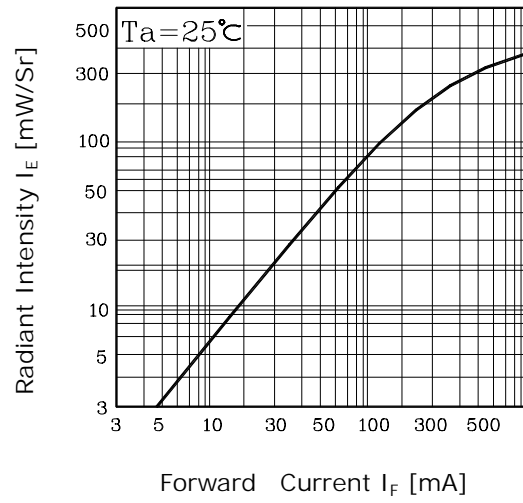

Fig. 3 $I_F - T_a$

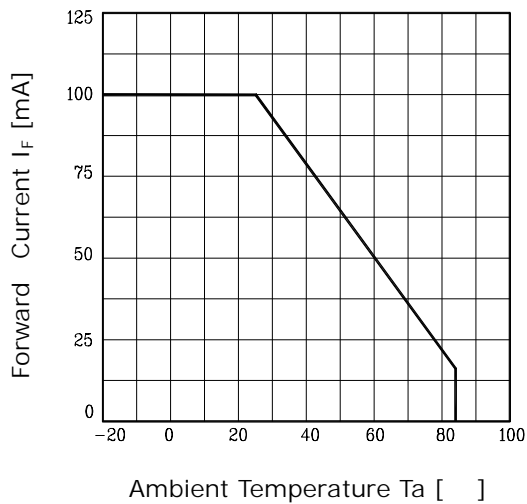

Fig. 4 Spectrum Distribution

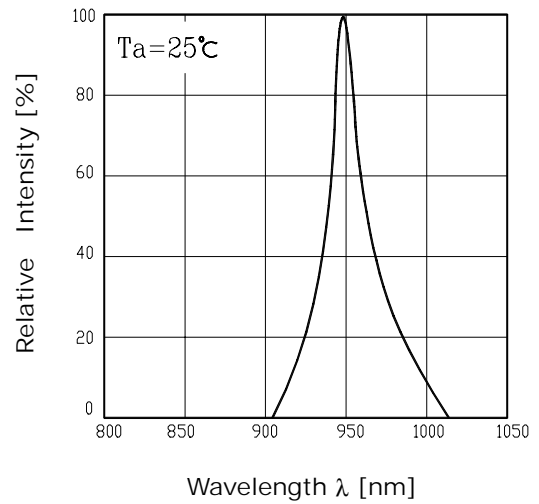

Fig. 5 Radiation Diagram

