

Dual N-Channel 2.5-V (G-S) MOSFET

2.5-V Rated

PRODUCT SUMMARY		
V _{DS} (V)	r _{DS(on)} (Ω)	I _D (A)
20	0.05 @ V _{GS} = 4.5 V	5.0
	0.06 @ V _{GS} = 3.0 V	4.2
	0.08 @ V _{GS} = 2.5 V	3.6

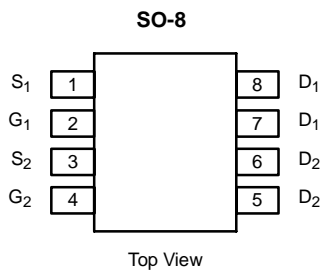

Ordering Information: Si9925DY
 Si9925DY-T1 (with Tape and Reel)

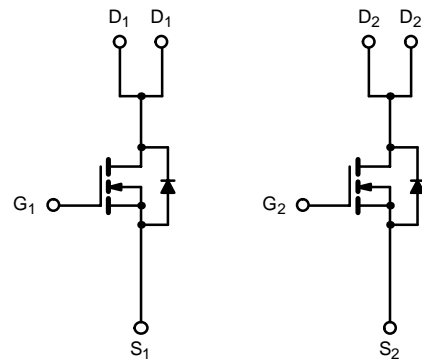

N-Channel MOSFET

N-Channel MOSFET

ABSOLUTE MAXIMUM RATINGS (T _A = 25 °C UNLESS OTHERWISE NOTED)				
Parameter		Symbol	Limit	Unit
Drain-Source Voltage		V _{DS}	20	V
Gate-Source Voltage		V _{GS}	± 12	
Continuous Drain Current (T _J = 150 °C) ^a	T _A = 25 °C	I _D	5.0	A
	T _A = 70 °C		4.0	
Pulsed Drain Current		I _{DM}	48	
Continuous Source Current (Diode Conduction) ^a		I _S	1.7	
Maximum Power Dissipation ^a	T _A = 25 °C	P _D	2	W
	T _A = 70 °C		1.3	
Operating Junction and Storage Temperature Range		T _J , T _{stg}	-55 to 150	°C

THERMAL RESISTANCE RATINGS				
Parameter		Symbol	Limit	Unit
Maximum Junction-to-Ambient ^a		R _{thJA}	62.5	°C/W

Notes

a. Surface Mounted on FR4 Board, t ≤ 10 sec.

For SPICE model information via the Worldwide Web: <http://www.vishay.com/www/product/spice.htm>

Specifications (T _J = 25°C Unless Otherwise Noted)						
Parameter	Symbol	Test Condition	Min	Typ ^a	Max	Unit
Static						
Gate Threshold Voltage	V _{GS(th)}	V _{DS} = V _{GS} , I _D = 250 μA	0.8			V
Gate-Body Leakage	I _{GSS}	V _{DS} = 0 V, V _{GS} = ±12 V			± 100	nA
Zero Gate Voltage Drain Current	I _{DSS}	V _{DS} = 10 V, V _{GS} = 0 V			1	μA
		V _{DS} = 16 V, V _{GS} = 0 V, T _J = 70°C			5	
On-State Drain Current ^b	I _{D(on)}	V _{DS} ≥ 5 V, V _{GS} = 5 V	30			A
Drain-Source On-State Resistance ^b	r _{DS(on)}	V _{GS} = 7.2 V, I _D = 5.0 A	0.025	0.038	0.045	Ω
		V _{GS} = 4.5 V, I _D = 5.0 A		0.041	0.05	
		V _{GS} = 3.0 V, I _D = 3.9 A		0.050	0.06	
		V _{GS} = 2.5 V, I _D = 1 A		0.062	0.08	
Forward Transconductance ^b	g _{fs}	V _{DS} = 10 V, I _D = 5.0 A		14		S
Diode Forward Voltage ^b	V _{SD}	I _S = 5.0 A, V _{GS} = 0 V		0.81	1.2	V
Dynamic^a						
Total Gate Charge	Q _g	V _{DS} = 6 V, V _{GS} = 4.5 V, I _D = 5.0 A		9	20	nC
Gate-Source Charge	Q _{gs}			2		
Gate-Drain Charge	Q _{gd}			2.6		
Gate Resistance	R _g		1		2.9	Ω
Turn-On Delay Time	t _{d(on)}	V _{DD} = 6 V, R _L = 6 Ω I _D ≅ 1 A, V _{GEN} = 4.5 V, R _G = 6 Ω		14	40	ns
Rise Time	t _r			13	30	
Turn-Off Delay Time	t _{d(off)}			35	60	
Fall Time	t _f			9	30	
Source-Drain Reverse Recovery Time	t _{rr}	I _F = 5.0 A, di/dt = 100 A/μs		60	150	

Notes

- a. Guaranteed by design, not subject to production testing.
b. Pulse test; pulse width ≤ 300 μs, duty cycle ≤ 2%.



TYPICAL CHARACTERISTICS (25°C UNLESS NOTED)

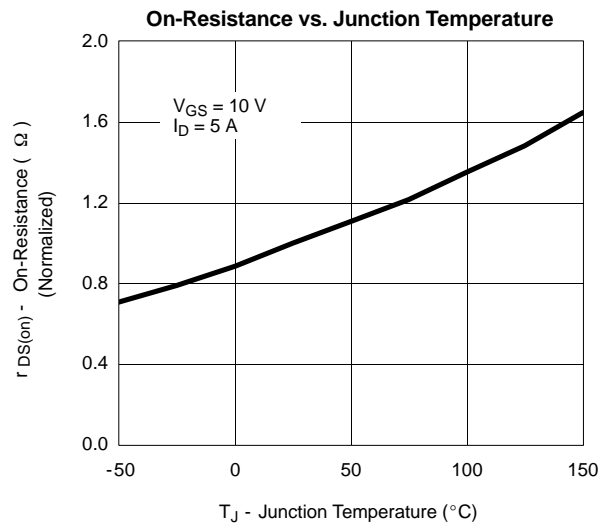
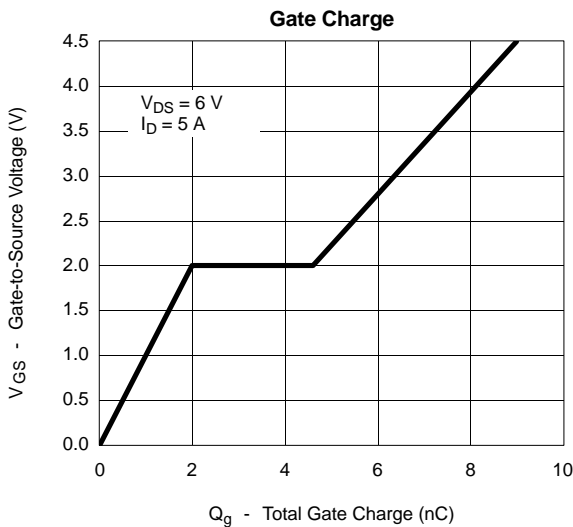
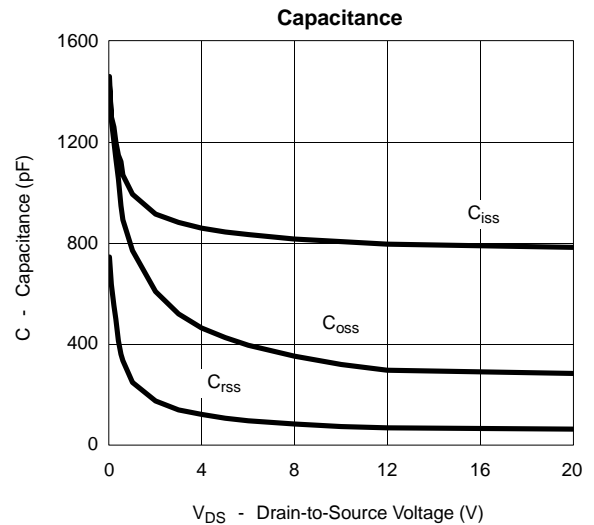
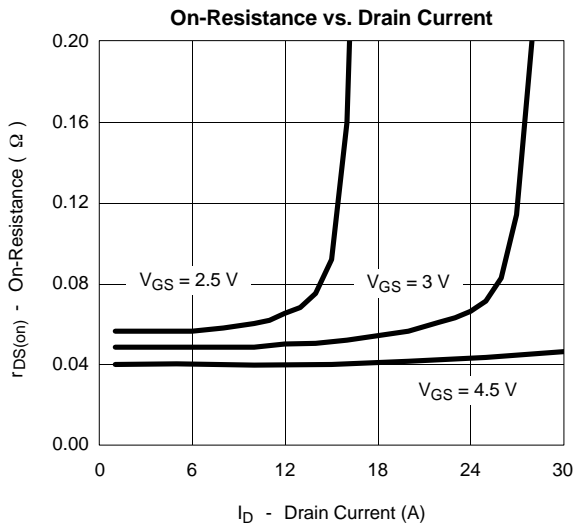
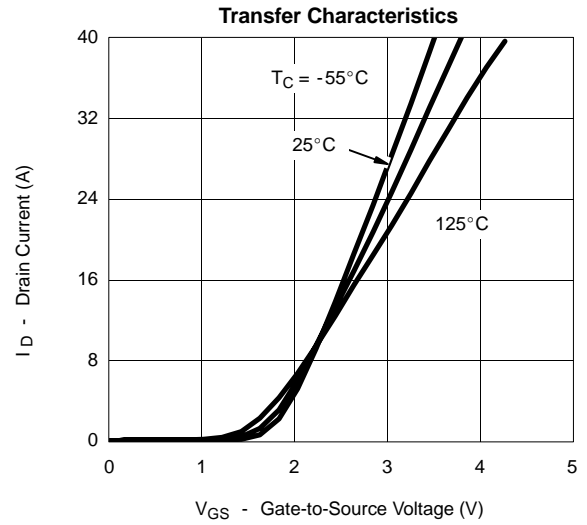
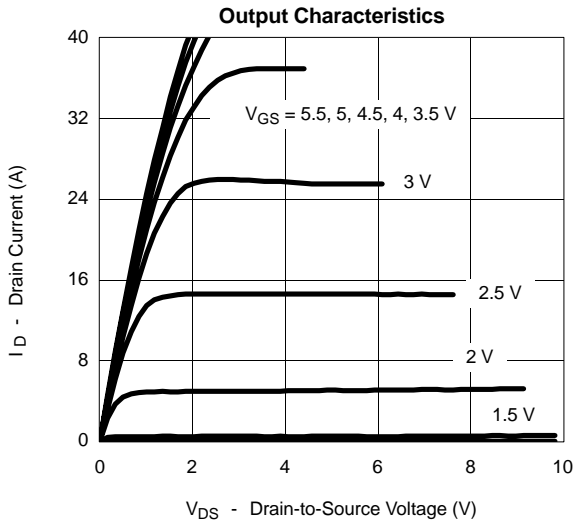

TYPICAL CHARACTERISTICS (25 °C UNLESS NOTED)

