



Features

- Small size (20.6x10.2x15.7mm) with 5A/10A switching capability for high density PCB mounting.
- Surge voltage : 8000V (1.2/50us).
- Apply to air conditioner, refrigerator, microwave oven, stove etc.

Safety Approval

UL , C-UL File No. : E190598

TUV File No. : R50143457

CQC File No. : CQC04001009429

VDE File No.: 40035912

Contact Capacity

Model	SJE -D(E,L)	SJE -D(E,L)H	SJE -D(E,L)M	SJE-D(E,L)MH
Nominal switching capacity	NO/NC : 5A/3A 277VAC	NO/NC : 10A/5A 277VAC	5A 277VAC TV-3 120VAC	10A 277VAC TV-5 120VAC
Max. switching current	5A	10A	5A	10A
Max. switching voltage	277VAC	277VAC	277VAC	277VAC
Max. switching power	1,385VA	2,770VA	1,385VA	2,770VA

Characteristic Data

Contact material	Silver alloy	
Initial contact resistance (at 6VDC/1A)	100mΩ Max.	
Operate time (at nominal volt.)	10msec. Max.	
Release time (at nominal volt.)	4msec. Max.	
Initial insulation resistance	100MΩ Min.(DC500V)	
Initial dielectric strength	Between open contacts : AC1,000V , 50/60Hz 1Min.	
	Between coil and contact : AC4,000V(Form A),AC3,500V(Form C),50/60Hz 1Min	
Vibration resistance	Functional	10 ~ 55Hz at double amplitude of 1.5 mm
	Destructive	10 ~ 55Hz at double amplitude of 1.5 mm
Shock resistance	Functional	10G Min.
	Destructive	100G Min.
Endurance (operations)	Mechanical (at 10,800 ops./h)	10,000,000
	Electrical (at 1,800 ops./h)	100,000
Ambient temperature	-40°C ~ +105°C (no condensation)	
Unit weight	Approx. 6.5 g	

Coil Data (at 20°C)

Nominal voltage (VDC)	Nominal operating current 10% (mA)	Coil resistance 10% (Ω)	Max. allowable voltage	Pick-up voltage (Max.)	Drop-out voltage (Min.)	Nominal operating power
3	150.00	20	130 % of nominal voltage	75 % of nominal voltage	5 % of nominal voltage	0.45W
5	90.00	55				
6	75.00	80				
9	50.00	180				
12	37.50	320				
18	25.00	720				
24	18.75	1,280				
48	9.38	5,120				

Coil Data (at 20°C)

Nominal voltage (VDC)	Nominal operating current 10% (mA)	Coil resistance 10% (Ω)	Max. allowable voltage	Pick-up voltage (Max.)	Drop-out voltage (Min.)	Nominal operating power
3	133.33	22.5	130 % of nominal voltage	75 % of nominal voltage	5 % of nominal voltage	0.40W
5	80.00	62.5				
6	66.67	90				
9	44.44	202.5				
12	33.33	360				
18	22.22	810				
24	16.67	1440				
48	8.33	5760				
3	66.67	45	130 % of nominal voltage	75 % of nominal voltage (80 % for Form C)	5 % of nominal voltage	0.20W
5	40.00	125				
6	33.33	180				
9	22.22	405				
12	16.67	720				
18	11.11	1,620				
24	8.33	2,880				
48	4.17	11,520				

Safety Approval Ratings

Approval	CQC	TUV	VDE	UL/CUL
File No.	CQC04001009429	R50143457	40035912	E190598
Approved ratings	10A 277VAC 5A 277VAC 8A 250VAC(NO) 5A 250VAC(NC)	NO : 5A 250VAC NC : 3A 250VAC	From A: 10A 277VAC 5A 277VAC From C: 5A 277VAC, NO 3A 277VAC, NC 10A 277VAC, NO 5A 277VAC, NC	SJE - D : Form A : 10A 125VAC , Resistive 5A 250VAC/30VDC , Resistive 1.5A 250VAC , General use 5A 277VAC , Resistive&General use 8A 250VAC, Resistive&General use TV-3 120VAC 1/6HP 277VAC Form C : 5A 250VAC/30VDC , Resistive , NO 3A 250VAC/30VDC , Resistive , NC 1A 250VAC , General Use, NO/NC 5A 277VAC , Resistive&General Use , NO 8A 250VAC, Resistive&General Use , NO 10A 277VAC , Resistive/General Use , NO 5A 277VAC , Resistive/General Use , NC 1/6HP 277VAC , N.O. TV-3 120VAC, N.O. SJE - L : Form A : 3A 250VAC/30VDC , Resistive 1.5A 250VAC , General use 5A 277VAC , Resistive 10A 277VAC , Resistive&General Use 1/6HP 277VAC Form C : 3A 250VAC , Resistive, NO/NC 3A 30VDC , Resistive, NO/NC 1A 250VAC , General Use, NO/NC 5A 277VAC , Resistive , N.O. 1/6HP 277VAC , N.O. 10A 277VAC , Resistive&General Use , NO 3A 277VAC , Resistive&General Use , NC SJE - E : Form A : 5A 277VAC , Resistive&General Use 10A 277VAC , Resistive&General Use TV-5 120VAC Form C : 3A/5A 277VAC , Resistive&General Use 5A/10A 277VAC , Resistive&General Use

Ordering Information

Nomenclature										
SJE	-S	-1	12	D	M	H	1	-F	-XX	Special Parameter : Nil-Standard type, Letter or number-Special requirement
Insulation System : Nil-Standard, B-Class B, F-Class F										
Contact Material : Nil-AgSnO ₂ , 1-AgCdO, 2-AgNi										
Load Capacity : Nil-Standard, H-10A										
Contact Form : Nil-Form C, B-Form B, M-Form A										
Coil Power : D-0.45W, E-0.40W, L-0.20W										
Coil Voltage (VDC) : 03, 05, 06, 09, 12, 18, 24, 48										
Number of Poles : 1-1 Pole										
Protective Construction : S-Flux proofed, SH-Sealed type washable										
Type Designation : SJE										

Outline Dimensions, Wiring Diagram, P.C. Board Layout (unit : mm)

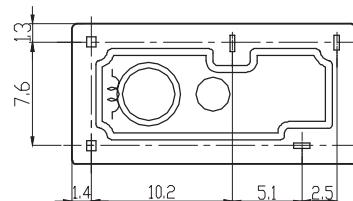
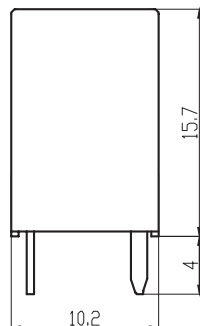
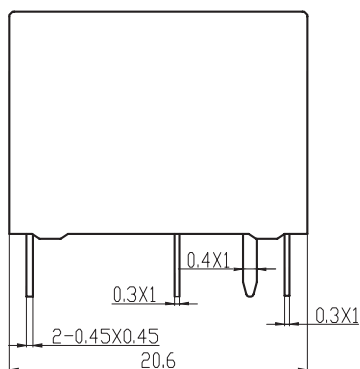

bottom view

Unless otherwise specified :
 If dimension < 1mm, tolerance : 0.2 mm;
 If dimension 1~5mm, tolerance : 0.3 mm;
 If dimension > 5mm, tolerance : 0.4 mm.
 Note : 1. Extended terminal dimension is dimension before soldering.
 2. Tolerance of P.C.B. layout : 0.1 mm.

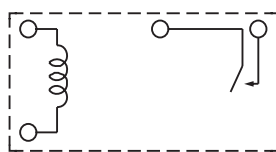
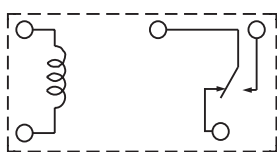

Wiring Diagram (bottom view)

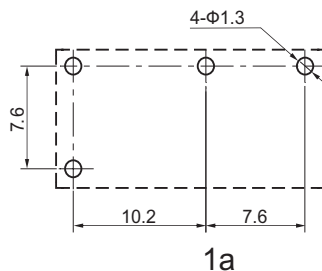
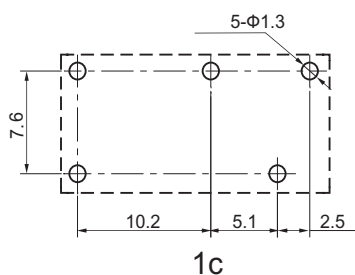

P.C.B. Layout (bottom view)

Typical Applications

Home appliances, office equipment, audio equipment, car, air conditioner, etc.

Characteristic Curves

Max. Switching Power

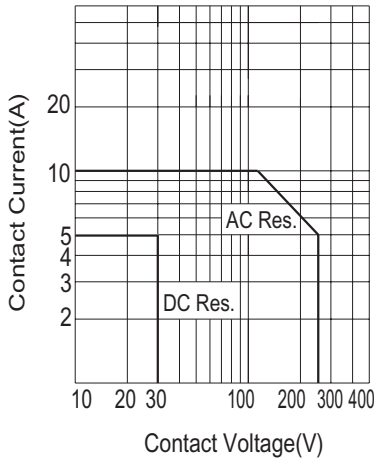

Endurance Curve

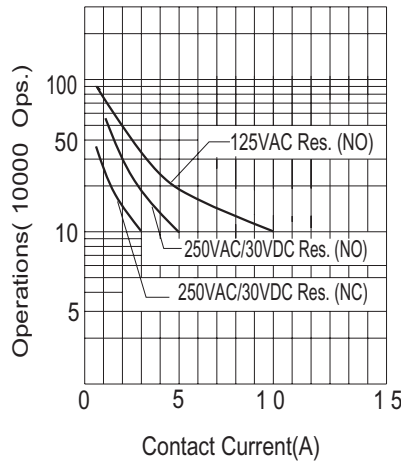

Coil Temp. Rise

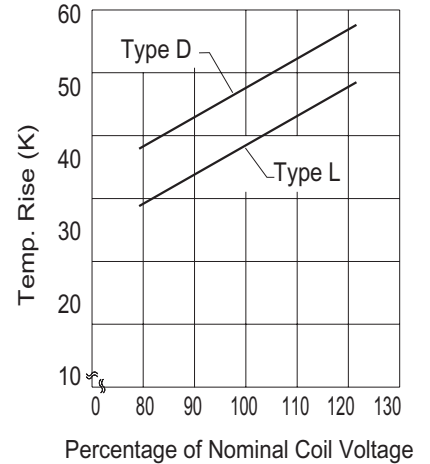

Disclaimer:

This datasheet is the customers' reference. All the specification are subject to change without notice.

We could not evaluate all the performance and all the parameters for every possible application. Thus the user should in a right position to choose the suitable product for their own application. If there is any query, please contact Sanyou for the technical service. However it is the user's responsibility to determine which product should be used only.

Dongguan Sanyou Electrical appliance Co.,LTD, All rights of Sanyou to reserved