

1 AMP SCHOTTKY BARRIER RECTIFIERS

FEATURES

- Metal semiconductor junction with guard ring
- Epitaxial Construction
- Low forward voltage drop
- High current capacity
- For use in low voltage, high frequency inverters, free wheeling, and polarity protection applications

MECHANICAL DATA

- Case: JEDEC DO-41, molded plastic (U/L Flammability Rating 94V-0)
- Terminals: Plated axial leads
- Soldering: Per MIL-STD 202 Method 208 guaranteed
- Polarity: Color band denotes cathode
- Mounting Position: Any
- Weight: 0.012 Ounces (0.34 Grams)

MECHANICAL SPECIFICATION

ACTUAL SIZE OF
DO-41 PACKAGE

SERIES SK102 - SK110

DO - 41

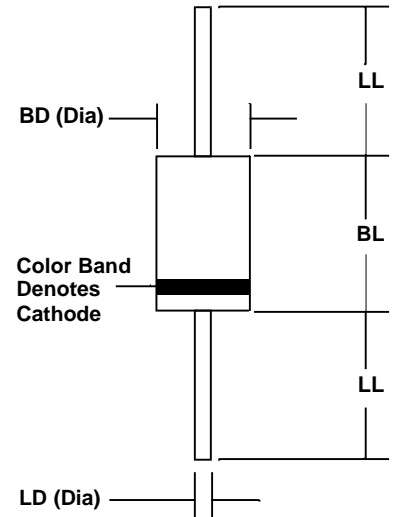

Sym	Minimum		Maximum	
	In	mm	In	mm
BL	0.160	4.1	0.205	5.2
BD	0.103	2.6	0.107	2.7
LL	1.00	25.4		
LD	0.028	0.71	0.034	0.86

MAXIMUM RATINGS & ELECTRICAL CHARACTERISTICS

Ratings at 25 °C ambient temperature unless otherwise specified.
 Single phase, half wave, 60Hz, resistive or inductive load.
 For capacitive loads, derate current by 20%.

PARAMETER (TEST CONDITIONS)	SYMBOL	RATINGS						UNITS
		SK102	SK104	SK106	SK107	SK108	SK110	
Series Number								
Maximum DC Blocking Voltage	VRM	20	40	60	70	80	100	VOLTS
Maximum RMS Voltage	VRMS	14	28	42	49	56	70	
Maximum Peak Recurrent Reverse Voltage	VRRM	20	40	60	70	80	100	
Average Forward Rectified Current @ TL = 90 °C (TL measured on cathode lead, 1/32 in. from case)	Io	1						AMPS
Peak Forward Surge Current (8.3mS single half sine wave superimposed on rated load)	IFSM	40						
Maximum Forward Voltage at 1 Amp DC	VFM	0.5		0.7		0.8		VOLTS
Maximum Average DC Reverse Current At Rated DC Blocking Voltage (Note 1)	IRM	0.5			0.1			mA
		10			5			
Typical Thermal Resistance, Junction to Ambient	RθJA	15						°C/W
Typical Junction Capacitance (Note 2)	CJ	110						pF
Junction Operating Temperature Range	TJ	-65 to +125				-65 to +150		°C
Storage Temperature Range	TSTG	-65 to +150						

NOTES: (1) Lead temperature reference is cathode lead 1/32 in from case.
 (2) Measured at 1MHz & applied reverse voltage of 4 volts

4394dat102

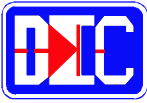

1 AMP SCHOTTKY BARRIER RECTIFIERS

RATING & CHARACTERISTIC CURVES FOR SERIES SK102 - SK107 and SERIES SK108 - SK110

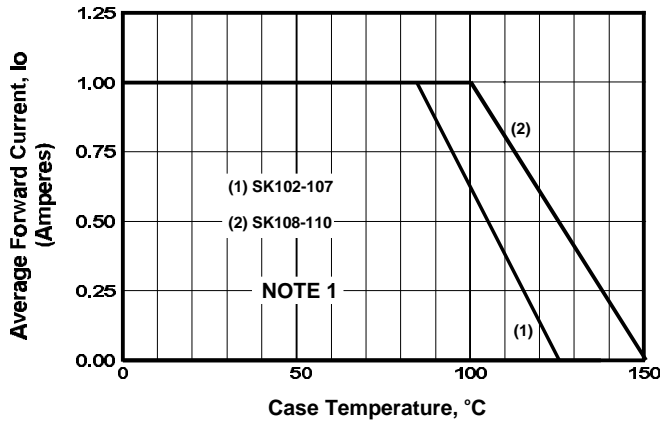

FIGURE 1. FORWARD CURRENT DERATING CURVE

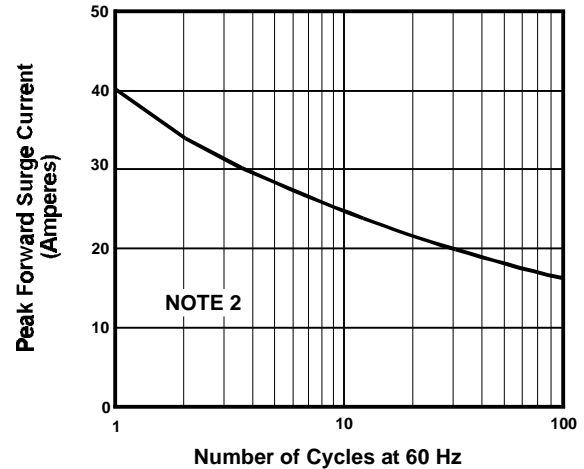

FIGURE 2. MAXIMUM NON-REPETITIVE SURGE CURRENT

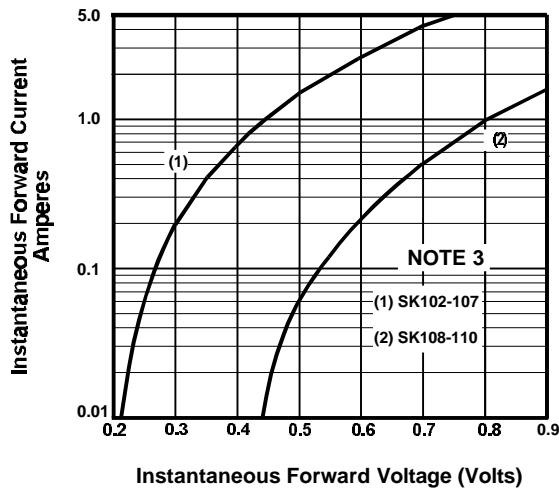

FIGURE 3. TYPICAL FORWARD CHARACTERISTICS

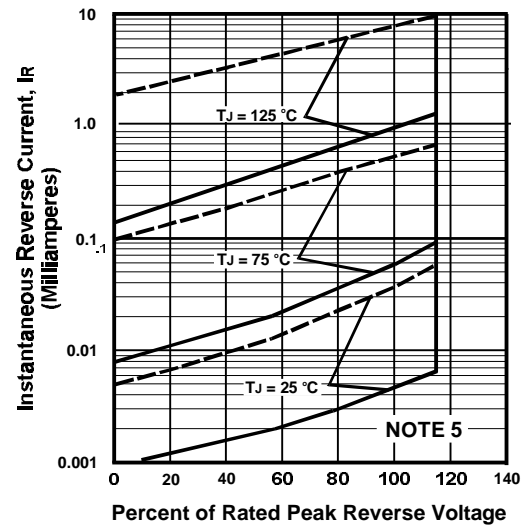

FIGURE 4. TYPICAL REVERSE CHARACTERISTICS

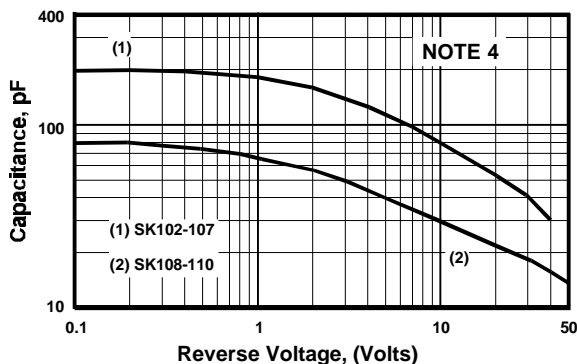

FIGURE 5. TYPICAL JUNCTION CAPACITANCE

NOTES

- (1) Single Phase, Half Wave, 60 Hz, Resistive or Inductive Load, 0.375" (9mm) Lead Length
- (2) JEDEC Method, 8.3 mSec. Single Half Sine Wave, $T_c = 95^\circ\text{C}$
- (3) $T_J = 25^\circ\text{C}$, Pulse Width = 300 μSec , 2.0% Duty Cycle
- (4) $T_J = 25^\circ\text{C}$, $f = 1\text{MHz}$, $V_{\text{SIG}} = 50\text{ mV P-P}$
- (5) Legend for Figure 4, Typical Reverse Characteristics:

----- SK102-107
 _____ SK108-110