

### SEMITOP® 3 IGBT Module

### SK 13 BGB 123 F

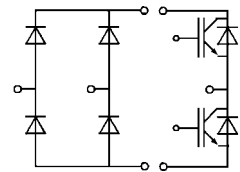
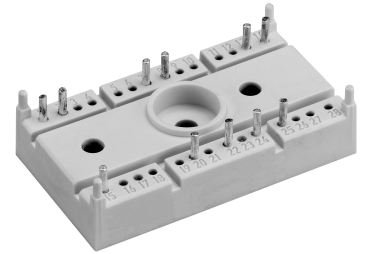

BGB

Absolute Maximum Ratings		Values	Units
Symbol	Conditions <sup>1)</sup>		
IGBT			
V <sub>CES</sub>		1200	V
V <sub>GES</sub>		± 20	V
I <sub>C</sub>	T <sub>h</sub> = 25/80 °C	33 / 22	A
I <sub>CM</sub>	t <sub>p</sub> < 1 ms; T <sub>h</sub> = 25/80 °C	66 / 44	A
I <sub>F</sub> = -I <sub>C</sub>	T <sub>h</sub> = 25/80 °C	18 / 12	A
I <sub>FM</sub> = -I <sub>CM</sub>	t <sub>p</sub> < 1 ms; T <sub>h</sub> = 25/80 °C	36 / 24	A
Bridge Rectifier			
V <sub>RRM</sub>		1200	V
I <sub>D</sub>		16	A
I <sub>FSM</sub>		100	A
i <sup>2</sup> t		500	A <sup>2</sup> s
T <sub>j</sub>		- 40 ... + 150	°C
T <sub>stg</sub>		- 40 ... + 125	°C
T <sub>sol</sub>	Terminals, 10 s	260	°C
V <sub>isol</sub>	AC, 1 min	2500	V

Characteristics		min.	typ.	max.	Units
Symbol	Conditions <sup>1)</sup>				
V <sub>CEsat</sub>	I <sub>C</sub> = 25 A; T <sub>j</sub> = 25 (125) °C	-	2,5(3,1)	3,0(3,7)	V
t <sub>d(on)</sub>	V <sub>CC</sub> = 600 V; V <sub>GE</sub> = ± 15 V I <sub>C</sub> = 25 A; T <sub>j</sub> = 125 °C R <sub>Gon</sub> = R <sub>Goff</sub> = 25 Ω inductive load	-	65	-	ns
t <sub>r</sub>		-	100	-	ns
t <sub>d(off)</sub>		-	430	-	ns
t <sub>f</sub>		-	35	-	ns
E <sub>on</sub> + E <sub>off</sub>		-	7	-	mJ
C <sub>ies</sub>	V <sub>CE</sub> = 25 V; V <sub>GE</sub> = 0V, 1 MHz	-	1,65	-	nF
R <sub>thjh</sub> <sup>3)</sup>	per IGBT	-	-	1,0	K/W
Inverse Diode <sup>2)</sup> & Rectifier diode					
V <sub>F</sub> = V <sub>EC</sub>	I <sub>F</sub> = 10 A; T <sub>j</sub> = 25 (125) °C	-	2,0(1,8)	2,5(2,3)	V
V <sub>TO</sub>	T <sub>j</sub> = 125 °C	-	1,0	1,2	V
r <sub>T</sub>	T <sub>j</sub> = 125 °C	-	80	110	mΩ
I <sub>R</sub> RM	I <sub>F</sub> = 10 A; V <sub>R</sub> = 600 V di <sub>F</sub> /dt = - 300 A/μs V <sub>GE</sub> = 0 V; T <sub>j</sub> = 125 °C	-	12	-	A
Q <sub>rr</sub>		-	1,8	-	μC
E <sub>off</sub>		-	0,4	-	mJ
R <sub>thjh</sub> <sup>3)</sup>		per Diode	-	-	2,1
Mechanical Data					
M <sub>1</sub>	mounting torque	-	-	2,5	Nm
w		-	30	-	g
Case			T 23		

#### Features

- Compact design
- One screw mounting
- Heat transfer and isolation through direct copper bonded aluminium oxide ceramic (DCB)
- N channel, homogeneous silicon structure (NPT Non-Punch-through IGBT)
- High short circuit capability
- Fast and soft inverse CAL-diodes
- UL recognized, file no. E 63 532

#### Typical Applications

- Switching (not for linear use)
- Inverter
- Switched mode power supplies
- UPS

<sup>1)</sup> T<sub>h</sub> = 25 °C, unless otherwise specified

<sup>2)</sup> CAL = Controlled Axial Lifetime Technology ( soft and fast recovery)

<sup>3)</sup> Thermal resistance junction to heatsink

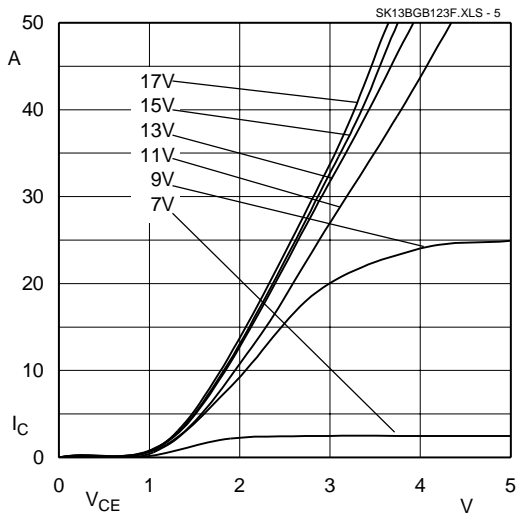

Fig. 5 Typ. output characteristic,  $t_p = 80 \mu s$ ;  $25 \text{ }^\circ\text{C}$

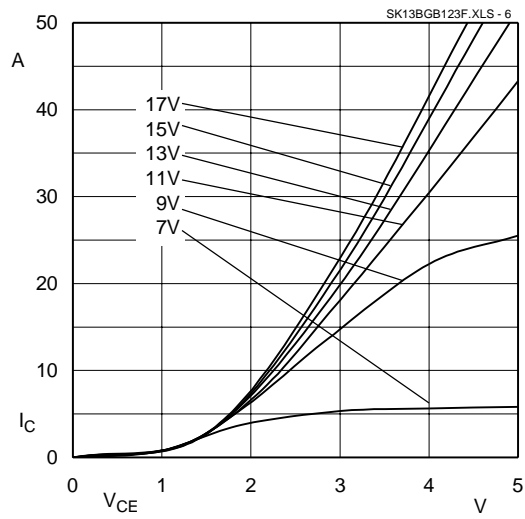

Fig. 6 Typ. output characteristic,  $t_p = 80 \mu s$ ;  $125 \text{ }^\circ\text{C}$

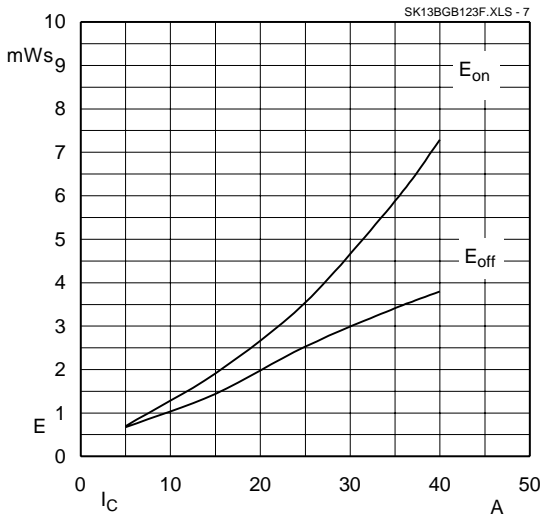

Fig. 7 Turn-on /-off energy =  $f(I_c)$

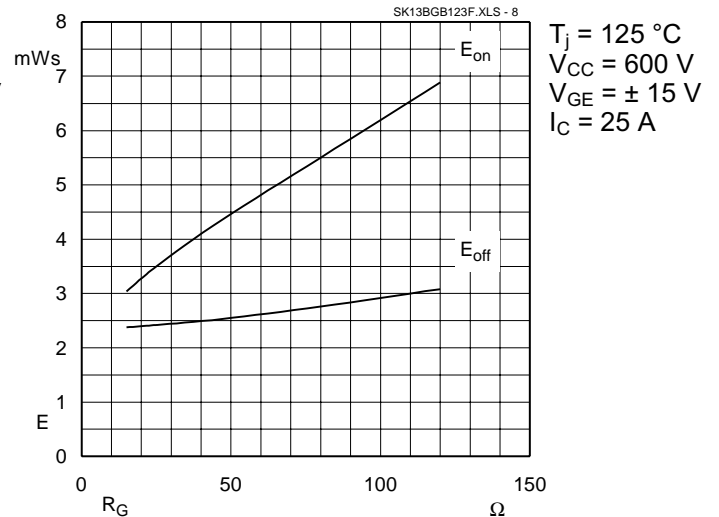

Fig. 8 Turn-on /-off energy =  $f(R_G)$

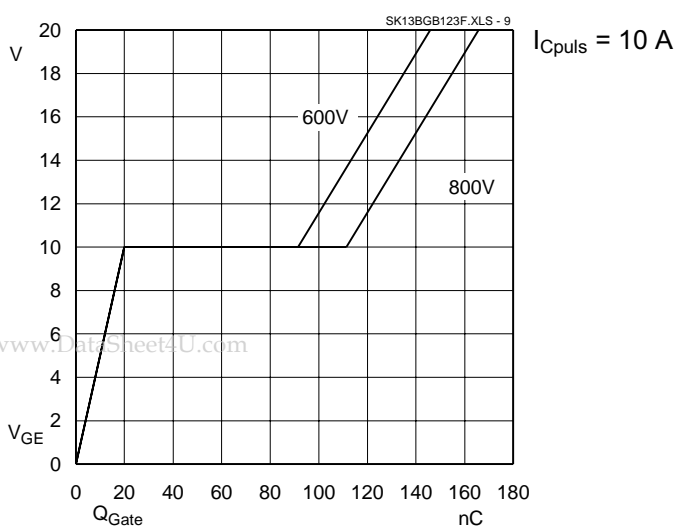

Fig. 9 Typ. gate charge characteristic

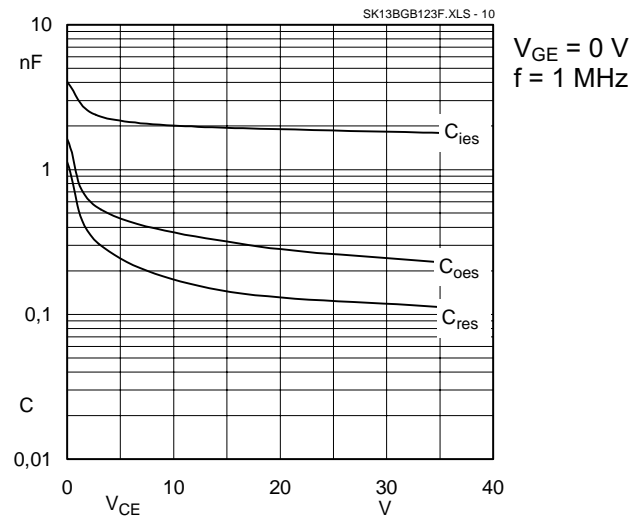

Fig. 10 Typ. capacitances vs.  $V_{CE}$

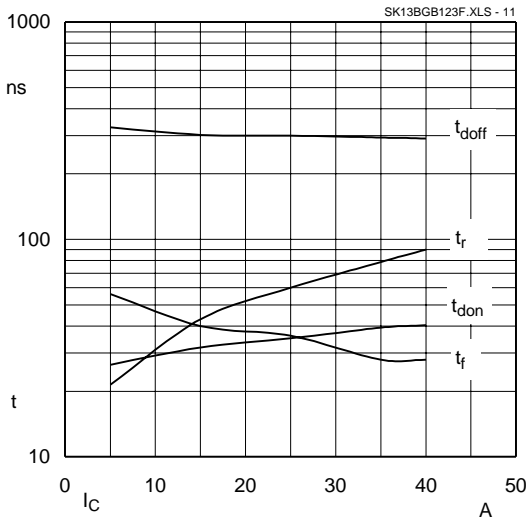

Fig. 11 Typ. switching times vs.  $I_C$

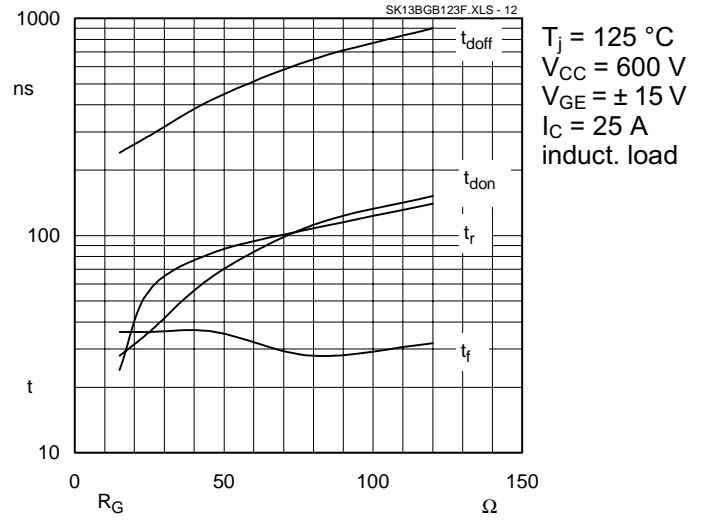

Fig. 12 Typ. switching times vs. gate resistor  $R_G$

# SK 13 BGB 123 F

SEMITOP® 3

SK 13 BGB 123 F

Case T 23

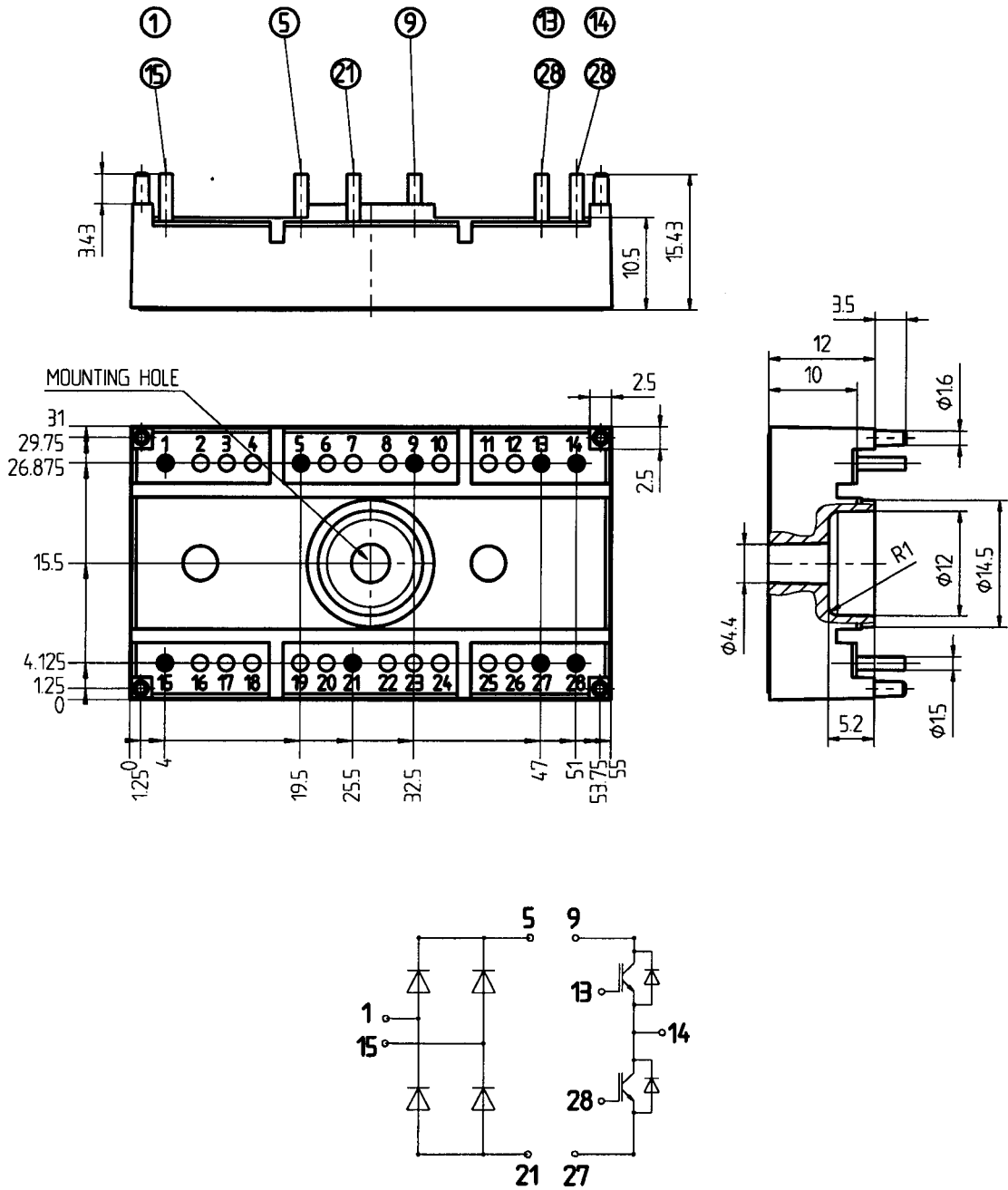

Dimensions in mm