

# SK 15 GD 065 ET

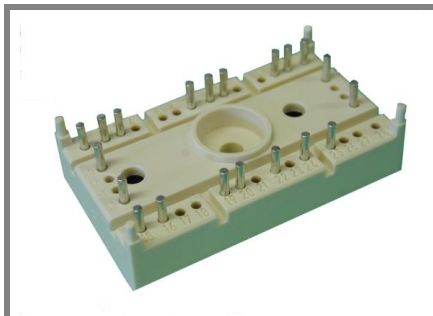

SEMITOP<sup>®</sup> 3

## 3-phase bridge inverter

SK 15 GD 065 ET

Preliminary Data

### Features

- Compact design
- One screw mounting
- Heat transfer and isolation through direct copper bonded aluminum oxide ceramic (DCB)
- Ultrafast NPT technology IGBT
- CAL Technology FWD
- Integrated NTC temperature sensor

### Typical Applications

- Inverter

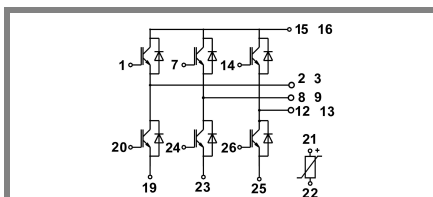

GD - ET

Absolute Maximum Ratings		$T_s = 25^\circ\text{C}$ , unless otherwise specified	
Symbol	Conditions	Values	Units
<b>IGBT - Inverter, Chopper</b>			
$V_{CES}$		600	V
$I_C$	$T_s = 25 (80)^\circ\text{C}$	20 (14)	A
$I_{CM}$	$T_s = 25 (80)^\circ\text{C}$ , $t_p \leq 1 \text{ ms}$	40 (28)	A
$V_{GES}$		$\pm 20$	V
$T_j$		-40 ... +150	$^\circ\text{C}$
<b>Diode - Inverter, Chopper</b>			
$I_F$	$T_s = 25 (80)^\circ\text{C}$	22 (15)	A
$I_{FM} = -I_{CM}$	$T_s = 25 (80)^\circ\text{C}$ , $t_p \leq 1 \text{ ms}$	44 (30)	A
$T_j$		-40 ... +150	$^\circ\text{C}$
<b>Rectifier</b>			
$V_{RRM}$			V
$I_{FAV} / I_{TAV}$	$T_s = ^\circ\text{C}$		A
$I_{FSM} / I_{TSM}$	$t_p = \text{ms}$ , $\sin^\circ$ , $T_j = ^\circ\text{C}$		A
$I_t^2$	$t_p = \text{ms}$ , $\sin^\circ$ , $T_j = ^\circ\text{C}$		$\text{A}^2\text{s}$
$T_j$			$^\circ\text{C}$
$T_{sol}$	Terminals, 10s	260	$^\circ\text{C}$
$T_{stg}$		-40, ... +125	$^\circ\text{C}$
$V_{isol}$	AC, 1 min. / 1s	2500 / 3000	V

Characteristics		$T_s = 25^\circ\text{C}$ , unless otherwise specified			
Symbol	Conditions	min.	typ.	max.	Units
<b>IGBT - Inverter, Chopper</b>					
$V_{CEsat}$	$I_C = 10 \text{ A}$ , $T_j = 25 (125)^\circ\text{C}$		2 (2,2)	2,5	V
$V_{GE(th)}$	$V_{GE} = V_{CE}$ , $I_C = 0,5 \text{ mA}$	3	4	5	V
$V_{CE(TO)}$	$T_j = 25^\circ\text{C}$ (150) $^\circ\text{C}$		1,2 (1,1)	1,3	V
$r_T$	$T_j = 25^\circ\text{C}$ (125) $^\circ\text{C}$		80 (110)	120	m $\Omega$
$C_{ies}$	$V_{CE} = 25 \text{ V}$ , $V_{GE} = 0 \text{ V}$ , $f = 1 \text{ MHz}$		0,8		nF
$C_{oes}$	$V_{CE} = 25 \text{ V}$ , $V_{GE} = 0 \text{ V}$ , $f = 1 \text{ MHz}$		0,2		nF
$C_{res}$	$V_{CE} = 25 \text{ V}$ , $V_{GE} = 0 \text{ V}$ , $f = 1 \text{ MHz}$		0,2		nF
$R_{th(j-s)}$	per IGBT			1,9	K/W
$t_{d(on)}$	under following conditions		45		ns
$t_r$	$V_{CC} = 300 \text{ V}$ , $V_{GE} = \pm 15 \text{ V}$		40		ns
$t_{d(off)}$	$I_C = 10 \text{ A}$ , $T_j = 125^\circ\text{C}$		340		ns
$t_f$	$R_{Gon} = R_{Goff} = 125 \Omega$		90		ns
$E_{on}$	inductive load		0,3		mJ
$E_{off}$			0,22		mJ
<b>Diode - Inverter, Chopper</b>					
$V_F = V_{EC}$	$I_F = 10 \text{ A}$ , $T_j = 25 (125)^\circ\text{C}$		1,4 (1,4)	1,7	V
$V_{(TO)}$	$T_j = 25^\circ\text{C}$ (125) $^\circ\text{C}$		1 (0,9)	1,1	V
$r_T$	$T_j = 25^\circ\text{C}$ (125) $^\circ\text{C}$		45 (50)	60	m $\Omega$
$R_{th(j-s)}$	per diode			2,3	K/W
$I_{RRM}$	under following conditions		11		A
$Q_{rr}$	$I_F = 10 \text{ A}$ , $V_R = 300 \text{ V}$		1,1		$\mu\text{C}$
$E_{rr}$	$V_{GE} = 0 \text{ V}$ , $T_j = 125^\circ\text{C}$		0,24		mJ
	$di_F/dt = 290 \text{ A}/\mu\text{s}$				
<b>Diode rectifier</b>					
$V_F$	$I_F = \text{A}$ , $T_j = 25^\circ\text{C}$				V
$V_{(TO)}$	$T_j = ^\circ\text{C}$				V
$r_T$	$T_j = ^\circ\text{C}$				m $\Omega$
$R_{th(j-s)}$	per diode				K/W
<b>Temperatur sensor</b>					
$R_{ts}$	5 %, $T_r = 25 (100)^\circ\text{C}$		5000(493)		$\Omega$
<b>Mechanical data</b>					
w			30		g
$M_s$	Mounting torque			2,5	Nm

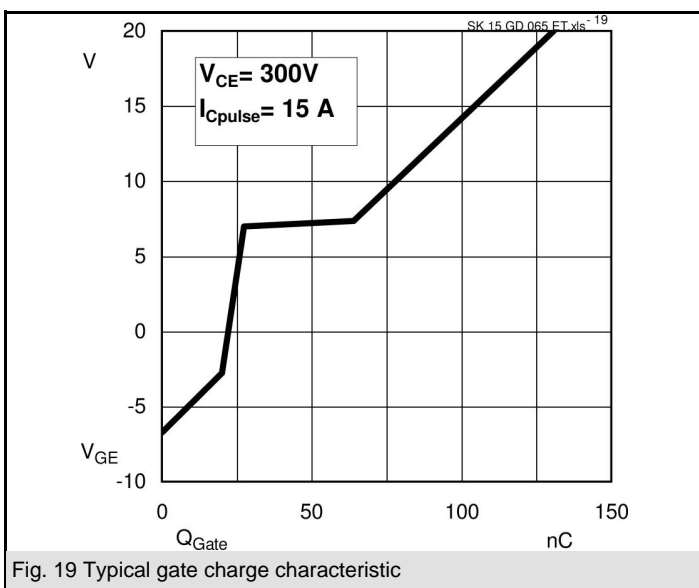
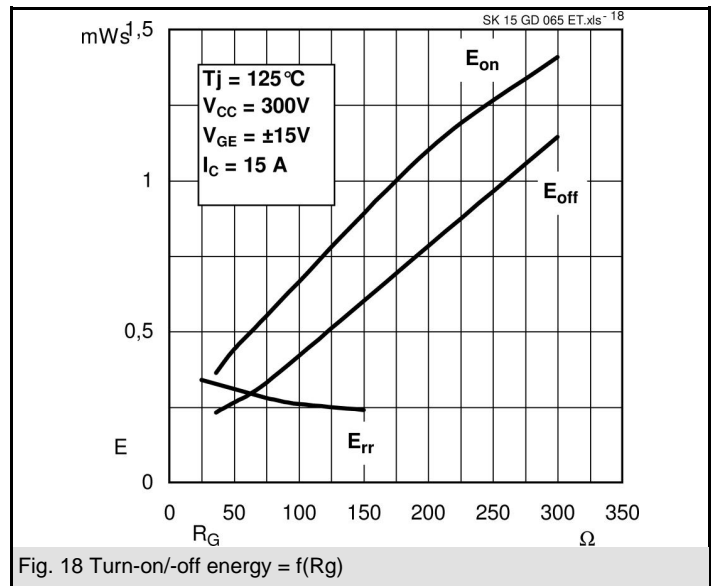
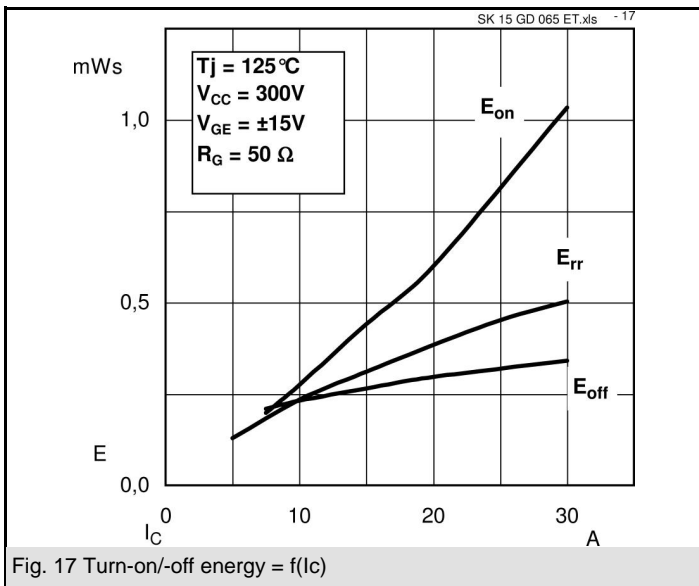
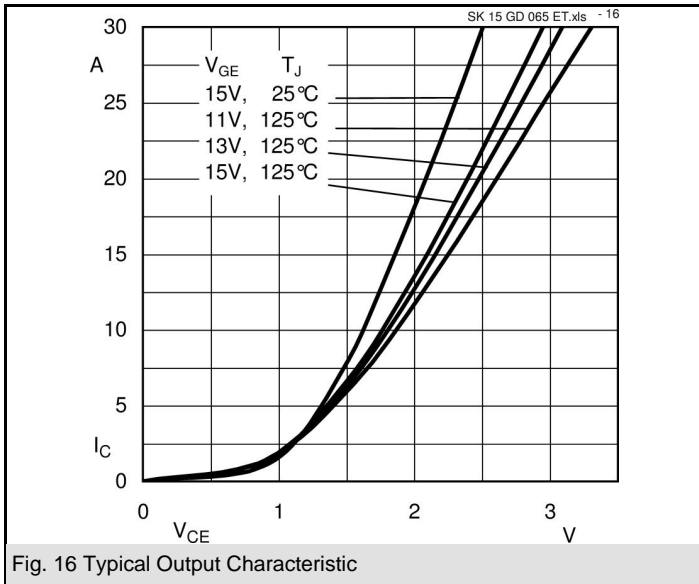

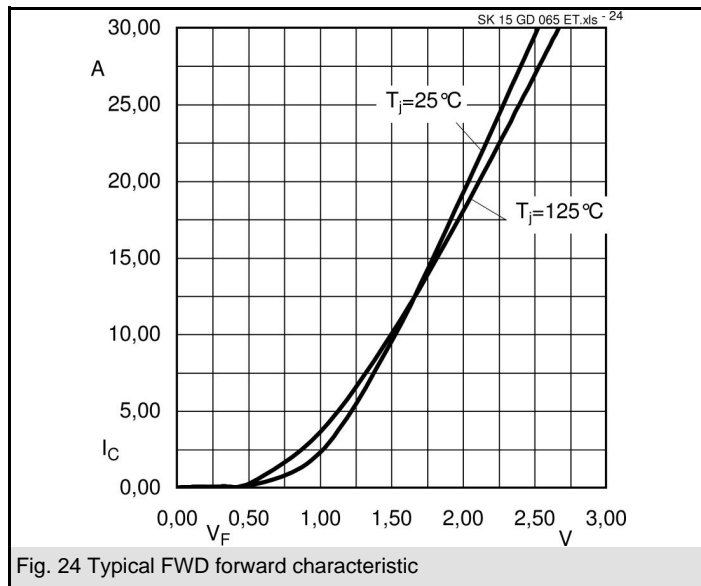
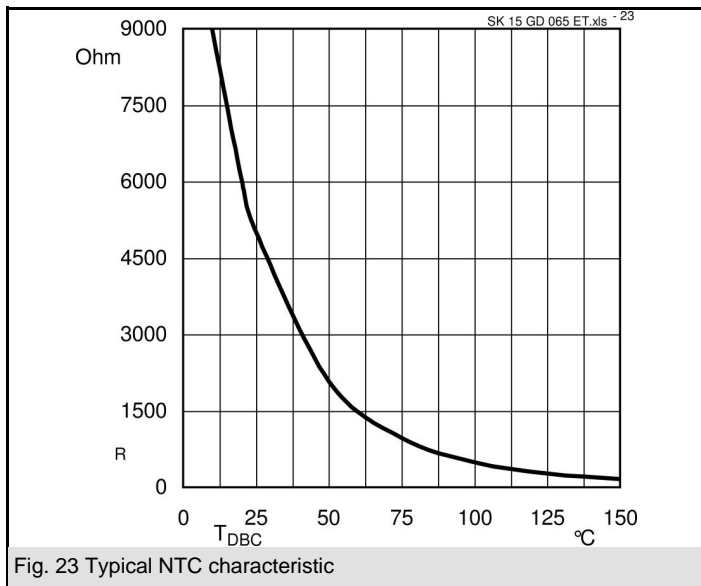
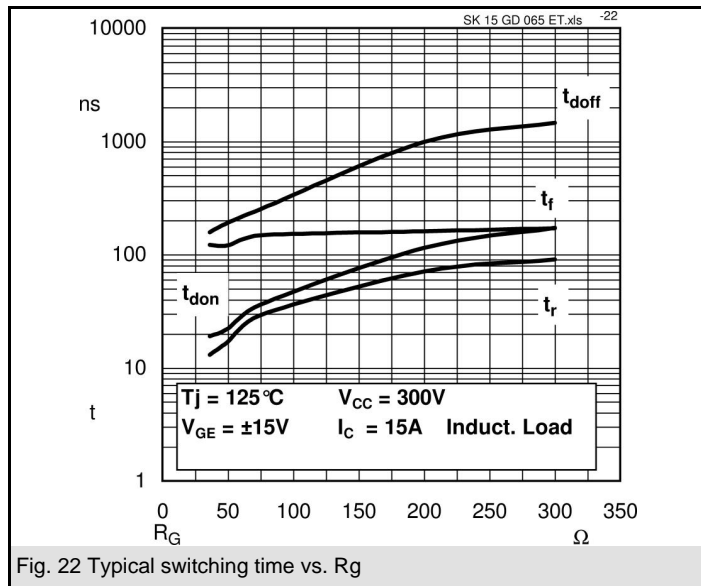
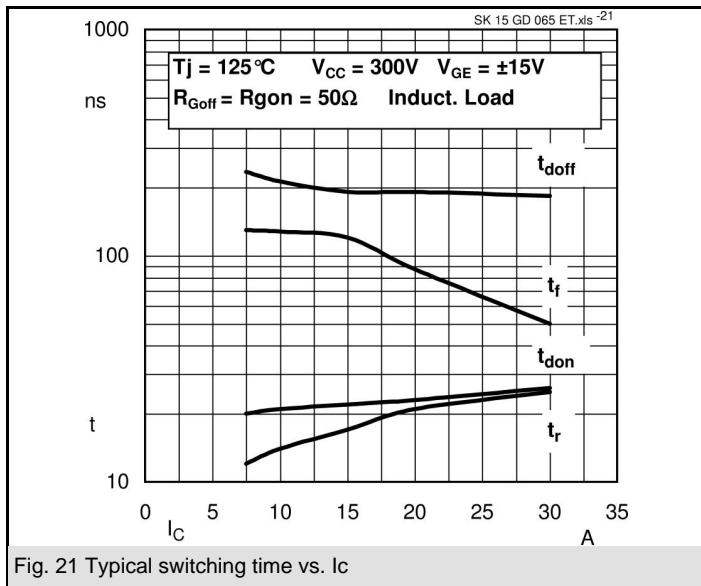

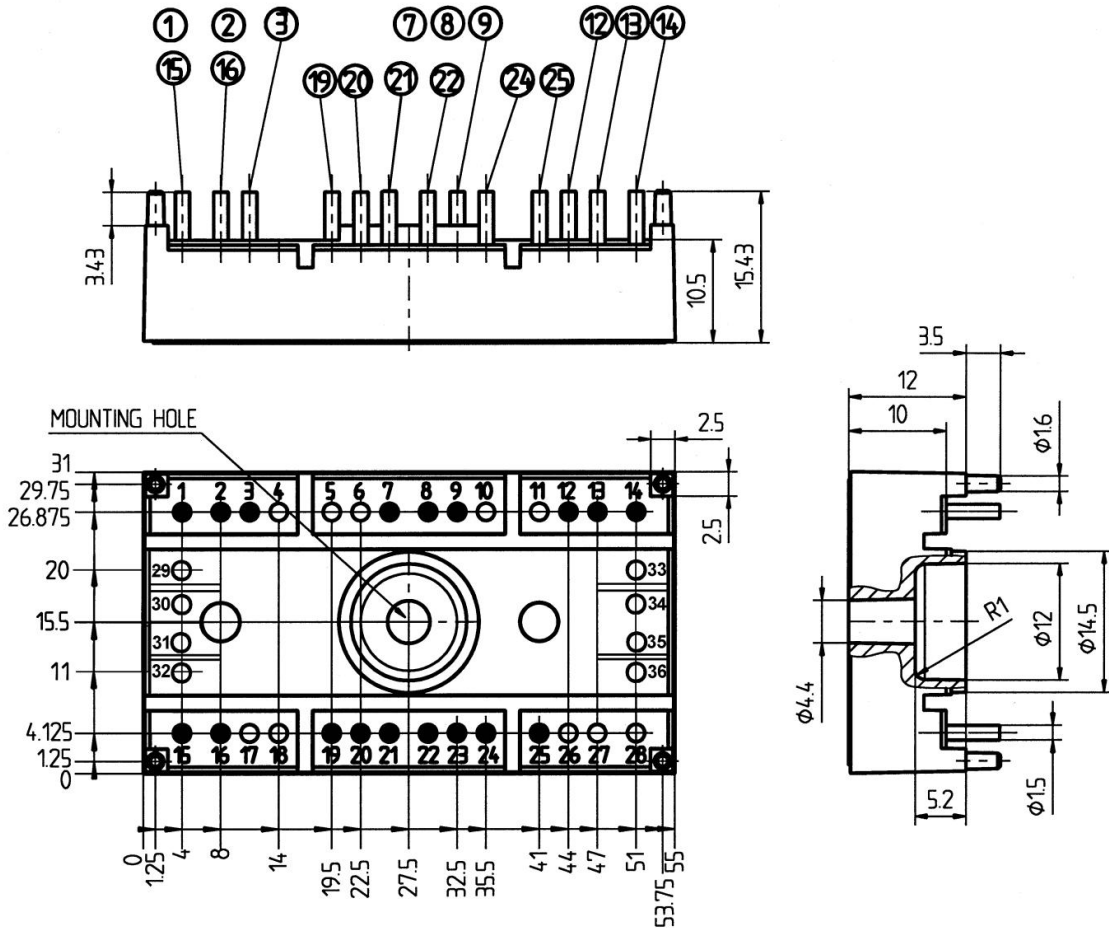

Case T 52 (Suggested hole diameter, in the PCB, for solder pins and plastic mounting pins: 2mm)

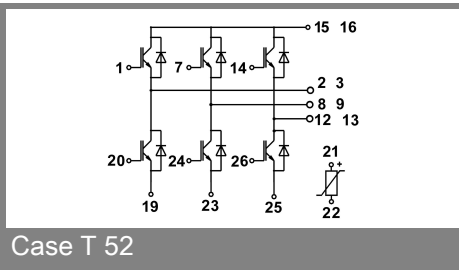

Case T 52

This is an electrostatic discharge sensitive device (ESDS), international standard IEC 60747-1, Chapter IX.

This technical information specifies semiconductor devices but promises no characteristics. No warranty or guarantee expressed or implied is made regarding delivery, performance or suitability.