

SK 74 DGL 063



SEMITOP[®] 3

3-phase bridge rectifier + brake chopper

SK 74 DGL 063

Preliminary Data

Features

- Compact design
- One screw mounting
- Heat transfer and isolation through direct copper bonded aluminum oxide ceramic (DCB)
- Ultrafast NPT technology IGBT
- CAL Technology FW

Typical Applications*

- Rectifier

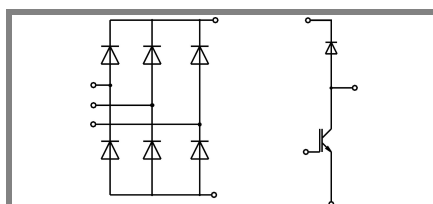

DGL

Absolute Maximum Ratings		$T_s = 25^\circ\text{C}$, unless otherwise specified	
Symbol	Conditions	Values	Units
IGBT - Chopper			
V_{CES}		600	V
I_C	$T_s = 25 (80)^\circ\text{C}$	45 (32)	A
I_{CRM}	$I_{CRM} = 2 \times I_{Cnom}$, $t_p = 1 \text{ ms}$	100	A
V_{GES}		± 20	V
T_j		-40 ... +150	$^\circ\text{C}$
Diode - Chopper			
I_F	$T_s = 25 (80)^\circ\text{C}$	36 (24)	A
I_{FRM}	$I_{FRM} = 2 \times I_{Fnom}$, $t_p = 1 \text{ ms}$	70	A
T_j		-40 ... +150	$^\circ\text{C}$
Rectifier			
V_{RRM}		800	V
I_D	$T_s = 80^\circ\text{C}$	74	A
I_{FSM} / I_{TSM}	$t_p = 10 \text{ ms}$, $\sin 180^\circ$, $T_j = 25^\circ\text{C}$	370	A
I_t^2	$t_p = 10 \text{ ms}$, $\sin 180^\circ$, $T_j = 25^\circ\text{C}$	685	A^2s
T_j		-40 ... +150	$^\circ\text{C}$
T_{sol}	Terminals, 10s	260	$^\circ\text{C}$
T_{stg}		-40 ... +125	$^\circ\text{C}$
V_{isol}	AC, 1 min. / 1s	2500 / 3000	V

Characteristics		$T_s = 25^\circ\text{C}$, unless otherwise specified			
Symbol	Conditions	min.	typ.	max.	Units
IGBT - Chopper					
V_{CEsat}	$I_C = 30 \text{ A}$, $T_j = ()^\circ\text{C}$		1,8 (2)	2,1 (2,3)	V
$V_{GE(th)}$	$V_{GE} = V_{CE}$, $I_C = 0,5 \text{ mA}$	3	4	5	V
$V_{CE(TO)}$	$T_j = 25^\circ\text{C} (125)^\circ\text{C}$		0,85 (0,9)		V
r_T	$T_j = 25^\circ\text{C} (125)^\circ\text{C}$		19 (22)		m Ω
C_{ies}	$V_{CE} = 25 \text{ V}$, $V_{GE} = 0 \text{ V}$, $f = 1 \text{ MHz}$		2,6		nF
C_{oes}	$V_{CE} = V_{GE} = 0 \text{ V}$, $f = 1 \text{ MHz}$		-		nF
C_{res}	$V_{CE} = V_{GE} = 0 \text{ V}$, $f = 1 \text{ MHz}$		-		nF
$R_{th(j-s)}$	per IGBT			1	K/W
$t_{d(on)}$	under following conditions		45		ns
t_r	$V_{CC} = 300 \text{ V}$, $V_{GE} = \pm 15 \text{ V}$		40		ns
$t_{d(off)}$	$I_C = 30 \text{ A}$, $T_j = ^\circ\text{C}$		250		ns
t_f	$R_{Gon} = R_{Goff} = 22 \Omega$		30		ns
E_{on}	inductive load		1,45		mJ
E_{off}			1,2		mJ
Diode - Chopper					
$V_F = V_{EC}$	$I_F = 30 \text{ A}$, $T_j = ()^\circ\text{C}$		1,45 (1,4)	1,7 (1,75)	V
$V_{(TO)}$	$T_j = ^\circ\text{C} (125)^\circ\text{C}$		(0,85)	(0,9)	V
r_T	$T_j = ^\circ\text{C} (125)^\circ\text{C}$		(22)	(16)	m Ω
$R_{th(j-s)}$	per diode			1,7	K/W
I_{RRM}	under following conditions		16		A
Q_{rr}	$I_F = 25 \text{ A}$, $V_R = 300 \text{ V}$		2		μC
E_{rr}	$V_{GE} = 0 \text{ V}$, $T_j = ^\circ\text{C}$		25		mJ
	$di_F/dt = 500 \text{ A}/\mu\text{s}$				
Diode rectifier					
V_F	$I_F = 30 \text{ A}$, $T_j = ()^\circ\text{C}$		1,25		V
$V_{(TO)}$	$T_j = 150^\circ\text{C}$		0,8		V
r_T	$T_j = 150^\circ\text{C}$		13		m Ω
$R_{th(j-s)}$	per diode			1,7	K/W
Temperatur sensor					
R_{ts}	%, $T_r = ()^\circ\text{C}$		()		Ω
Mechanical data					
w			30		g
M_s	Mounting torque	2,25		2,5	Nm

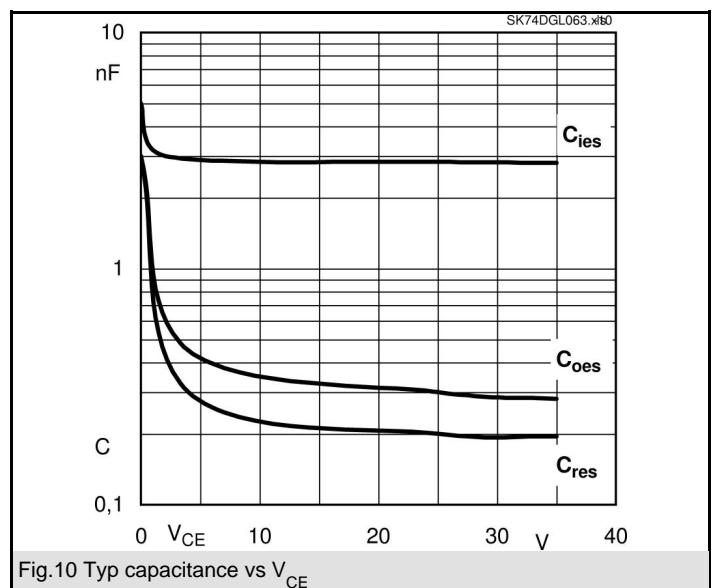
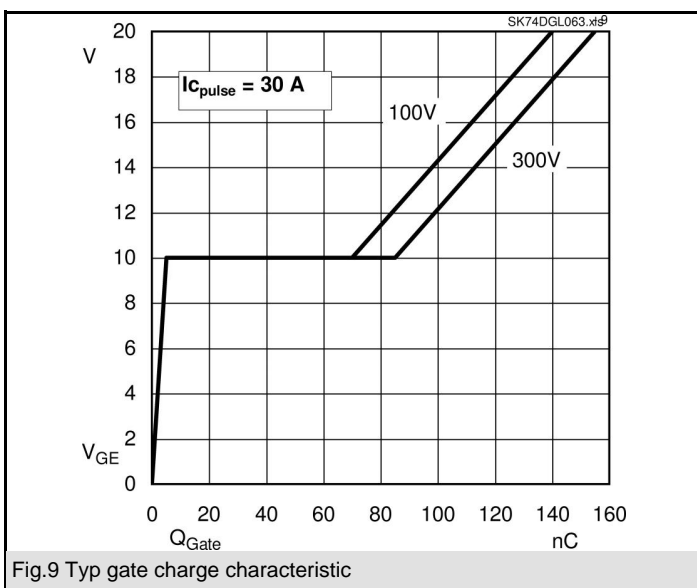
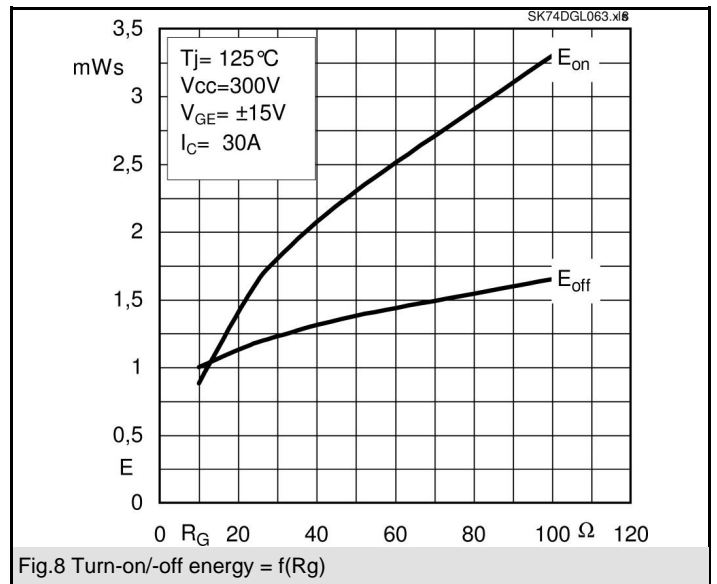
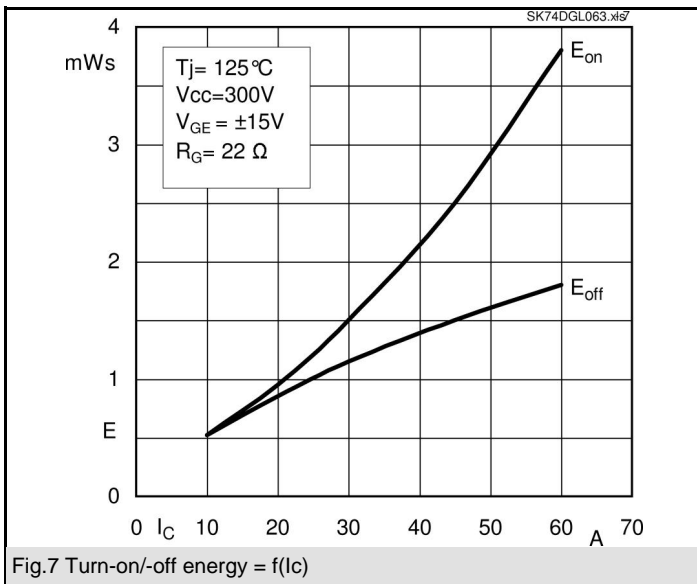
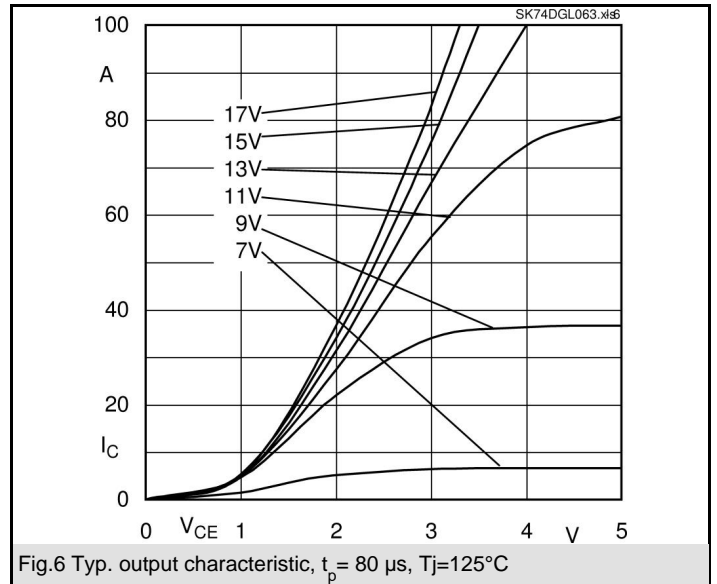
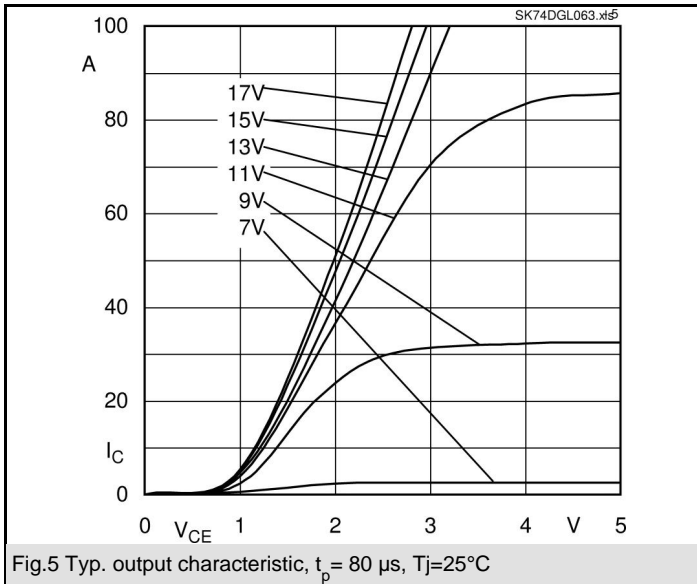

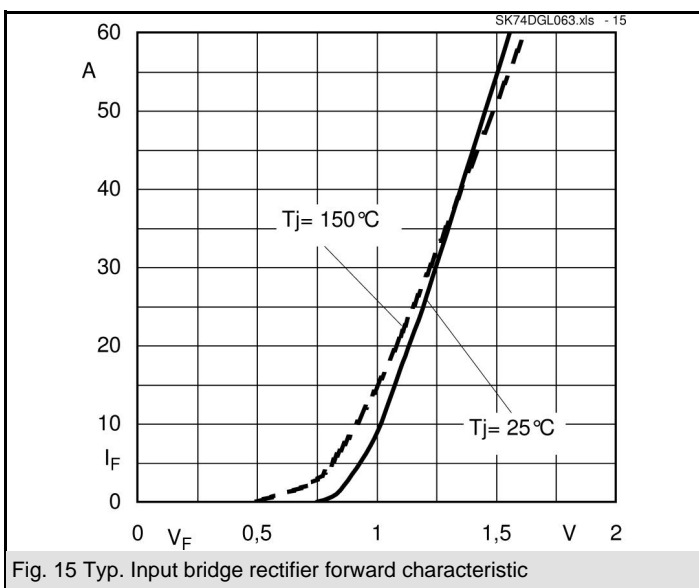
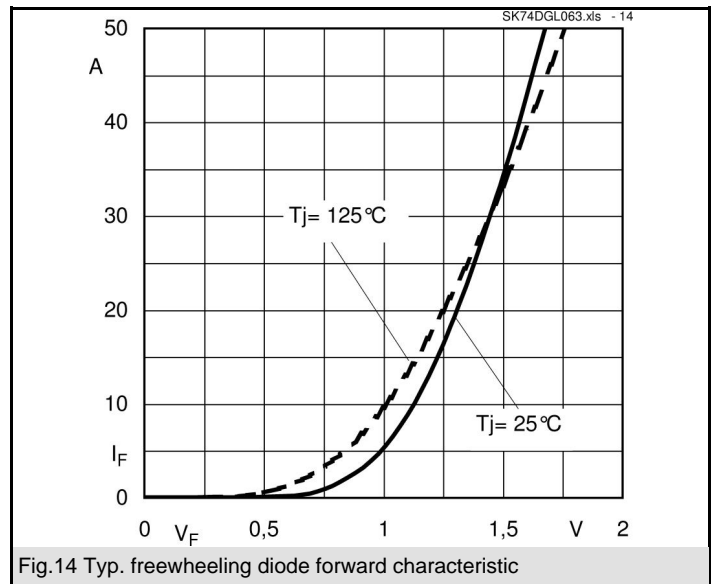
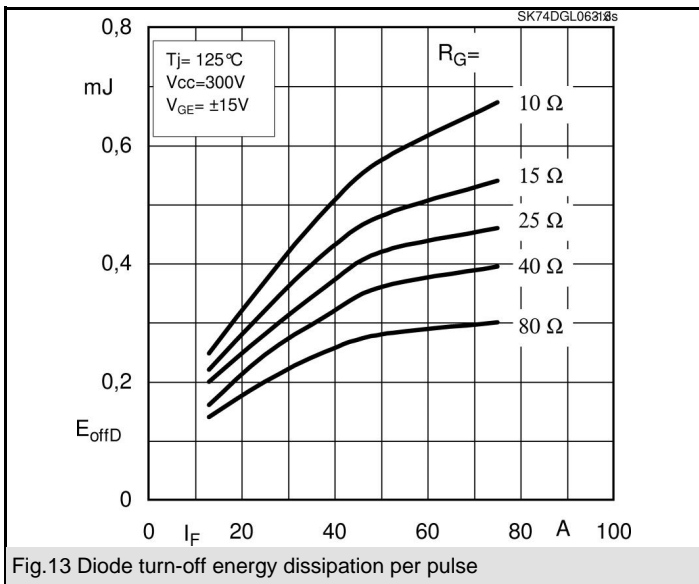
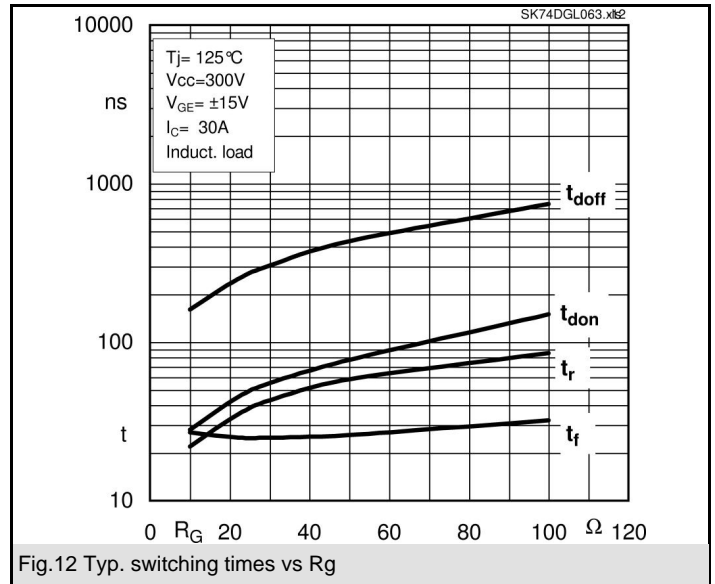
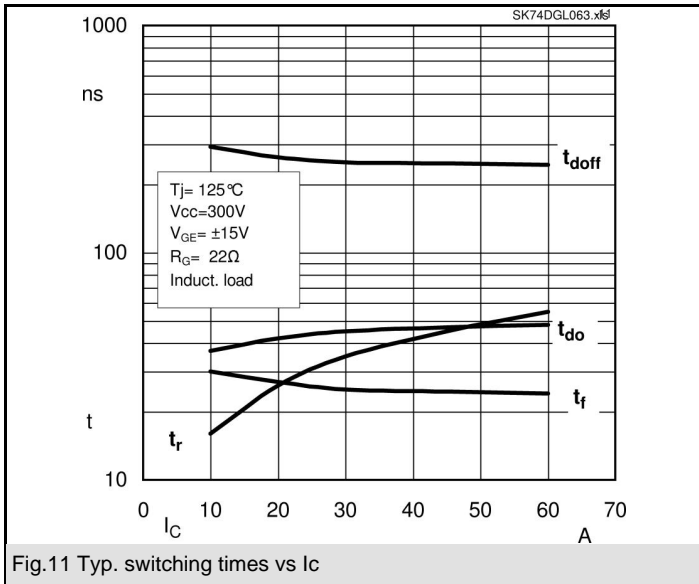

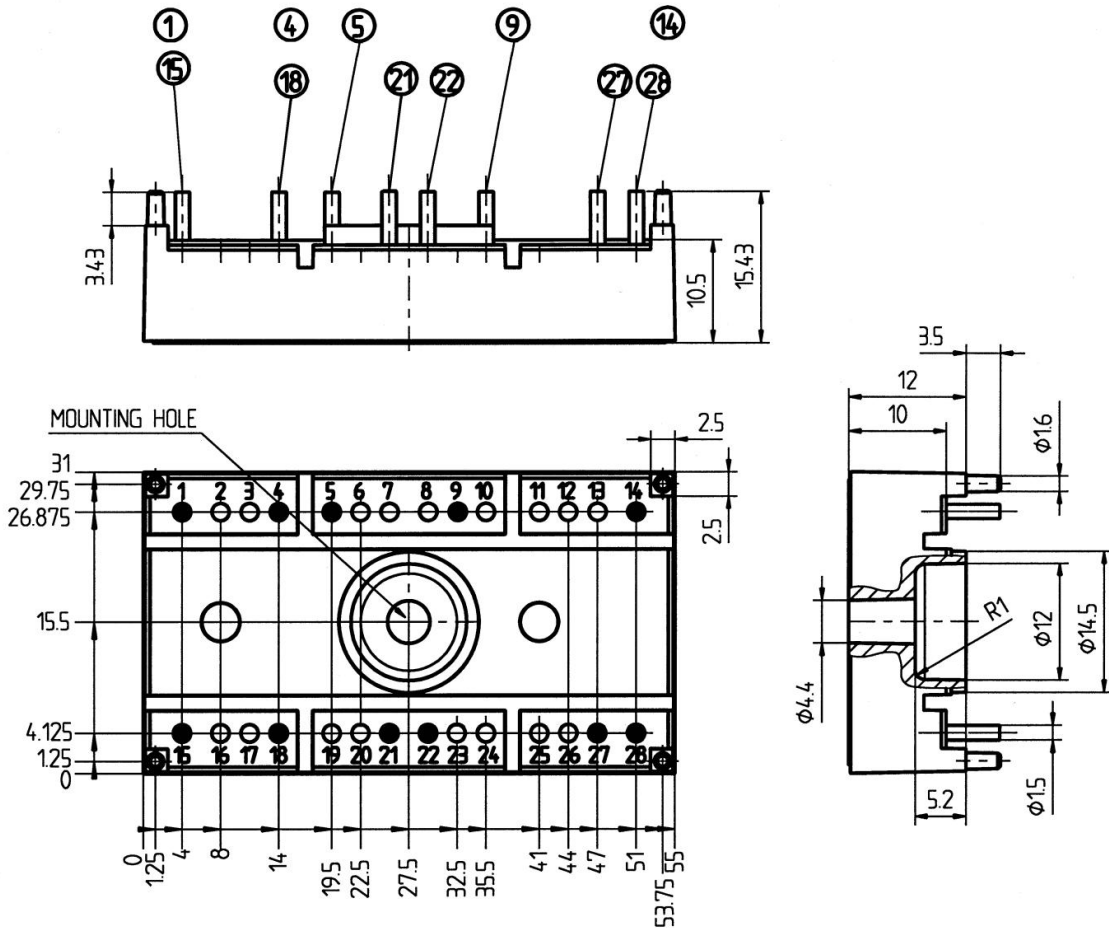

Case T 14 (Suggested hole diameter, in the PCB, for solder pins and plastic mounting pins: 2mm)

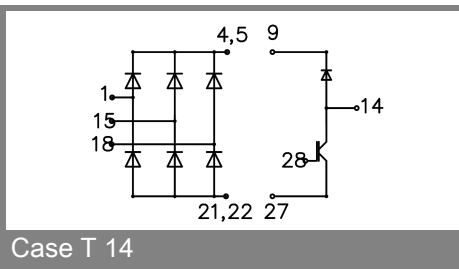

Case T 14

This is an electrostatic discharge sensitive device (ESDS), international standard IEC 60747-1, Chapter IX.

* The specifications of our components may not be considered as an assurance of component characteristics. Components have to be tested for the respective application. Adjustments may be necessary. The use of SEMIKRON products in life support appliances and systems is subject to prior specification and written approval by SEMIKRON. We therefore strongly recommend prior consultation of our personal.