

SK 80 D 12 F

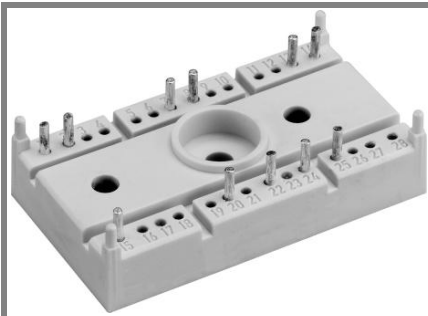

SEMITOP® 3

Bridge Rectifier

SK 80 D 12 F

Preliminary Data

Features

- Compact design
- One screw mounting
- Heat transfer and insulation through direct copper bonded aluminium oxide ceramic (DCB)
- Fast and soft recovery CAL (Controlled Axial Lifetime) diode
- UL recognized, file no. E 63 532

Typical Applications

- General power switching applications
- UPS
- SMPS

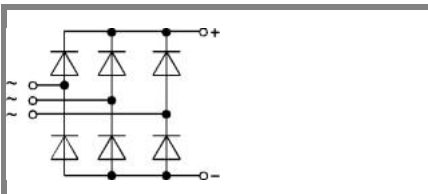

D

V_{RSM} V	V_{RRM}, V_{DRM} V	$I_D = 80$ A (full conduction) ($T_s = 80$ °C)
	1200	SK 80 D 12 F

Symbol	Conditions	Values	Units
I_D	$T_s = 80$ °C	80	A
I_{RRM}	$T_{vj} = 125$ °C (See Fig. 6)	typ. 40	A
Q_{rr}	$T_{vj} = 25$ (125) °C (See Fig. 6)	typ. 1,5 (2,7)	μC
I_R	$T_{vj} = 25$ (150) °C; $V_R = V_{RRM}$	0,2 (4)	mA
I_{FSM}	$T_{vj} = 150$ °C; 10 ms	550	A
i^2t	$T_{vj} =$ °C; ms		A
	$T_{vj} = 150$ °C; 10 ms	1500	A ² s
	$T_{vj} =$ °C; ms		A ² s
V_F	$T_{vj} = 25$ °C; $I_F = 75$ A	max. 2,5	V
$V_{(TO)}$	$T_{vj} = 125$ °C	max. 1,2	V
r_T	$T_{vj} = 125$ °C	max. 22	mΩ
I_{RD}	$T_{vj} =$ °C; $V_{DD} = V_{DRM}$; $V_{RD} = V_{RRM}$		mA mA
$R_{th(j-s)}$	per diode per module	0,9 0,15	K/W K/W
T_{solder}	terminals, 10s	260	°C
T_{vj}		-40...+150	°C
T_{stg}		-40...+125	°C
V_{isol}	a. c. 50 Hz; r.m.s.; 1 s / 1 min.	3000 (2500)	V
M_s	mounting torque to heatsink	2,5	Nm
M_t			
m	approx. weight	30	g
Case	SEMITOP® 3	T 25	

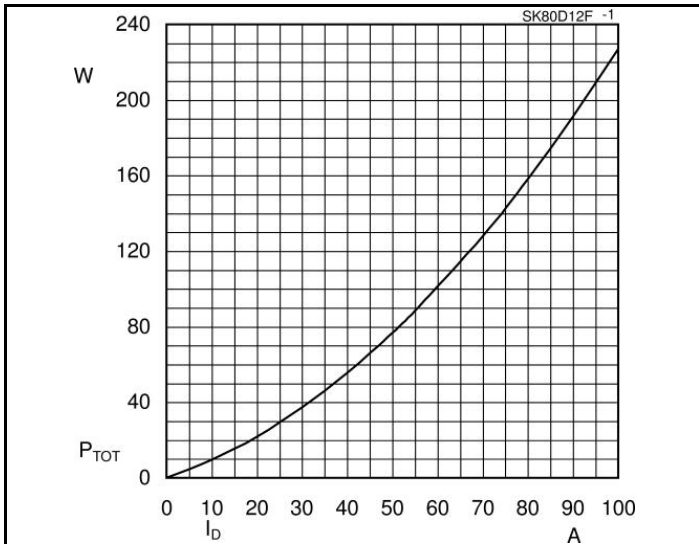

Fig. 1 Power dissipation vs. Output current

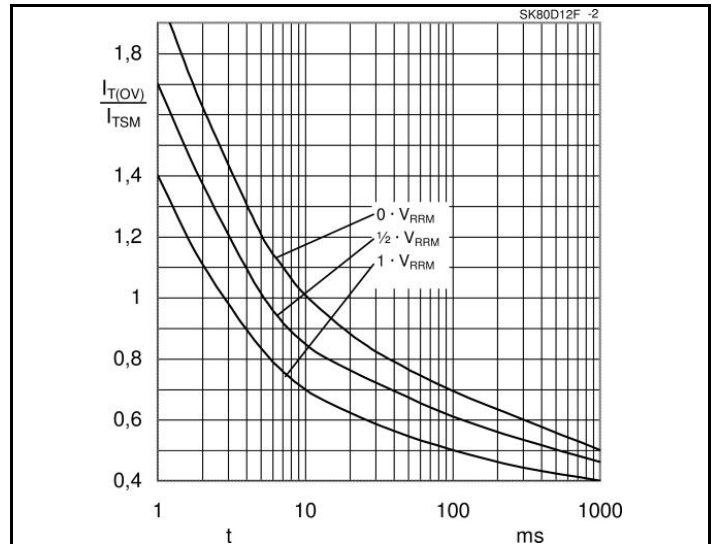

Fig. 2 Surge overload current vs. time

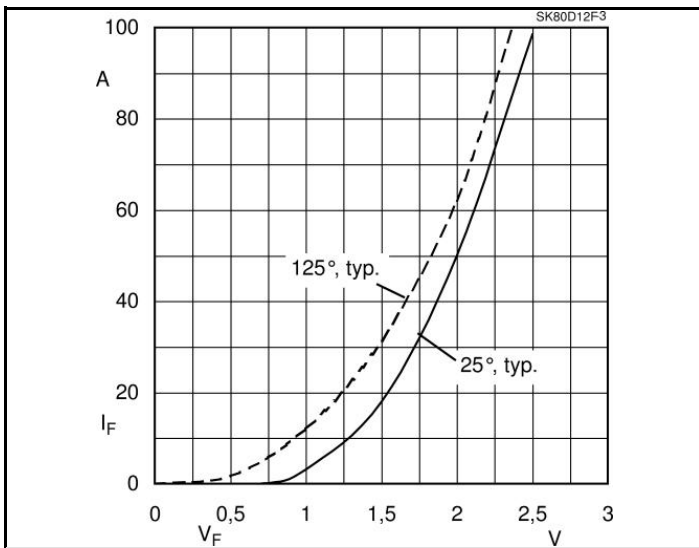

Fig. 3 Forward characteristics of single diode

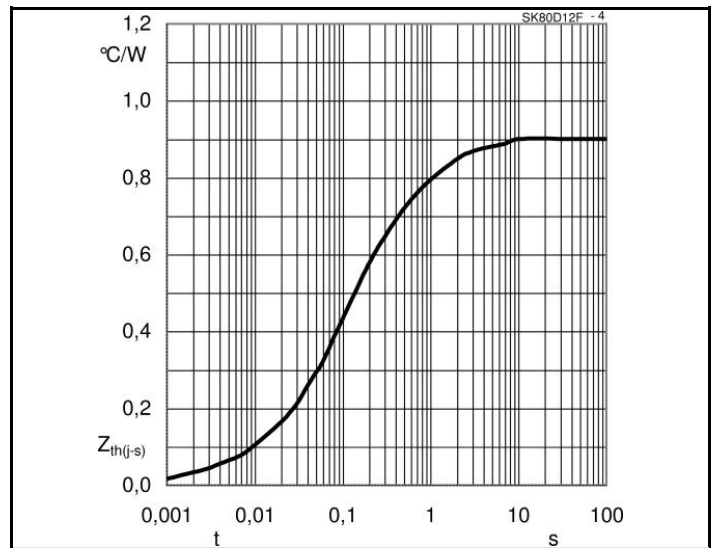

Fig. 4 Thermal transient impedance vs. time

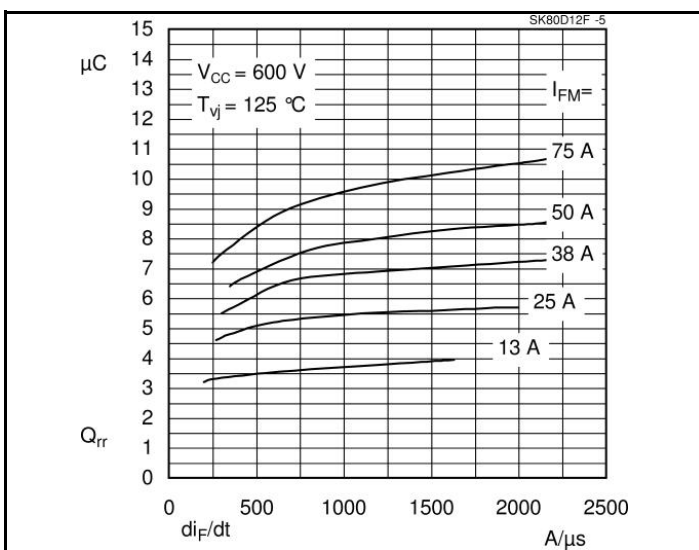

Fig. 5 Typ. reverse recovery charge $Q_{rr} = f(di_F/dt)$

Measurement conditions for switching parameters:

$I_F = 50A$
 $V_R = 600V$
 $-di/dt = 800A/\mu s$

Fig. 6

SK 80 D 12 F

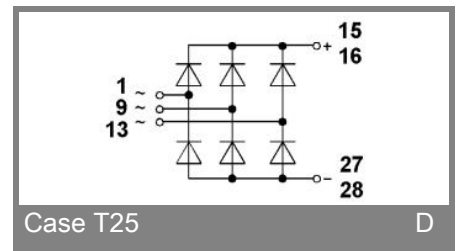
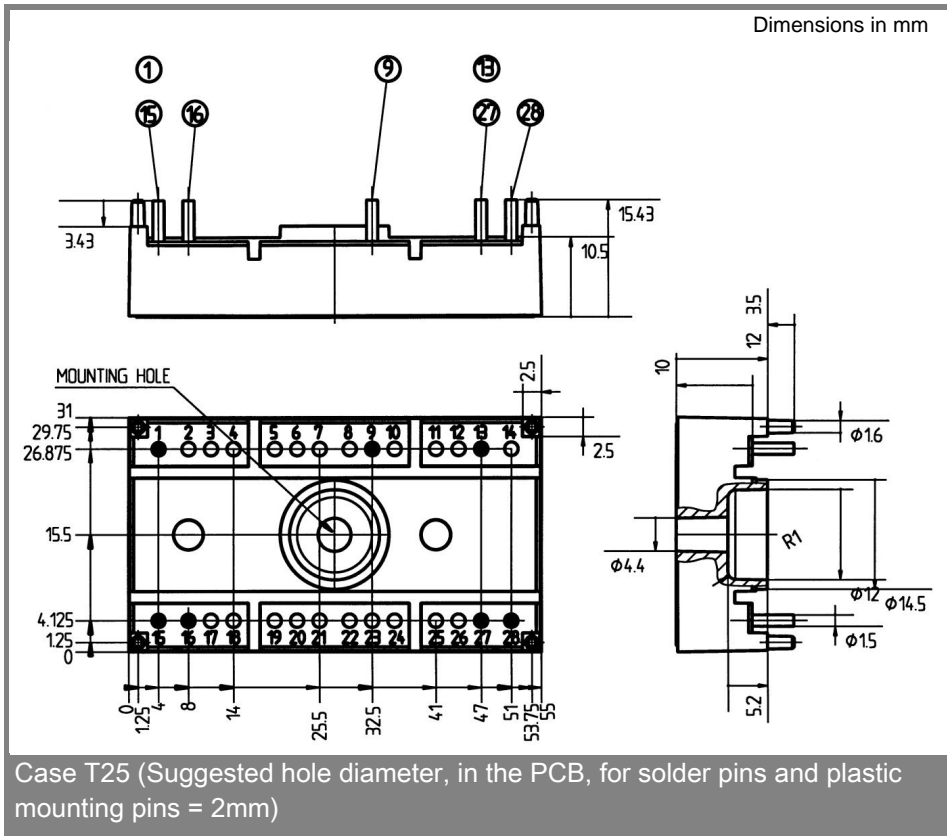

This technical information specifies semiconductor devices but promises no characteristics. No warranty or guarantee expressed or implied is made regarding delivery, performance or suitability.