

SEMIPONT® 2 Power Bridge Rectifiers

SKB 60
SKD 60
SKD 100

V_{RSM} V_{RRM}	I_D ($T_{case} = \dots \text{ }^\circ\text{C}$)		
	60 A (88 °C)	60 A (102 °C)	100 A (93 °C)
400 V	SKB 60/04	SKD 60/04	SKD 100/04
800 V	SKB 60/08	SKD 60/08	SKD 100/08
1200 V	SKB 60/12	SKD 60/12	SKD 100/12
1400 V	SKB 60/14	SKD 60/14	SKD 100/14
1600 V	SKB 60/16	SKD 60/16	SKD 100/16



Symbol	Conditions	SKB60	SKD60	SKD100	Units	
I_D	$T_{case} = 85 \text{ }^\circ\text{C}$; inductive load	67	92	110	A	
	$T_{amb} = 45 \text{ }^\circ\text{C}$, chassis ¹⁾	P13A/125	20	21	24	A
		R4A/120	25	27	28	A
		P1A/120	44	48	54	A
		$T_{amb} = 35 \text{ }^\circ\text{C}$, P1A/120 F	44	48	54	A
	P1A/200 F	88	112	120	A	
I_{FSM}	$T_{vj} = 25 \text{ }^\circ\text{C}$, 10 ms	1000	1000	1150	A	
	$T_{vj} = 125 \text{ }^\circ\text{C}$, 10 ms	850	850	1000	A	
i^2t	$T_{vj} = 25 \text{ }^\circ\text{C}$, 8,3...10 ms	5000	5000	6600	A ² s	
	$T_{vj} = 125 \text{ }^\circ\text{C}$, 8,3...10 ms	3600	3600	5000	A ² s	
V_F	$T_{vj} = 25 \text{ }^\circ\text{C}$; $I_F = 150 \text{ A}$	1,6	1,6	1,35	V	
$V_{(TO)}$	$T_{vj} = 125 \text{ }^\circ\text{C}$	0,85	0,85	0,85	V	
r_T	$T_{vj} = 125 \text{ }^\circ\text{C}$	5	5	5	mΩ	
I_{RD}	$T_{vj} = 25/125 \text{ }^\circ\text{C}$; $V_{RD} = V_{RRM}$	0,5/2	0,5/2	0,5/2	mA	
R_{thjc}	per diode	1,0	1,0	0,85	°C/W	
	total	0,25	0,167	0,14	°C/W	
R_{thch}	total		0,05		°C/W	
T_{vj}			- 40...+ 125		°C	
T_{stg}			- 40...+ 125		°C	
V_{isol}	a.c.50...60Hz; r.m.s.; 1s/1min		3600 / 3000		V~	
M_1	to heatsink	SI units	5 ± 15 %		Nm	
		US units	44 ± 15 %		lb. in.	
M_2	to terminals	SI units	5 ± 15 %		Nm	
		US units	44 ± 15 %		lb. in.	
w			165		g	
Case		G 17	G 18	G 18		

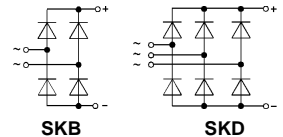

Features

- Robust plastic case with screw terminals
- Large, isolated base plate
- Blocking voltage to 1600 V
- High surge currents
- **SKB** = single phase bridge rectifier
- **SKD** = three phase bridge rectifier
- Easy chassis mounting
- UL recognized, file no. E 63 532

Typical Applications

- Single and three phase rectifiers for power supplies
- Input rectifiers for variable frequency drives
- Rectifiers for DC motor field supplies
- Battery charger rectifiers

www.DataSheet4U.com

¹⁾ Painted metal sheet of minimum 250 x 250 x 1 mm: $R_{thca} = 1,8 \text{ }^\circ\text{C/W}$

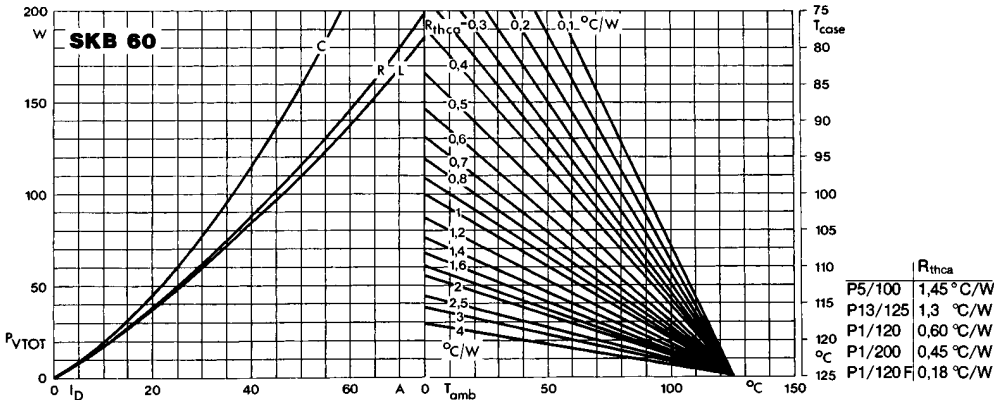

Fig. 3 a Power dissipation vs. output current and case temperature

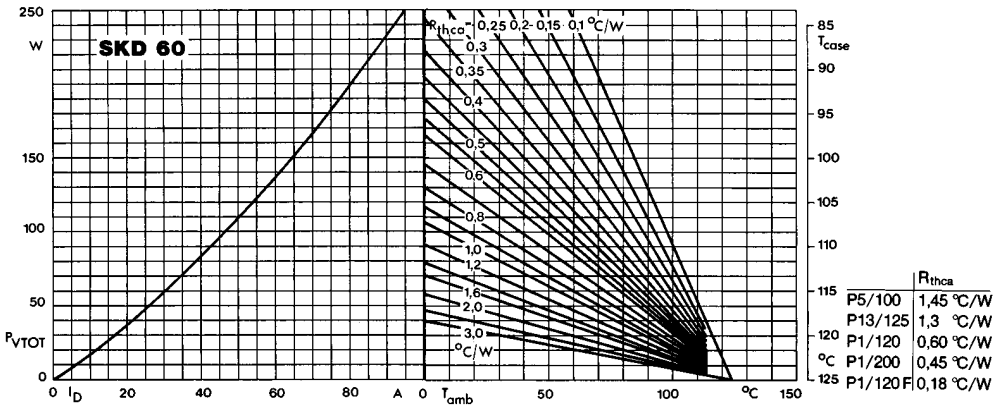

Fig. 3 b Power dissipation vs. output current and case temperature

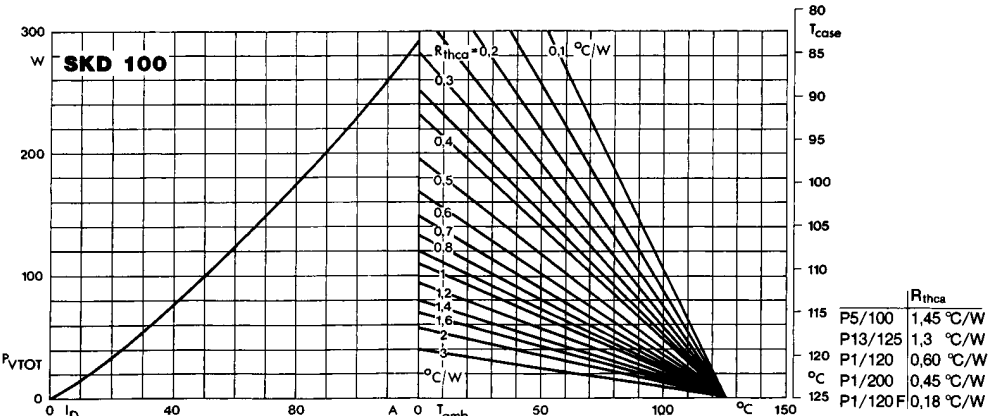

Fig. 3 c Power dissipation vs. output current and case temperature

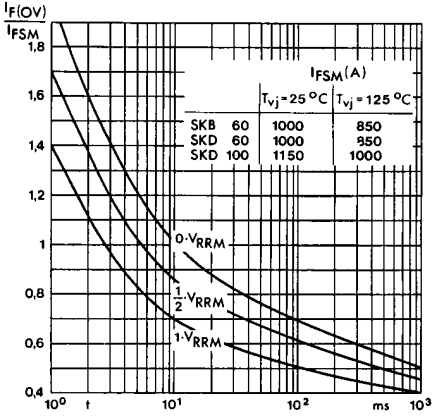

Fig. 5 Surge overload current vs. time

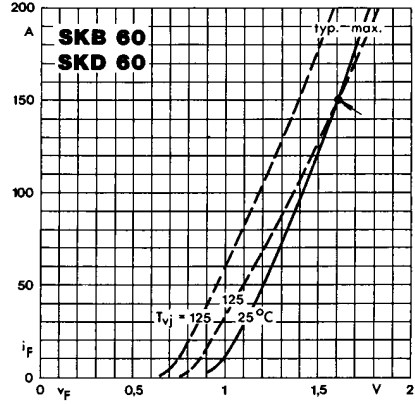

Fig. 9 a Forward characteristics of a single diode

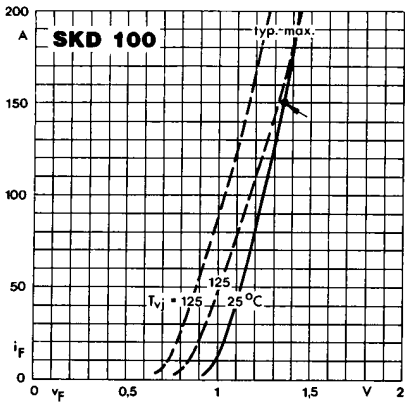

Fig. 9 b Forward characteristics of a single diode

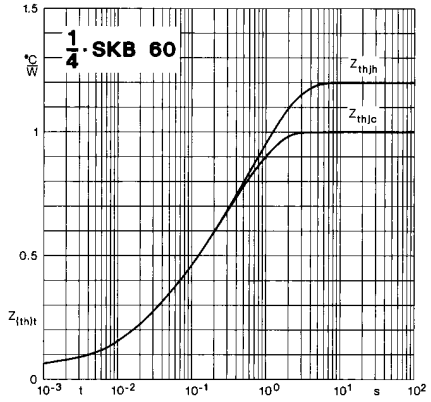

Fig. 12 a Transient thermal impedance vs. time

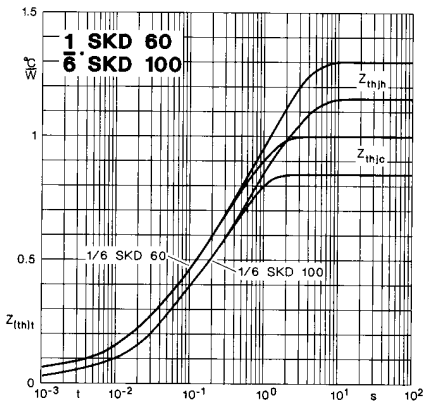
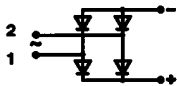
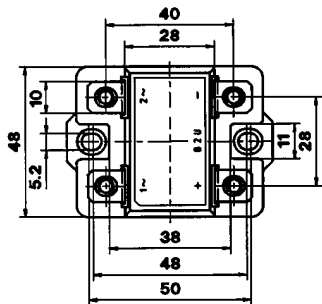
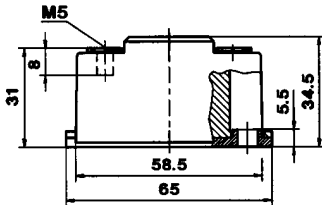

Fig. 12 b Transient thermal impedance vs. time

SKB 60

Case G 17
SEMIPONT® 2



Dimensions in mm

SKD 60
SKD 100

Case G 18
SEMIPONT® 2

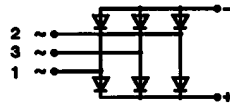
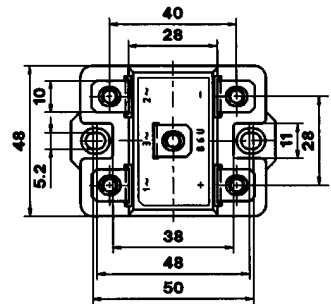
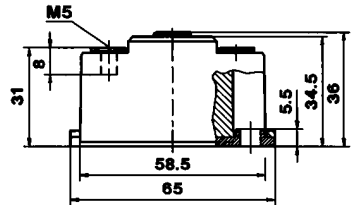

Dimensions in mm