

## SKiiP 21 NAB 063 T1, SKiiP 21 NAB 063 I T1

Absolute Maximum Ratings		Values	Units
Symbol	Conditions <sup>1)</sup>		
Inverter			
V <sub>CES</sub>		600	V
V <sub>GES</sub>		± 20	V
I <sub>C</sub>	T <sub>heatsink</sub> = 25 / 80 °C	24 / 17	A
I <sub>CM</sub>	t <sub>p</sub> < 1 ms; T <sub>heatsink</sub> = 25 / 80 °C	48 / 34	A
I <sub>F</sub> = -I <sub>C</sub>	T <sub>heatsink</sub> = 25 / 80 °C	36 / 24	A
I <sub>FM</sub> = -I <sub>CM</sub>	t <sub>p</sub> < 1 ms; T <sub>heatsink</sub> = 25 / 80 °C	72 / 48	A
Bridge Rectifier			
V <sub>R<sub>RM</sub></sub>		800	V
I <sub>D</sub>	T <sub>heatsink</sub> = 80 °C	25	A
I <sub>FSM</sub>	t <sub>p</sub> = 10 ms; sin. 180 °, T <sub>J</sub> = 25 °C	370	A
I <sup>2</sup> t	t <sub>p</sub> = 10 ms; sin. 180 °, T <sub>J</sub> = 25 °C	680	A <sup>2</sup> s
T <sub>J</sub>		- 40 ... + 150	°C
T <sub>stg</sub>		- 40 ... + 125	°C
V <sub>isol</sub>	AC, 1 min.	2500	V

**MiniSKiiP 2**  
**SEMIKRON integrated intelligent Power**  
**SKiiP 21 NAB 063 T1**  
**SKiiP 21 NAB 063 I T1** <sup>3)</sup>  
**3-phase bridge rectifier + braking chopper + 3-phase bridge inverter**

Case M2

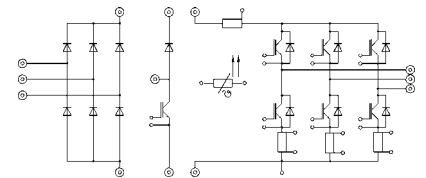

UL recognized file no. E63532

- fast NPT IGBTs

- <sup>1)</sup> T<sub>heatsink</sub> = 25 °C, unless otherwise specified
- <sup>2)</sup> CAL = Controlled Axial Lifetime Technology (soft and fast recovery)
- <sup>3)</sup> With integrated DC and AC shunts
- <sup>4)</sup> accuracy of pure shunt, please note that for DC shunt no separate sensing contact is used.

Characteristics		min.	typ.	max.	Units
Symbol	Conditions <sup>1)</sup>				
IGBT - Inverter & Chopper					
V <sub>CEsat</sub>	I <sub>C</sub> = 20 A T <sub>J</sub> = 25 (125) °C	-	2,1(2,4)	2,6(2,9)	V
t <sub>d(on)</sub>	V <sub>CC</sub> = 300 V; V <sub>GE</sub> = ± 15 V	-	30	-	ns
t <sub>r</sub>	I <sub>C</sub> = 20 A; T <sub>J</sub> = 125 °C	-	35	-	ns
t <sub>d(off)</sub>	R <sub>gon</sub> = R <sub>goff</sub> = 47 Ω	-	200	-	ns
t <sub>f</sub>	inductive load	-	25	-	ns
E <sub>on</sub> + E <sub>off</sub>		-	1,7	-	mJ
C <sub>ies</sub>	V <sub>CE</sub> = 25 V; V <sub>GE</sub> = 0 V, 1 MHz	-	1,1	-	nF
R <sub>thjh</sub>	per IGBT	-	-	1,7	K/W
Diode <sup>2)</sup> - Inverter & Chopper					
V <sub>F</sub> = V <sub>EC</sub>	I <sub>F</sub> = 25 A T <sub>J</sub> = 25 (125) °C	-	1,45(1,4)	1,7(1,75)	V
V <sub>TO</sub>	T <sub>J</sub> = 125 °C	-	0,85	0,9	V
r <sub>T</sub>	T <sub>J</sub> = 125 °C	-	22	32	mΩ
I <sub>R<sub>RM</sub></sub>	I <sub>F</sub> = 25 A, V <sub>R</sub> = - 300 V	-	16	-	A
Q <sub>rr</sub>	di <sub>F</sub> /dt = - 500 A/μs	-	2	-	μC
E <sub>off</sub>	V <sub>GE</sub> = 0 V, T <sub>J</sub> = 125 °C	-	0,25	-	mJ
R <sub>thjh</sub>	per diode	-	-	1,7	K/W
Diode - Rectifier					
V <sub>F</sub>	I <sub>F</sub> = 25 A T <sub>J</sub> = 25 °C	-	1,2	-	V
R <sub>thjh</sub>	per diode	-	-	1,7	K/W
Temperature Sensor					
R <sub>TS</sub>	T = 25 / 100 °C		1000 / 1670		Ω
Shunts (SKiiP 21 NAB 063 I T1)					
R <sub>cs(dc)</sub>	5 % <sup>4)</sup>		16,5		mΩ
R <sub>cs(ac)</sub>	1 %		10		mΩ
Mechanical Data					
M <sub>1</sub>	Mounting torque	2	-	2,5	Nm
Case			M2		

This technical information specifies semiconductor devices but promises no characteristics. No warranty or guarantee expressed or implied is made regarding delivery, performance or suitability.

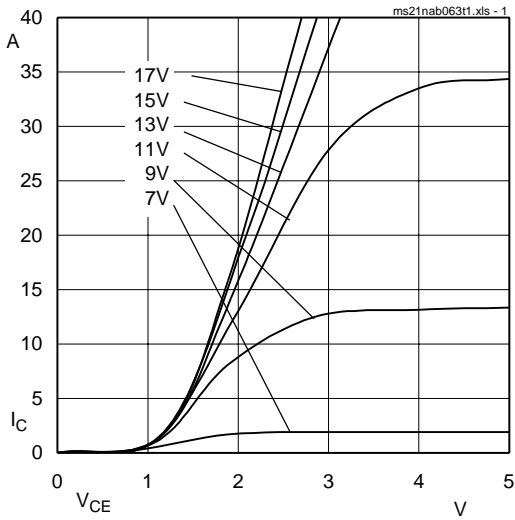

Fig. 1 Typ. output characteristic,  $t_p = 80 \mu s$ ;  $25 \text{ }^\circ\text{C}$

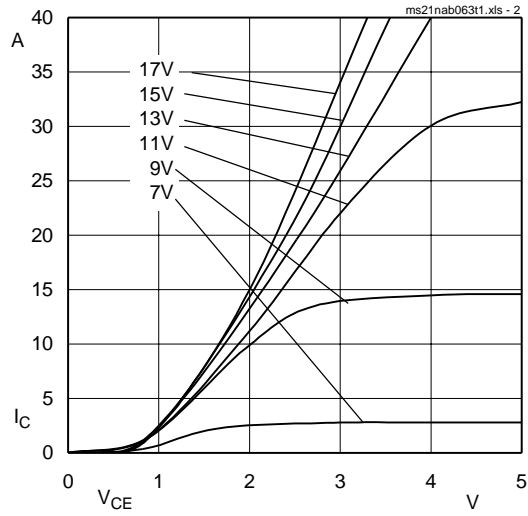

Fig. 2 Typ. output characteristic,  $t_p = 80 \mu s$ ;  $125 \text{ }^\circ\text{C}$

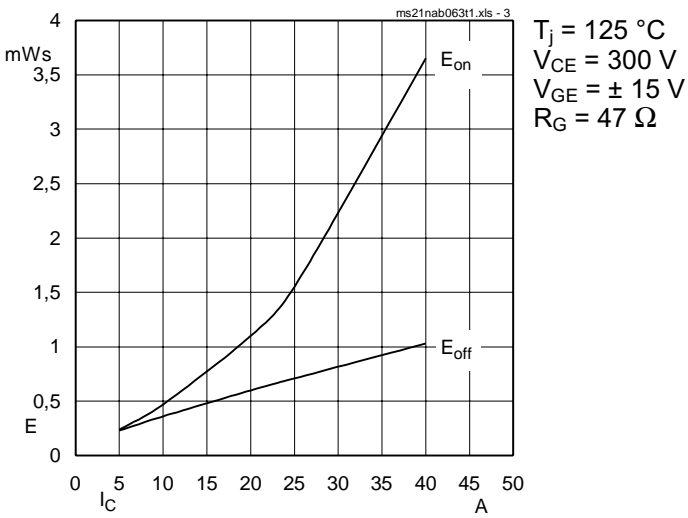

Fig. 3 Turn-on /-off energy =  $f(I_c)$

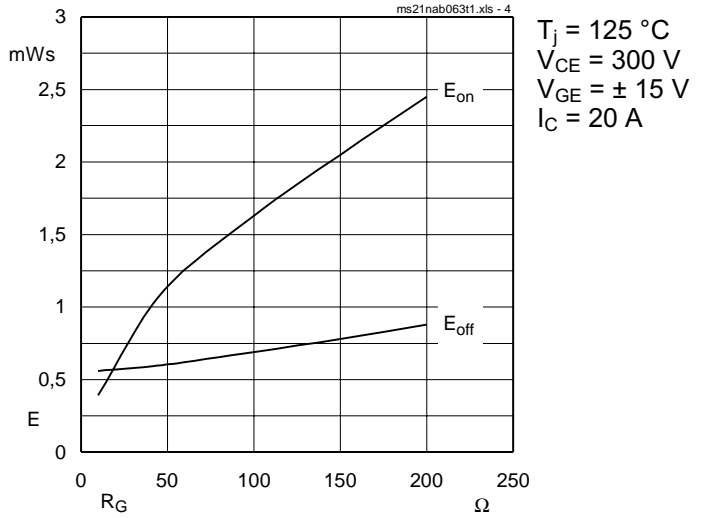

Fig. 4 Turn-on /-off energy =  $f(R_G)$

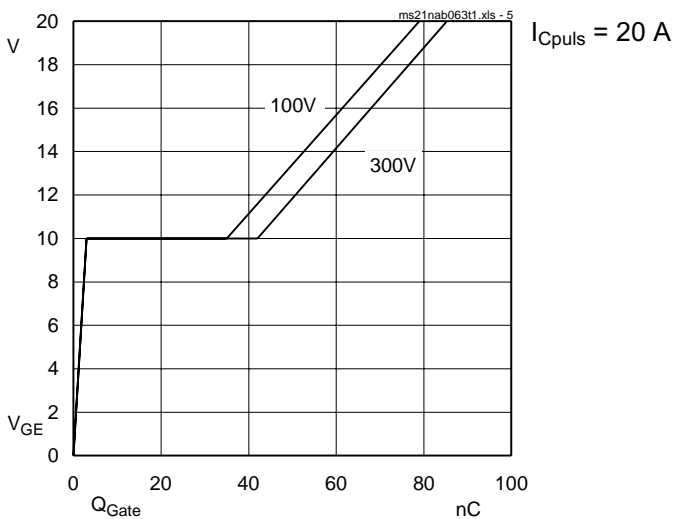

Fig. 5 Typ. gate charge characteristic

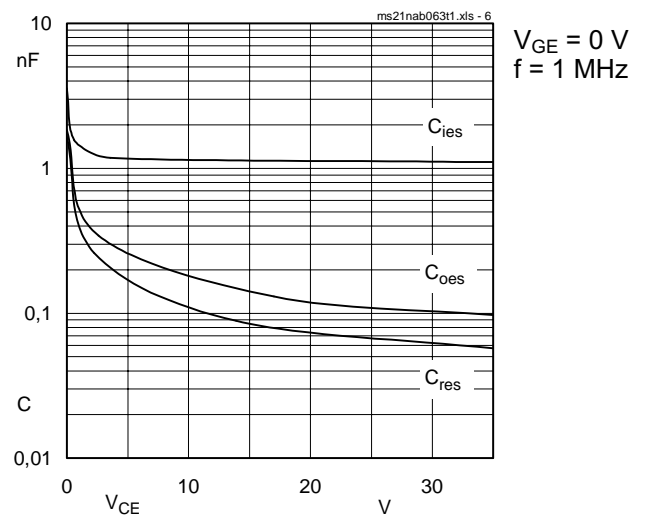

Fig. 6 Typ. capacitances vs.  $V_{CE}$

## 2. Common characteristics of MiniSKiiP

### MiniSKiiP 600 V

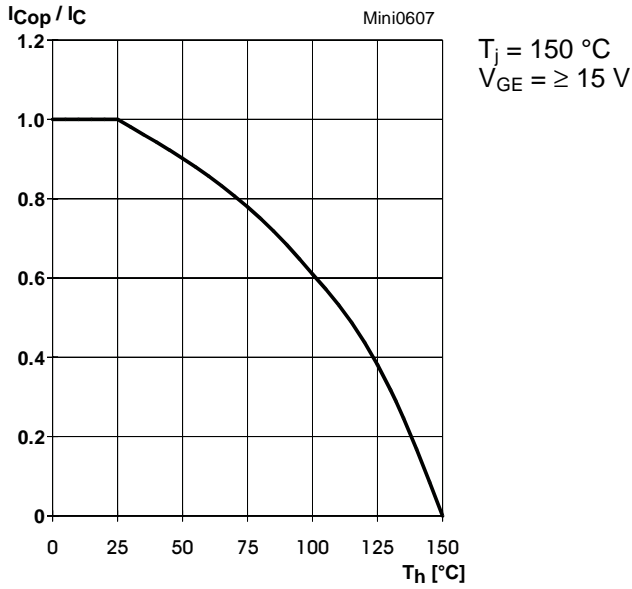

Fig. 7 Rated current of the IGBT  $I_{COP} / I_C = f(T_h)$

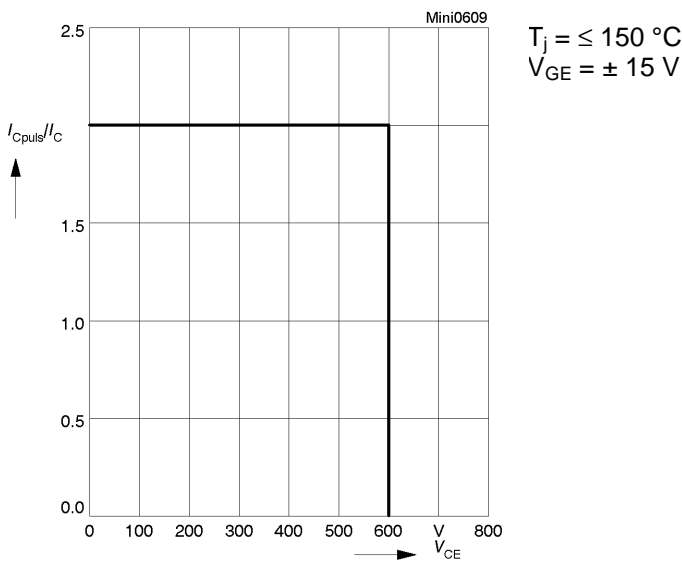

Fig. 9 Turn-off safe operating area (RBSOA) of the IGBT

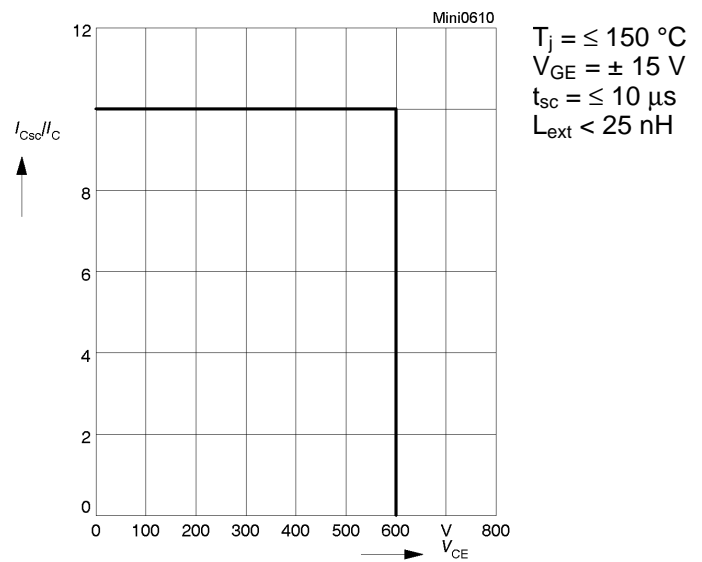

Fig. 10 Safe operating area at short circuit of the IGBT

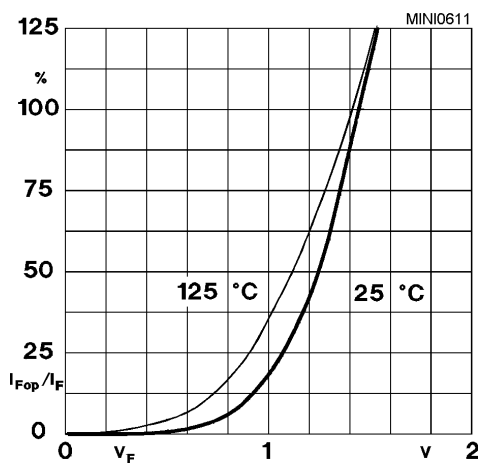

Fig. 11 Typ. freewheeling diode forward characteristic

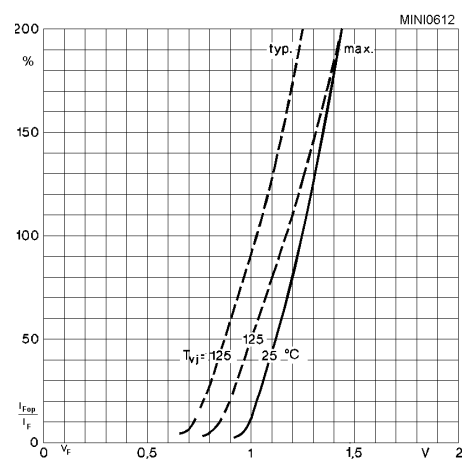
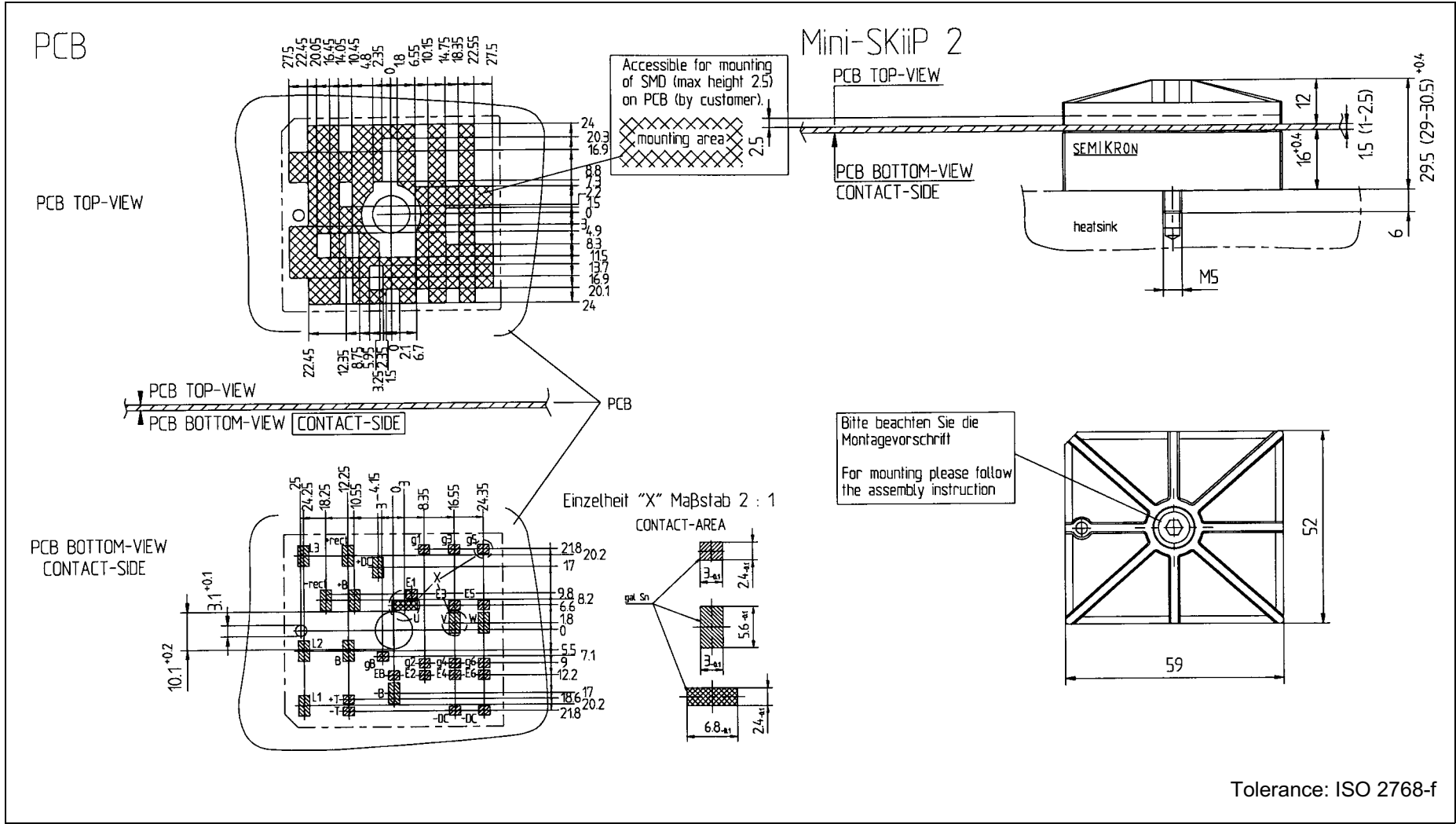
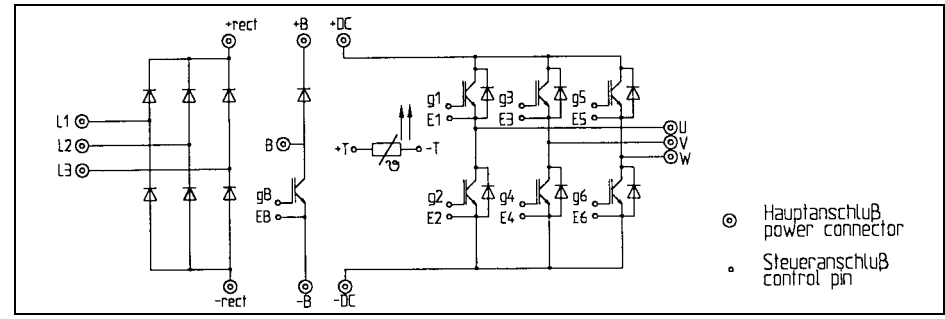

Fig. 12 Forward characteristic of the input bridge diode

# MiniSKiiP 2

SKiiP 21 NAB 063 T1  
SKiiP 22 NAB 063 T1



**MiniSKiiP 2**

SKiiP 21 NAB 063 I T1

