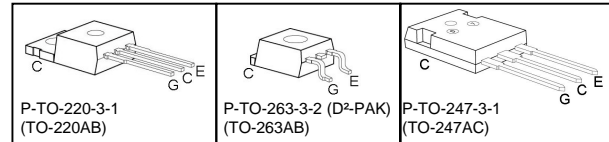
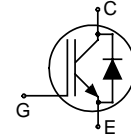


## Fast IGBT in NPT-technology with soft, fast recovery anti-parallel EmCon diode

- 75% lower  $E_{off}$  compared to previous generation combined with low conduction losses
- Short circuit withstand time – 10  $\mu$ s
- Designed for:
  - Motor controls
  - Inverter
- NPT-Technology for 600V applications offers:
  - very tight parameter distribution
  - high ruggedness, temperature stable behaviour
  - parallel switching capability
- Very soft, fast recovery anti-parallel EmCon diode



- Complete product spectrum and PSpice Models : <http://www.infineon.com/igbt/>

Type	$V_{CE}$	$I_C$	$V_{CE(sat)}$	$T_j$	Package	Ordering Code
SKP15N60	600V	15A	2.3V	150°C	TO-220AB	Q67040-S4251
SKB15N60					TO-263AB	Q67040-S4252
SKW15N60					TO-247AC	Q67040-S4243

### Maximum Ratings

Parameter	Symbol	Value	Unit
Collector-emitter voltage	$V_{CE}$	600	V
DC collector current	$I_C$	31	A
$T_C = 25^\circ\text{C}$		31	
$T_C = 100^\circ\text{C}$		15	
Pulsed collector current, $t_p$ limited by $T_{jmax}$	$I_{Cpuls}$	62	
Turn off safe operating area	-	62	
$V_{CE} \leq 600\text{V}, T_j \leq 150^\circ\text{C}$			
Diode forward current	$I_F$	31	
$T_C = 25^\circ\text{C}$		31	
$T_C = 100^\circ\text{C}$		15	
Diode pulsed current, $t_p$ limited by $T_{jmax}$	$I_{Fpuls}$	62	
Gate-emitter voltage	$V_{GE}$	$\pm 20$	V
Short circuit withstand time <sup>1)</sup>	$t_{SC}$	10	$\mu$ s
$V_{GE} = 15\text{V}, V_{CC} \leq 600\text{V}, T_j \leq 150^\circ\text{C}$			
Power dissipation	$P_{tot}$	139	W
$T_C = 25^\circ\text{C}$			
Operating junction and storage temperature	$T_j, T_{stg}$	-55...+150	°C

<sup>1)</sup> Allowed number of short circuits: <1000; time between short circuits: >1s.

## Thermal Resistance

Parameter	Symbol	Conditions	Max. Value	Unit
<b>Characteristic</b>				
IGBT thermal resistance, junction – case	$R_{thJC}$		0.9	K/W
Diode thermal resistance, junction – case	$R_{thJCD}$		1.7	
Thermal resistance, junction – ambient	$R_{thJA}$	TO-220AB	62	
		TO-247AC	40	
SMD version, device on PCB <sup>1)</sup>	$R_{thJA}$	TO-263AB	40	

## Electrical Characteristic, at $T_j = 25\text{ }^\circ\text{C}$ , unless otherwise specified

Parameter	Symbol	Conditions	Value			Unit
			min.	Typ.	max.	
<b>Static Characteristic</b>						
Collector-emitter breakdown voltage	$V_{(BR)CES}$	$V_{GE}=0V, I_C=500\mu A$	600	-	-	V
Collector-emitter saturation voltage	$V_{CE(sat)}$	$V_{GE} = 15V, I_C=15A$ $T_j=25\text{ }^\circ\text{C}$ $T_j=150\text{ }^\circ\text{C}$	1.7 -	2 2.3	2.4 2.8	
Diode forward voltage	$V_F$	$V_{GE}=0V, I_F=15A$ $T_j=25\text{ }^\circ\text{C}$ $T_j=150\text{ }^\circ\text{C}$	1.2 -	1.4 1.25	1.8 1.65	
Gate-emitter threshold voltage	$V_{GE(th)}$	$I_C=400\mu A, V_{CE}=V_{GE}$	3	4	5	
Zero gate voltage collector current	$I_{CES}$	$V_{CE}=600V, V_{GE}=0V$ $T_j=25\text{ }^\circ\text{C}$ $T_j=150\text{ }^\circ\text{C}$	- -	- -	40 2000	$\mu A$
Gate-emitter leakage current	$I_{GES}$	$V_{CE}=0V, V_{GE}=20V$	-	-	100	nA
Transconductance	$g_{fs}$	$V_{CE}=20V, I_C=15A$	3	10.9	-	S
<b>Dynamic Characteristic</b>						
Input capacitance	$C_{iss}$	$V_{CE}=25V,$ $V_{GE}=0V,$ $f=1\text{MHz}$	-	800	960	pF
Output capacitance	$C_{oss}$		-	84	101	
Reverse transfer capacitance	$C_{rfs}$		-	52	62	
Gate charge	$Q_{Gate}$	$V_{CC}=480V, I_C=15A$ $V_{GE}=15V$	-	76	99	nC
Internal emitter inductance measured 5mm (0.197 in.) from case	$L_E$	TO-220AB	-	7	-	nH
		TO-247AC	-	13	-	
Short circuit collector current <sup>2)</sup>	$I_{C(SC)}$	$V_{GE}=15V, t_{SC}\leq 10\mu s$ $V_{CC}\leq 600V,$ $T_j\leq 150\text{ }^\circ\text{C}$	-	150	-	A

<sup>1)</sup> Device on 50mm\*50mm\*1.5mm epoxy PCB FR4 with 6cm<sup>2</sup> (one layer, 70μm thick) copper area for collector connection. PCB is vertical without blown air.

<sup>2)</sup> Allowed number of short circuits: <1000; time between short circuits: >1s.

### Switching Characteristic, Inductive Load, at $T_j=25^\circ\text{C}$

Parameter	Symbol	Conditions	Value			Unit
			min.	typ.	max.	
<b>IGBT Characteristic</b>						
Turn-on delay time	$t_{d(on)}$	$T_j=25^\circ\text{C}$ , $V_{CC}=400\text{V}$ , $I_C=15\text{A}$ , $V_{GE}=0/15\text{V}$ , $R_G=21\Omega$ , $L_{\sigma}^{(1)}=180\text{nH}$ , $C_{\sigma}^{(1)}=250\text{pF}$ Energy losses include "tail" and diode reverse recovery.	-	32	38	ns
Rise time	$t_r$		-	23	28	
Turn-off delay time	$t_{d(off)}$		-	234	281	
Fall time	$t_f$		-	46	55	
Turn-on energy	$E_{on}$		-	0.30	0.36	mJ
Turn-off energy	$E_{off}$		-	0.27	0.35	
Total switching energy	$E_{ts}$		-	0.57	0.71	

### Anti-Parallel Diode Characteristic

Diode reverse recovery time	$t_{rr}$	$T_j=25^\circ\text{C}$ , $V_R=200\text{V}$ , $I_F=15\text{A}$ , $di_F/dt=200\text{A}/\mu\text{s}$	-	279	-	ns
	$t_S$		-	28	-	
	$t_F$		-	254	-	
Diode reverse recovery charge	$Q_{rr}$		-	390	-	nC
Diode peak reverse recovery current	$I_{rrm}$		-	5.0	-	A
Diode peak rate of fall of reverse recovery current during $t_b$	$di_{rr}/dt$	-	180	-	A/ $\mu\text{s}$	

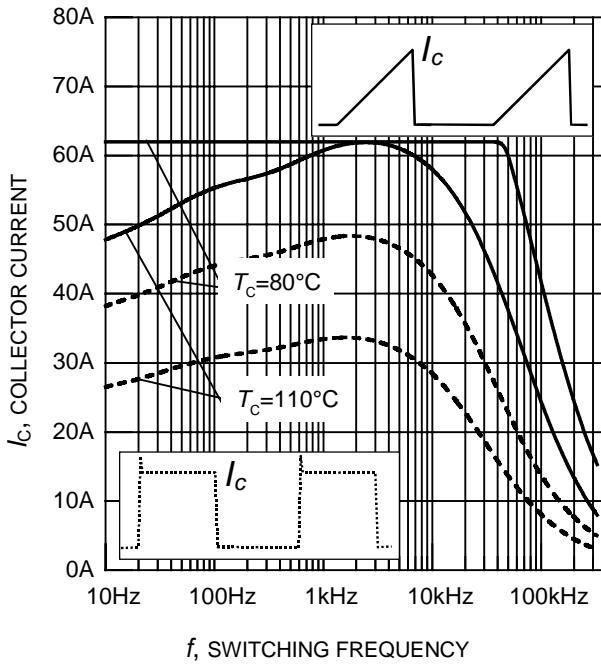
### Switching Characteristic, Inductive Load, at $T_j=150^\circ\text{C}$

Parameter	Symbol	Conditions	Value			Unit
			min.	typ.	max.	
<b>IGBT Characteristic</b>						
Turn-on delay time	$t_{d(on)}$	$T_j=150^\circ\text{C}$ $V_{CC}=400\text{V}$ , $I_C=15\text{A}$ , $V_{GE}=0/15\text{V}$ , $R_G=21\Omega$ , $L_{\sigma}^{(1)}=180\text{nH}$ , $C_{\sigma}^{(1)}=250\text{pF}$ Energy losses include "tail" and diode reverse recovery.	-	31	38	ns
Rise time	$t_r$		-	23	28	
Turn-off delay time	$t_{d(off)}$		-	261	313	
Fall time	$t_f$		-	54	65	
Turn-on energy	$E_{on}$		-	0.45	0.54	mJ
Turn-off energy	$E_{off}$		-	0.41	0.53	
Total switching energy	$E_{ts}$		-	0.86	1.07	

### Anti-Parallel Diode Characteristic

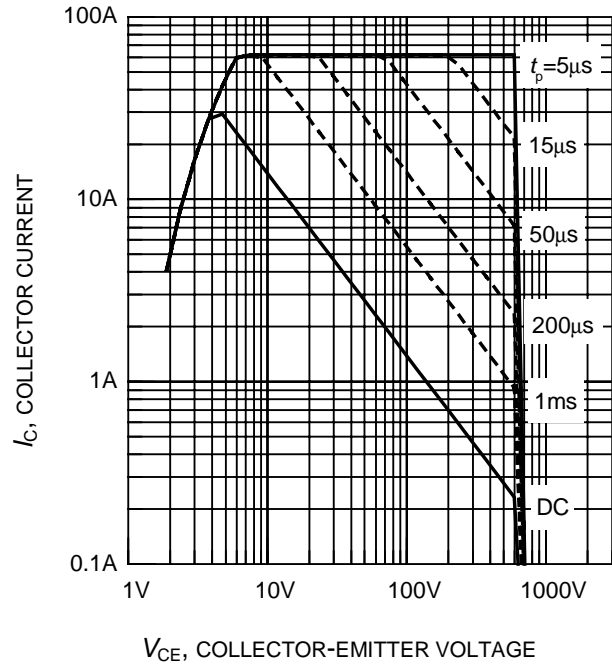
Diode reverse recovery time	$t_{rr}$	$T_j=150^\circ\text{C}$ $V_R=200\text{V}$ , $I_F=15\text{A}$ , $di_F/dt=200\text{A}/\mu\text{s}$	-	360	-	ns
	$t_S$		-	40	-	
	$t_F$		-	320	-	
Diode reverse recovery charge	$Q_{rr}$		-	1020	-	nC
Diode peak reverse recovery current	$I_{rrm}$		-	7.5	-	A
Diode peak rate of fall of reverse recovery current during $t_b$	$di_{rr}/dt$	-	200	-	A/ $\mu\text{s}$	

<sup>1)</sup> Leakage inductance  $L_{\sigma}$  and Stray capacity  $C_{\sigma}$  due to dynamic test circuit in Figure E.



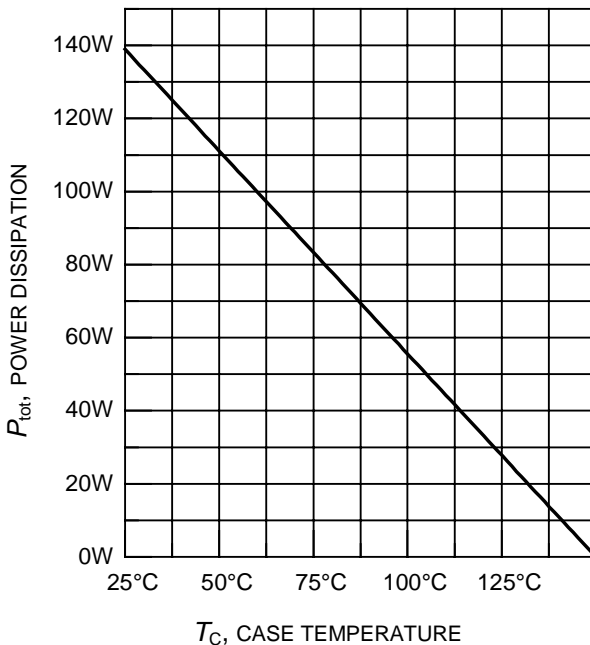
**Figure 1. Collector current as a function of switching frequency**

( $T_j \leq 150^\circ\text{C}$ ,  $D = 0.5$ ,  $V_{CE} = 400\text{V}$ ,  
 $V_{GE} = 0/+15\text{V}$ ,  $R_G = 21\Omega$ )



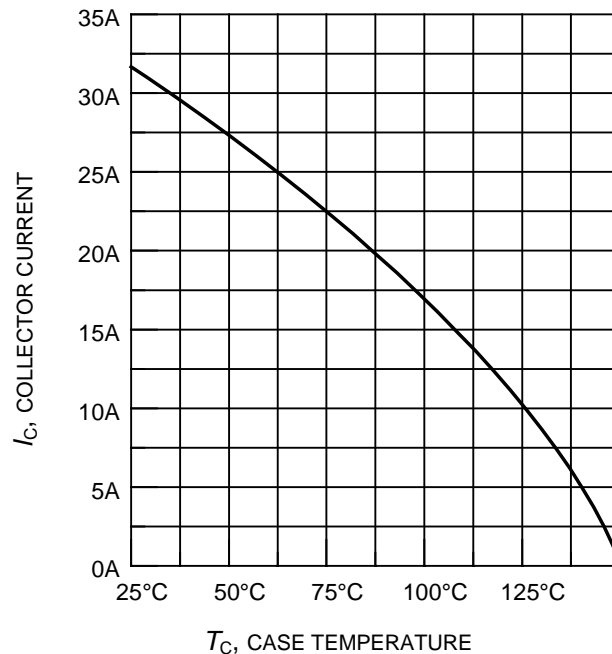
**Figure 2. Safe operating area**

( $D = 0$ ,  $T_C = 25^\circ\text{C}$ ,  $T_j \leq 150^\circ\text{C}$ )



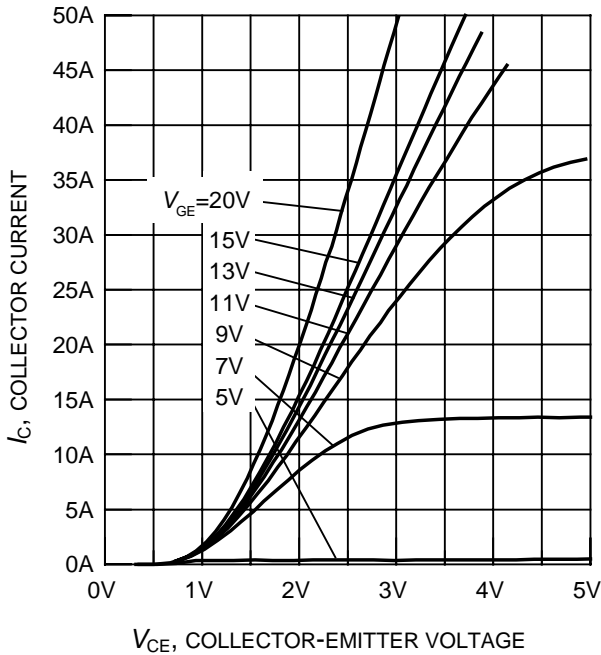
**Figure 3. Power dissipation as a function of case temperature**

( $T_j \leq 150^\circ\text{C}$ )

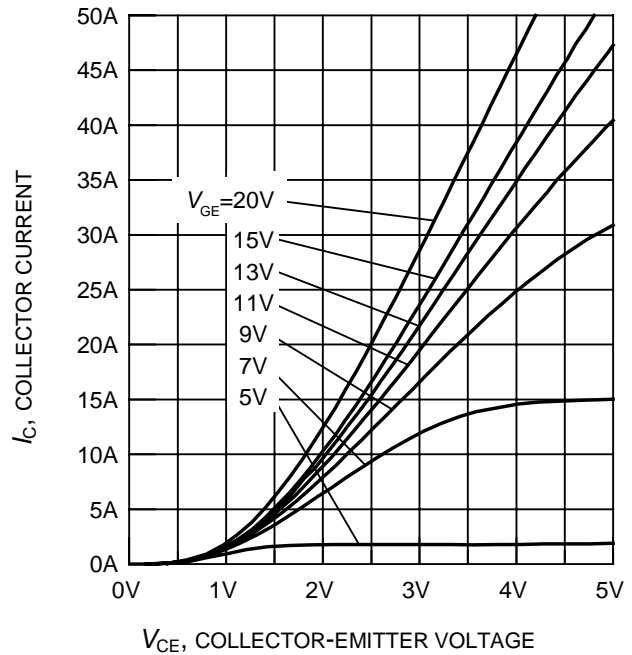


**Figure 4. Collector current as a function of case temperature**

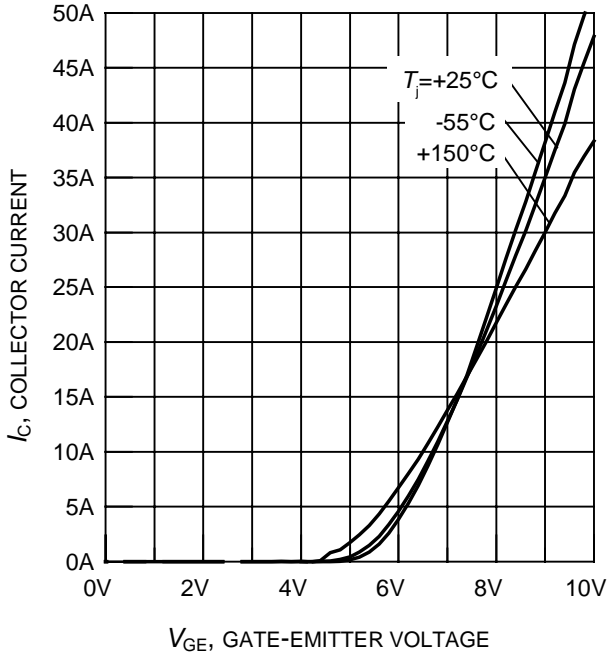
( $V_{GE} \leq 15\text{V}$ ,  $T_j \leq 150^\circ\text{C}$ )



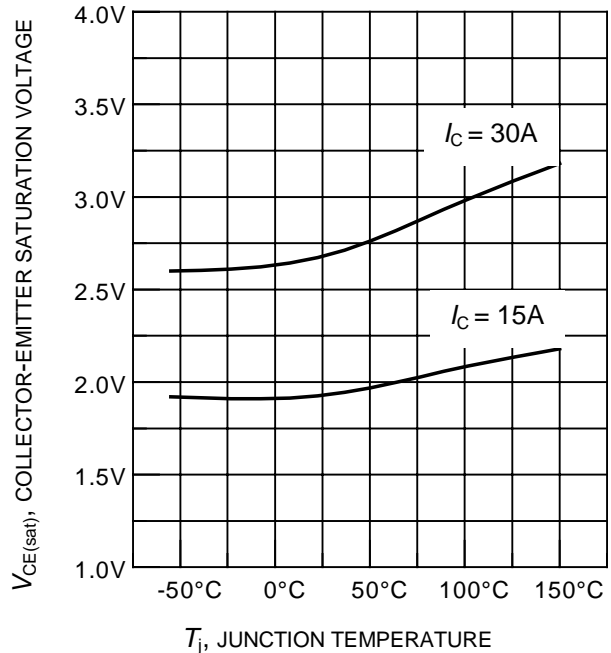
**Figure 5. Typical output characteristics**  
( $T_j = 25^\circ\text{C}$ )



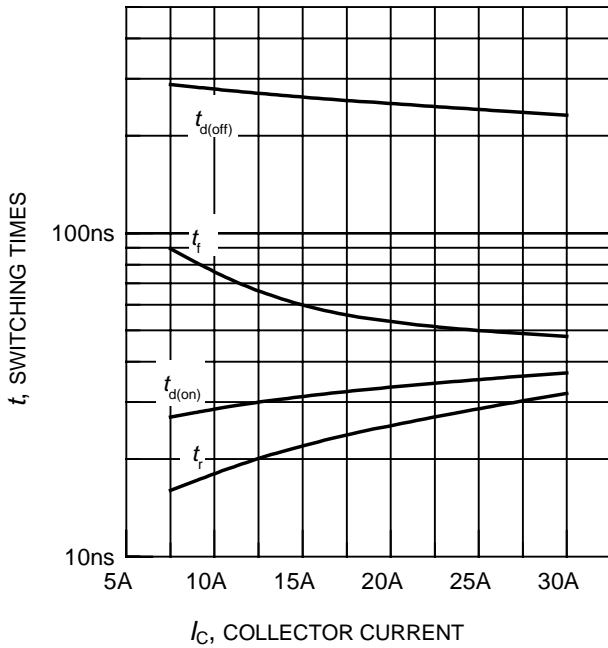
**Figure 6. Typical output characteristics**  
( $T_j = 150^\circ\text{C}$ )



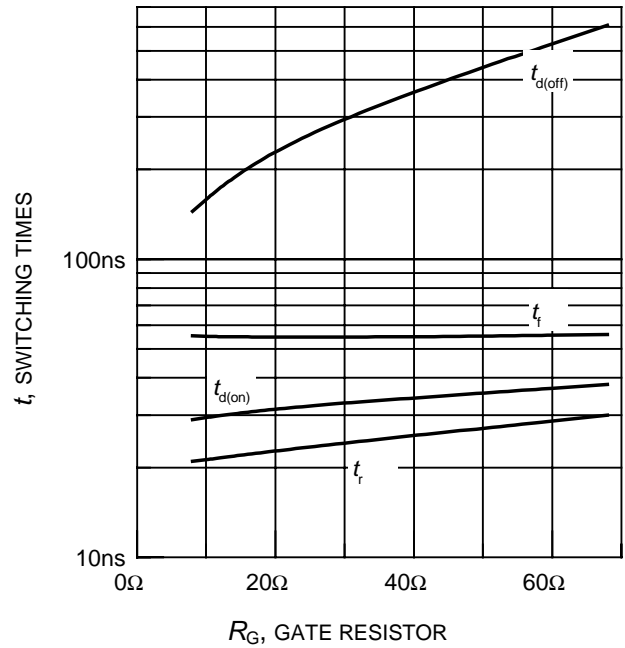
**Figure 7. Typical transfer characteristics**  
( $V_{CE} = 10\text{V}$ )



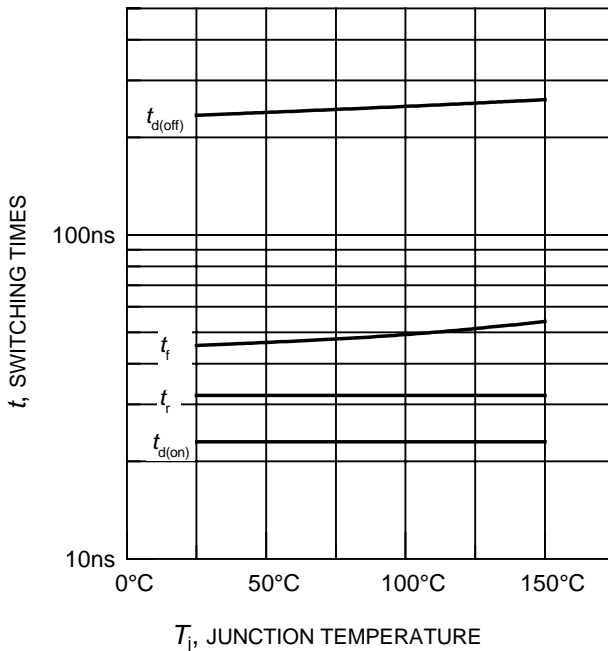
**Figure 8. Typical collector-emitter saturation voltage as a function of junction temperature**  
( $V_{GE} = 15\text{V}$ )



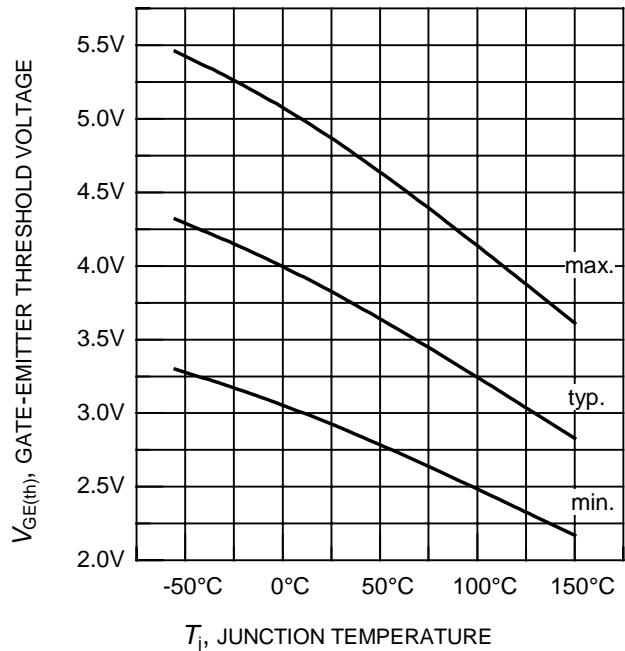
**Figure 9. Typical switching times as a function of collector current**  
(inductive load,  $T_j = 150^\circ\text{C}$ ,  $V_{CE} = 400\text{V}$ ,  $V_{GE} = 0/+15\text{V}$ ,  $R_G = 21\Omega$ , Dynamic test circuit in Figure E)



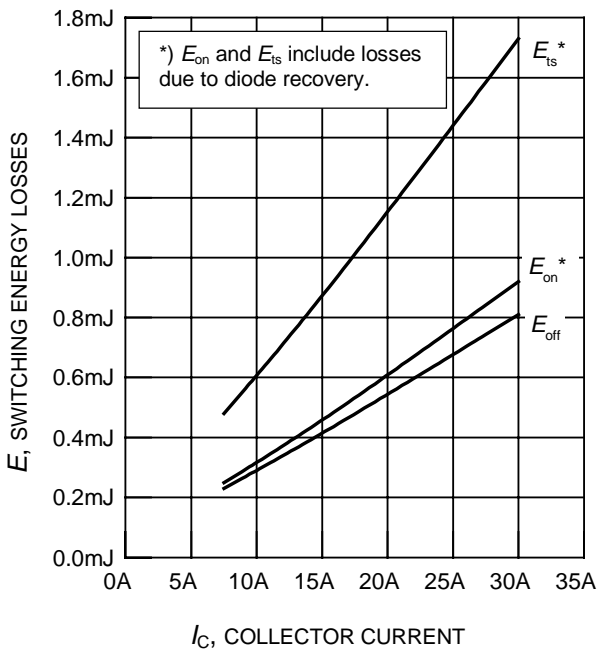
**Figure 10. Typical switching times as a function of gate resistor**  
(inductive load,  $T_j = 150^\circ\text{C}$ ,  $V_{CE} = 400\text{V}$ ,  $V_{GE} = 0/+15\text{V}$ ,  $I_C = 15\text{A}$ , Dynamic test circuit in Figure E)



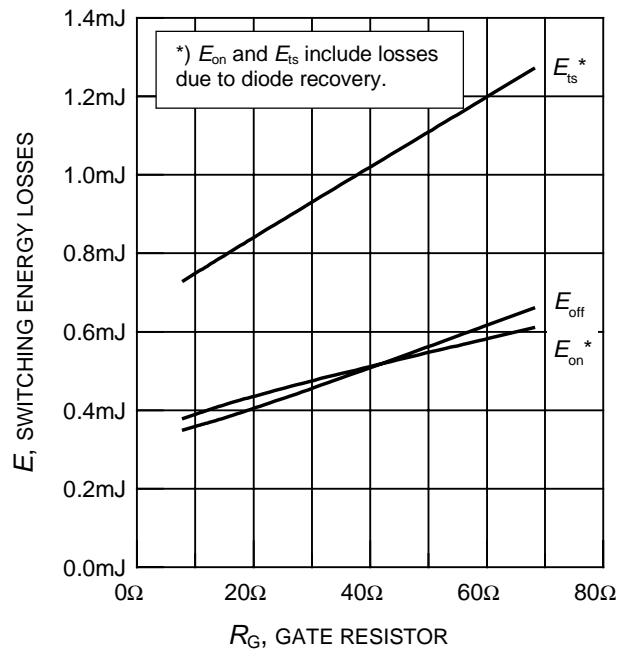
**Figure 11. Typical switching times as a function of junction temperature**  
(inductive load,  $V_{CE} = 400\text{V}$ ,  $V_{GE} = 0/+15\text{V}$ ,  $I_C = 15\text{A}$ ,  $R_G = 21\Omega$ , Dynamic test circuit in Figure E)



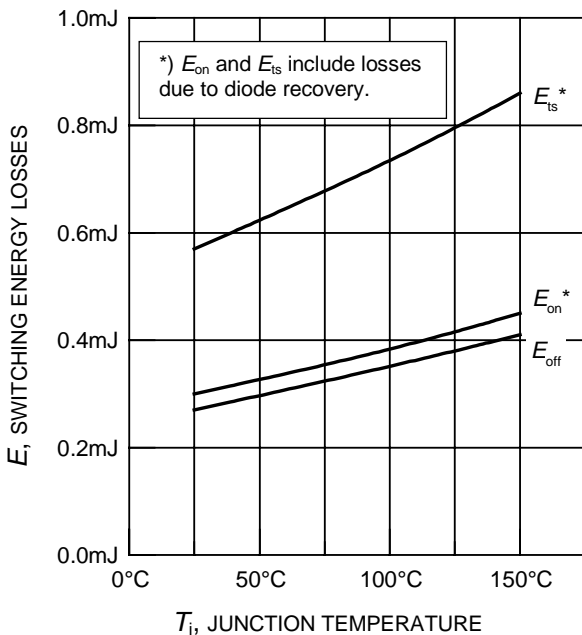
**Figure 12. Gate-emitter threshold voltage as a function of junction temperature**  
( $I_C = 0.4\text{mA}$ )



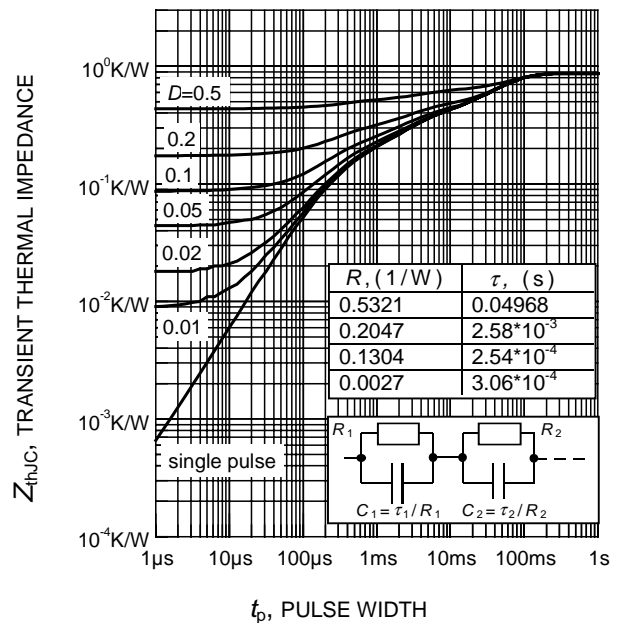
**Figure 13. Typical switching energy losses as a function of collector current**  
(inductive load,  $T_j = 150^\circ\text{C}$ ,  $V_{CE} = 400\text{V}$ ,  $V_{GE} = 0/+15\text{V}$ ,  $R_G = 21\Omega$ , Dynamic test circuit in Figure E)



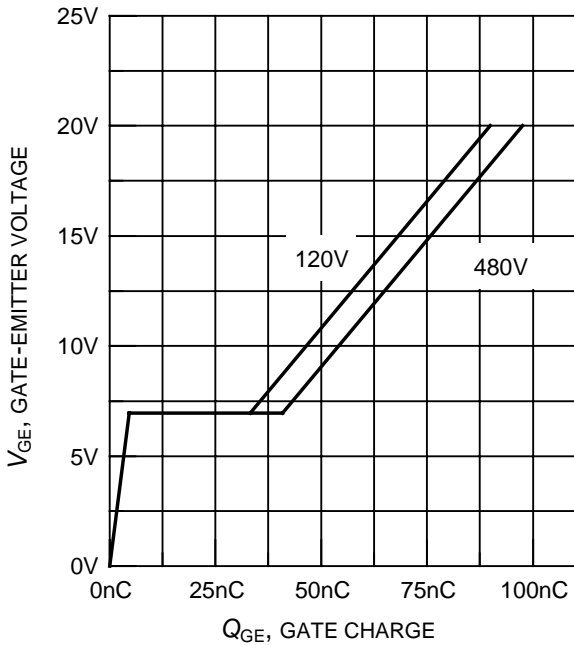
**Figure 14. Typical switching energy losses as a function of gate resistor**  
(inductive load,  $T_j = 150^\circ\text{C}$ ,  $V_{CE} = 400\text{V}$ ,  $V_{GE} = 0/+15\text{V}$ ,  $I_C = 15\text{A}$ , Dynamic test circuit in Figure E)



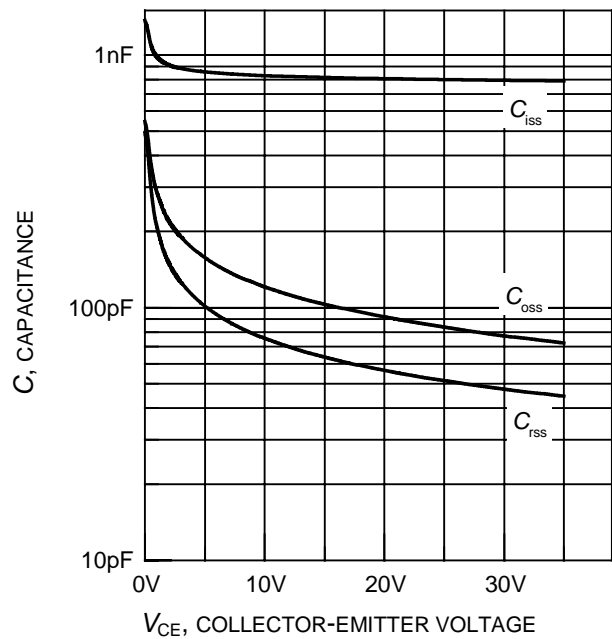
**Figure 15. Typical switching energy losses as a function of junction temperature**  
(inductive load,  $V_{CE} = 400\text{V}$ ,  $V_{GE} = 0/+15\text{V}$ ,  $I_C = 15\text{A}$ ,  $R_G = 21\Omega$ , Dynamic test circuit in Figure E)



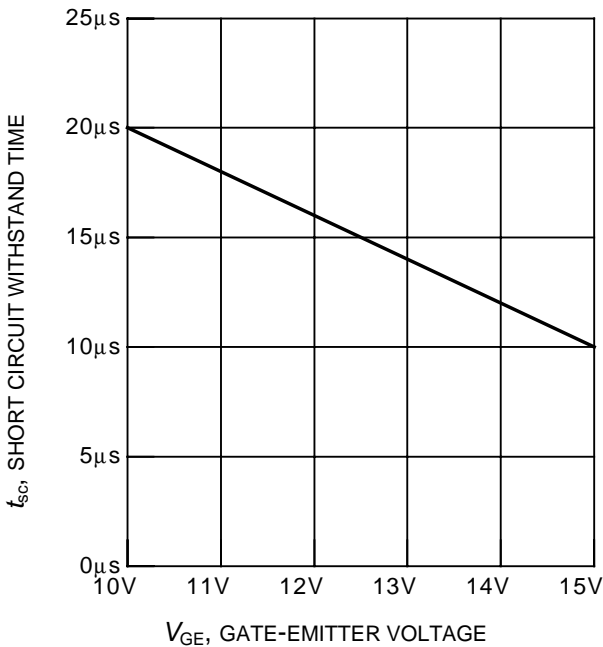
**Figure 16. IGBT transient thermal impedance as a function of pulse width**  
( $D = t_p / T$ )



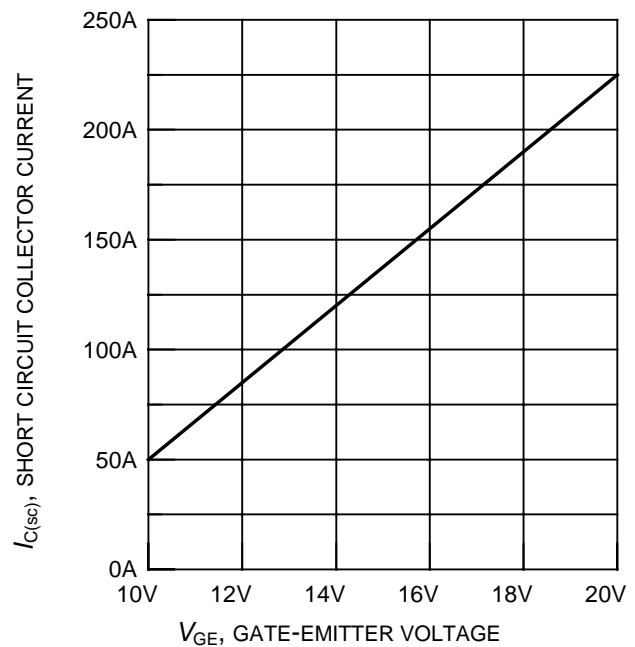
**Figure 17. Typical gate charge**  
( $I_C = 15A$ )



**Figure 18. Typical capacitance as a function of collector-emitter voltage**  
( $V_{GE} = 0V, f = 1MHz$ )

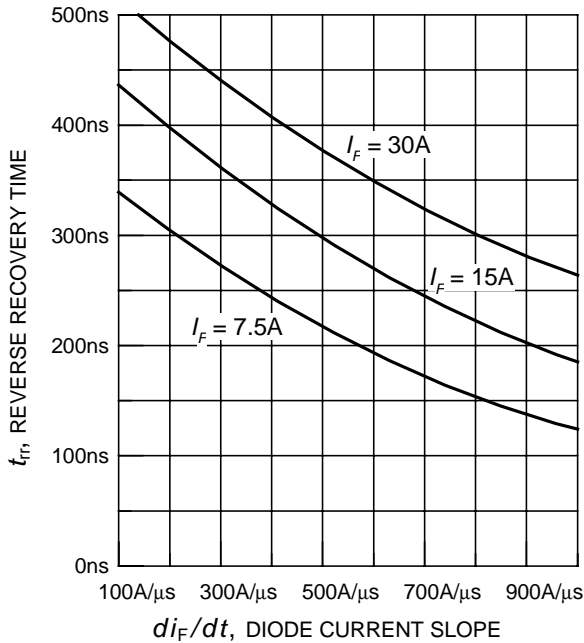


**Figure 19. Short circuit withstand time as a function of gate-emitter voltage**  
( $V_{CE} = 600V$ , start at  $T_j = 25^\circ C$ )

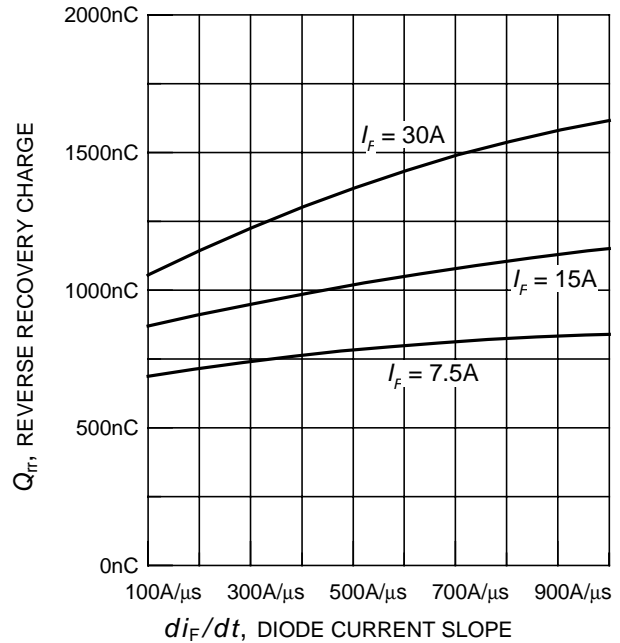


**Figure 20. Typical short circuit collector current as a function of gate-emitter voltage**  
( $V_{CE} \leq 600V, T_j = 150^\circ C$ )

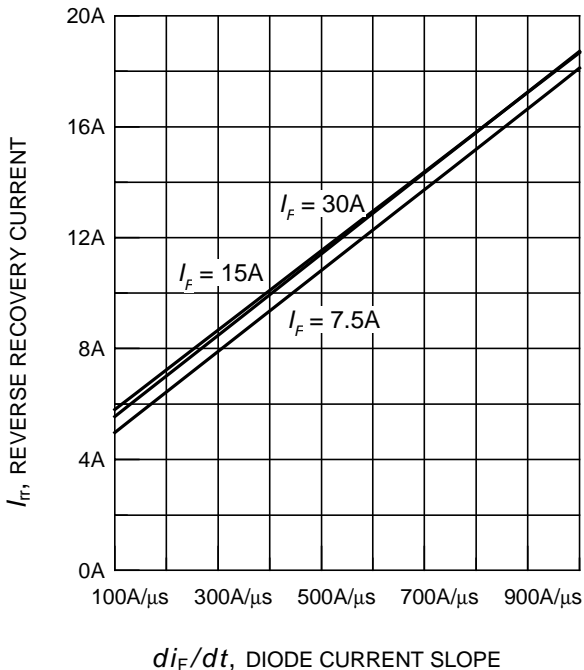




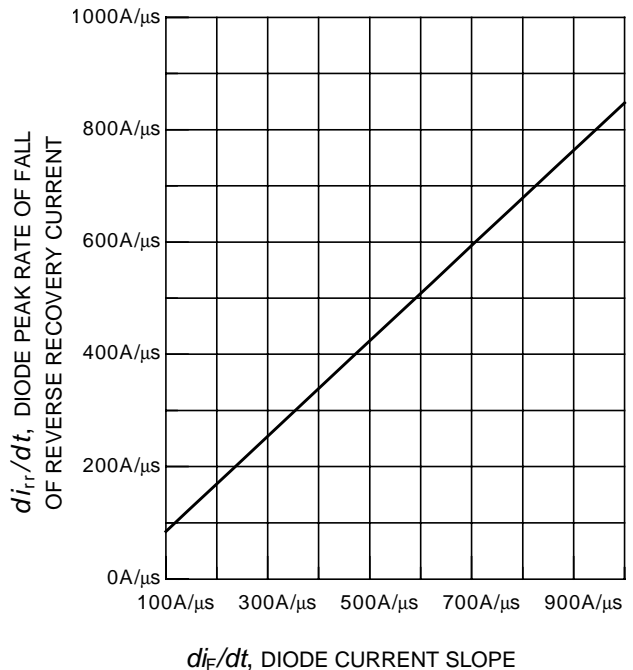
**Figure 21. Typical reverse recovery time as a function of diode current slope**  
( $V_R = 200V$ ,  $T_j = 125^\circ C$ ,  
Dynamic test circuit in Figure E)



**Figure 22. Typical reverse recovery charge as a function of diode current slope**  
( $V_R = 200V$ ,  $T_j = 125^\circ C$ ,  
Dynamic test circuit in Figure E)



**Figure 23. Typical reverse recovery current as a function of diode current slope**  
( $V_R = 200V$ ,  $T_j = 125^\circ C$ ,  
Dynamic test circuit in Figure E)



**Figure 24. Typical diode peak rate of fall of reverse recovery current as a function of diode current slope**  
( $V_R = 200V$ ,  $T_j = 125^\circ C$ ,  
Dynamic test circuit in Figure E)

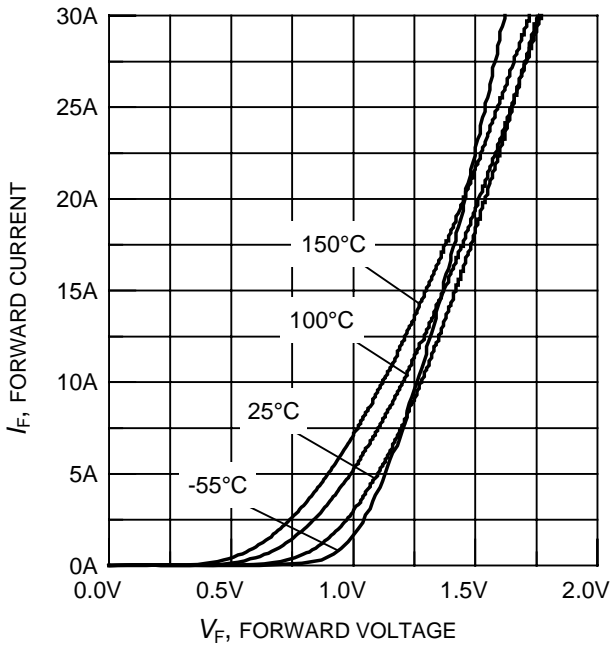


Figure 25. Typical diode forward current as a function of forward voltage

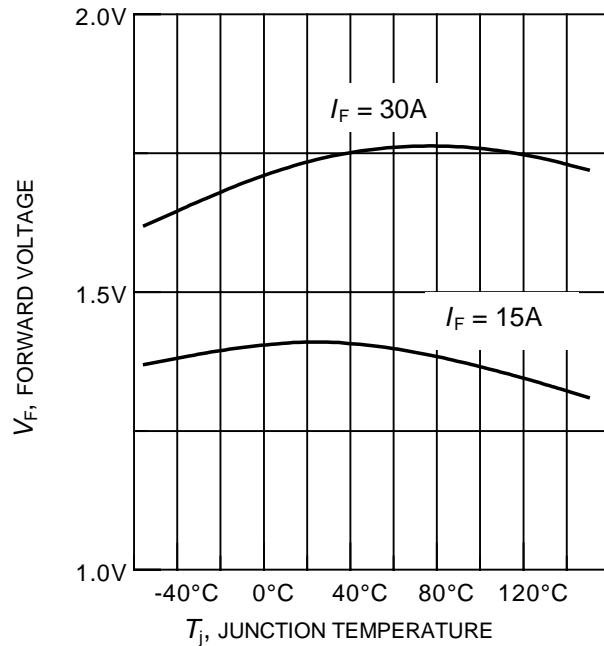


Figure 26. Typical diode forward voltage as a function of junction temperature

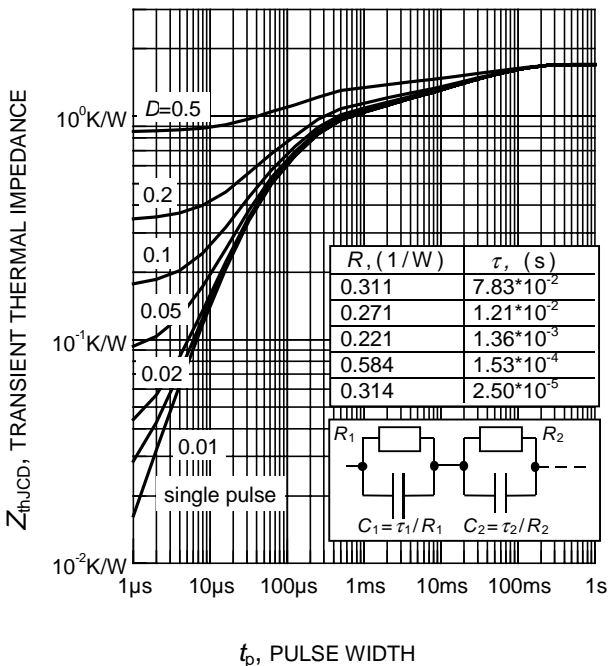
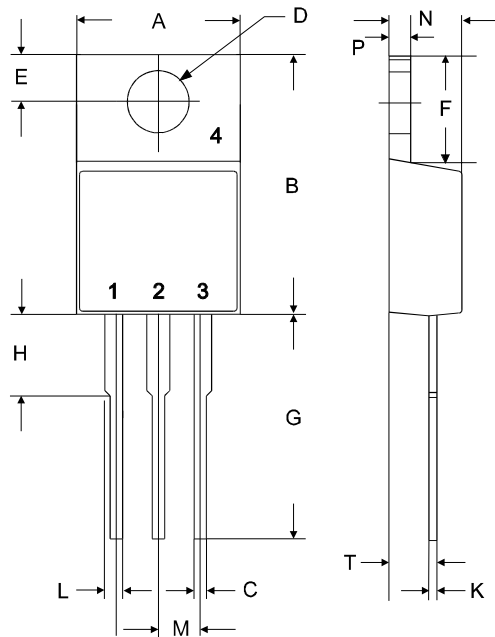


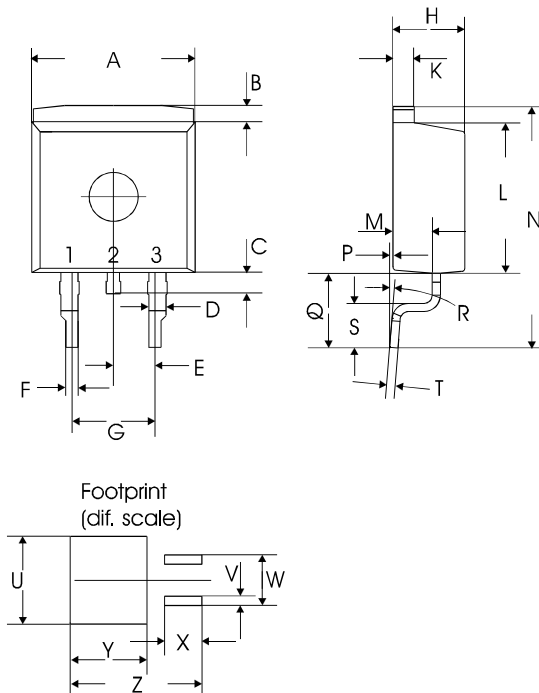
Figure 27. Diode transient thermal impedance as a function of pulse width ( $D = t_p / T$ )

TO-220AB

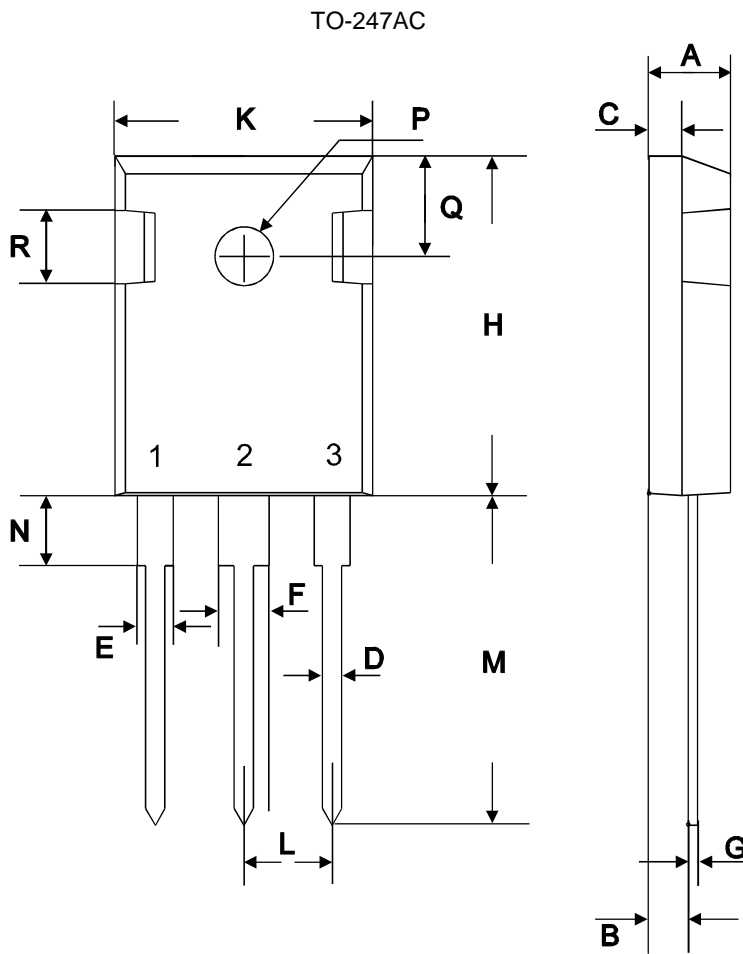


symbol	dimensions			
	[mm]		[inch]	
	min	max	min	max
A	9.70	10.30	0.3819	0.4055
B	14.88	15.95	0.5858	0.6280
C	0.65	0.86	0.0256	0.0339
D	3.55	3.89	0.1398	0.1531
E	2.60	3.00	0.1024	0.1181
F	6.00	6.80	0.2362	0.2677
G	13.00	14.00	0.5118	0.5512
H	4.35	4.75	0.1713	0.1870
K	0.38	0.65	0.0150	0.0256
L	0.95	1.32	0.0374	0.0520
M	2.54 typ.		0.1 typ.	
N	4.30	4.50	0.1693	0.1772
P	1.17	1.40	0.0461	0.0551
T	2.30	2.72	0.0906	0.1071

TO-263AB (D<sup>2</sup>Pak)



symbol	dimensions			
	[mm]		[inch]	
	min	max	min	max
A	9.80	10.20	0.3858	0.4016
B	0.70	1.30	0.0276	0.0512
C	1.00	1.60	0.0394	0.0630
D	1.03	1.07	0.0406	0.0421
E	2.54 typ.		0.1 typ.	
F	0.65	0.85	0.0256	0.0335
G	5.08 typ.		0.2 typ.	
H	4.30	4.50	0.1693	0.1772
K	1.17	1.37	0.0461	0.0539
L	9.05	9.45	0.3563	0.3720
M	2.30	2.50	0.0906	0.0984
N	15 typ.		0.5906 typ.	
P	0.00	0.20	0.0000	0.0079
Q	4.20	5.20	0.1654	0.2047
R	8° max		8° max	
S	2.40	3.00	0.0945	0.1181
T	0.40	0.60	0.0157	0.0236
U	10.80		0.4252	
V	1.15		0.0453	
W	6.23		0.2453	
X	4.60		0.1811	
Y	9.40		0.3701	
Z	16.15		0.6358	



symbol	dimensions			
	[mm]		[inch]	
	min	max	min	max
A	4.78	5.28	0.1882	0.2079
B	2.29	2.51	0.0902	0.0988
C	1.78	2.29	0.0701	0.0902
D	1.09	1.32	0.0429	0.0520
E	1.73	2.06	0.0681	0.0811
F	2.67	3.18	0.1051	0.1252
G	0.76 max		0.0299 max	
H	20.80	21.16	0.8189	0.8331
K	15.65	16.15	0.6161	0.6358
L	5.21	5.72	0.2051	0.2252
M	19.81	20.68	0.7799	0.8142
N	3.560	4.930	0.1402	0.1941
∅P	3.61		0.1421	
Q	6.12	6.22	0.2409	0.2449

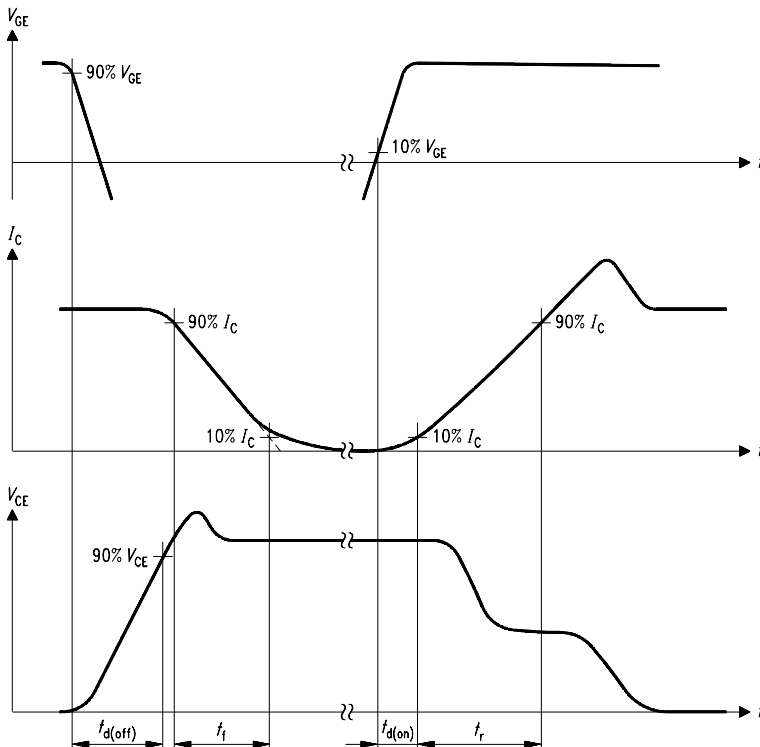


Figure A. Definition of switching times

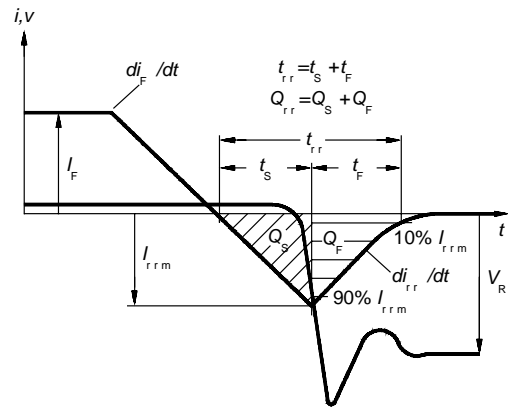


Figure C. Definition of diodes switching characteristics

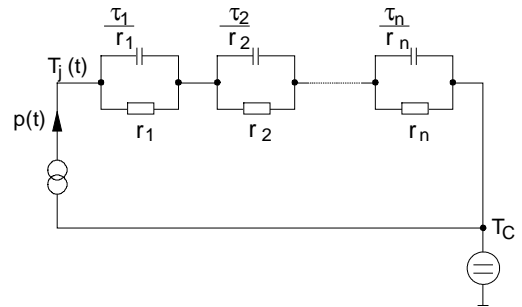


Figure D. Thermal equivalent circuit

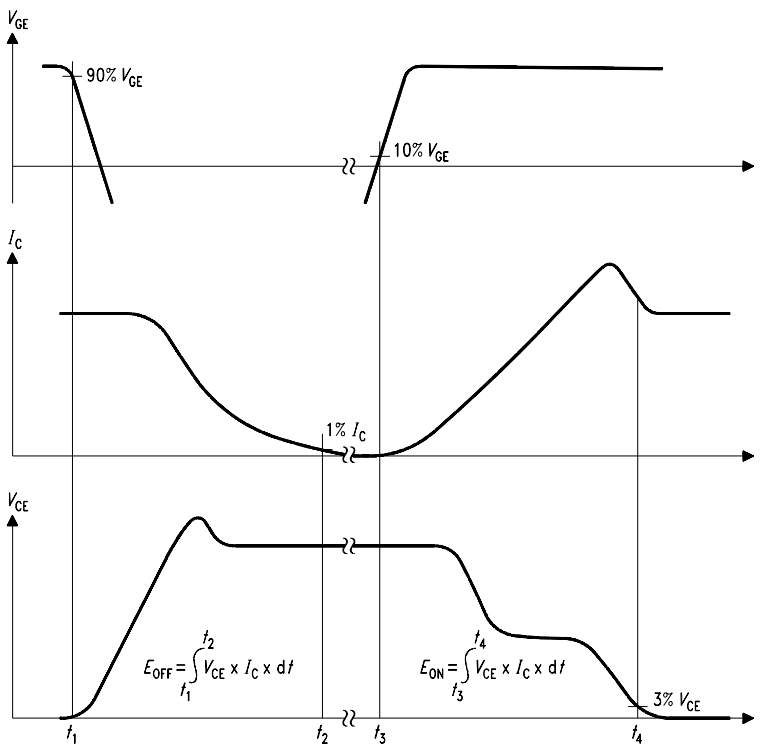


Figure B. Definition of switching losses

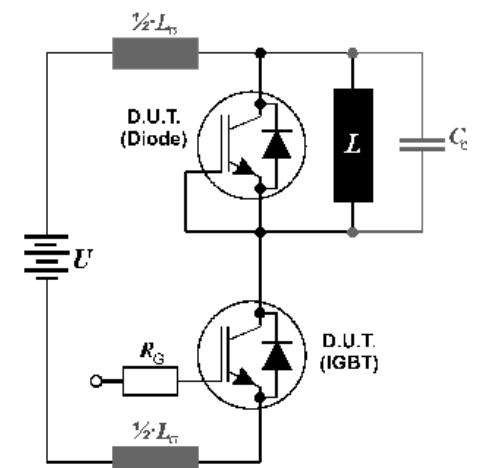


Figure E. Dynamic test circuit  
Leakage inductance  $L_{\sigma} = 180\text{nH}$   
and Stray capacity  $C_{\sigma} = 250\text{pF}$ .

**Bereich Kommunikation**  
**St.-Martin-Strasse 53,**  
**D-81541 München**  
**© Infineon Technologies AG 2000**  
**All Rights Reserved.**

**Attention please!**

The information herein is given to describe certain components and shall not be considered as warranted characteristics.

Terms of delivery and rights to technical change reserved.

We hereby disclaim any and all warranties, including but not limited to warranties of non-infringement, regarding circuits, descriptions and charts stated herein.

Infineon Technologies is an approved CECC manufacturer.

**Information**

For further information on technology, delivery terms and conditions and prices please contact your nearest Infineon Technologies Office in Germany or our Infineon Technologies Representatives worldwide (see address list).

**Warnings**

Due to technical requirements components may contain dangerous substances. For information on the types in question please contact your nearest Infineon Technologies Office.

Infineon Technologies Components may only be used in life-support devices or systems with the express written approval of Infineon Technologies, if a failure of such components can reasonably be expected to cause the failure of that life-support device or system, or to affect the safety or effectiveness of that device or system. Life support devices or systems are intended to be implanted in the human body, or to support and/or maintain and sustain and/or protect human life. If they fail, it is reasonable to assume that the health of the user or other persons may be endangered.