

DATA SHEET

SKY65014-92LF: InGaP Cascadable Amplifier LF-9 GHz

www.dataSheet4U.com

Features

- Broadband: LF-9 GHz
- Small signal gain: 15 dB typ. @ 2 GHz
- High output 3rd order intercept: 36 dBm typ.
- OP_1 dB: 18 dBm typ. @ 2 GHz
- Input and output impedance: 50 Ω nominal
- Single, positive DC supply voltage
- Miniature SC-88 package
- Available lead (Pb)-free and RoHS-compliant MSL-1 @ 260 °C per JEDEC J-STD-020

Applications

- Wireless infrastructure: WLAN, HLAN, DBS, broadband, cellular base stations
- Test instrumentation
- CATV

Description

The SKY65014 is a general-purpose, broadband amplifier fabricated from Skyworks InGaP HBT process and packaged in a miniature SC-88 package. The amplifier's input and output impedances are 50 Ω , which allows these amplifiers to be cascaded without external impedance matching networks. The typical -3 dB bandwidth of the SKY65014 is LF-9 GHz.

This amplifier is also available in the plastic micro-X package (SKY65014-214LF) and the SOT-89 package (SKY65014-70LF).

Functional Block Diagram

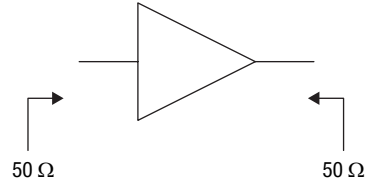

NEW Skyworks offers lead (Pb)-free, RoHS (Restriction of Hazardous Substances)-compliant packaging.



The SKY65014 is lead (Pb)-free and RoHS-compliant.

A populated evaluation board is available upon request.

Full scattering parameters for this part are available for download at www.skyworksinc.com.

Electrical Specifications at 25 °C

T = 25 °C, I_S = 70 mA, P_{IN} = 0 dBm, Z₀ = 50 Ω, measured in evaluation board, unless otherwise noted

Parameter	Symbol	Condition	Frequency	Min.	Typ.	Max.	Unit
Small signal gain	GP		2 GHz	13	15	16	dB
3 dB gain bandwidth	BW _{3 dB}		3 dB		7.5		GHz
Noise figure	NF		2 GHz		5.4		dB
Output power at 1 dB compression	OP _{1 dB}		2 GHz	17	18		dBm
Input and output VSWR	VSWR		0.1–8 GHz		1.9:1	2.0:1	
Output third order intercept point	OIP3	P _{IN} = 0 dBm each tone, Δf = 10 MHz	2 GHz		36		dBm
Operating voltage	V _D	Measured at pin 6		4.2	4.7	5	V
Reverse isolation	S ₁₂		0.1–7.5 GHz		18		dB
Gain flatness			10 MHz–7.5 GHz		±1.5		dB
Thermal resistance	θ _{JC}				225		°C/W

Typical Performance Data

Z₀ = 50 Ω, I_S = 70 mA, measured in evaluation board, unless otherwise noted

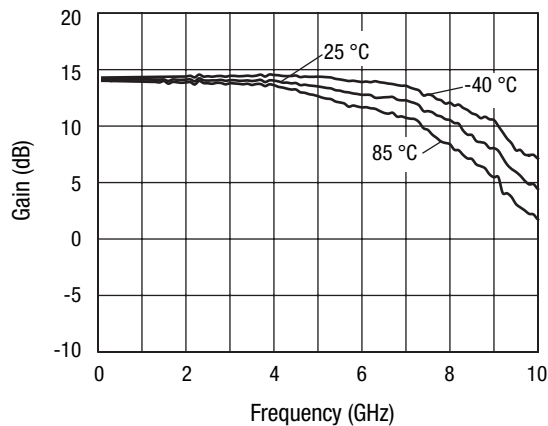

Gain vs. Frequency

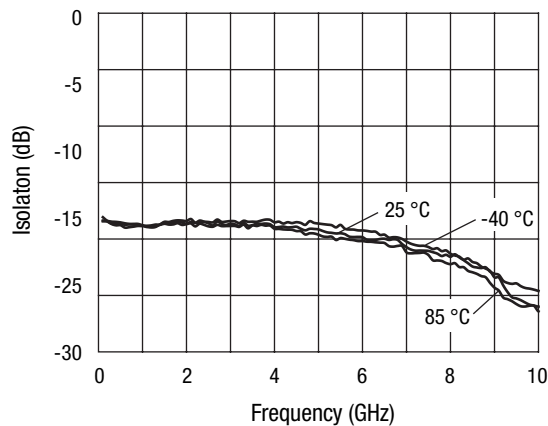

Isolation vs. Frequency

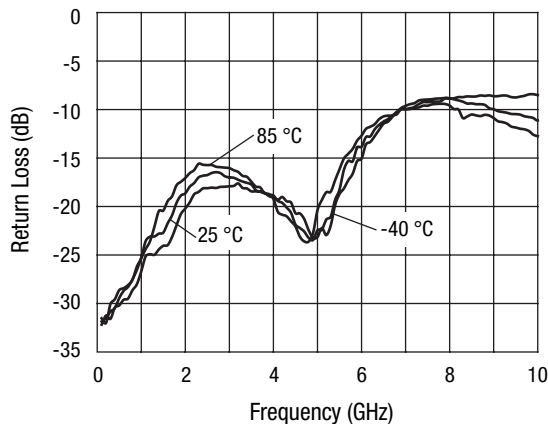

Input Return Loss vs. Frequency

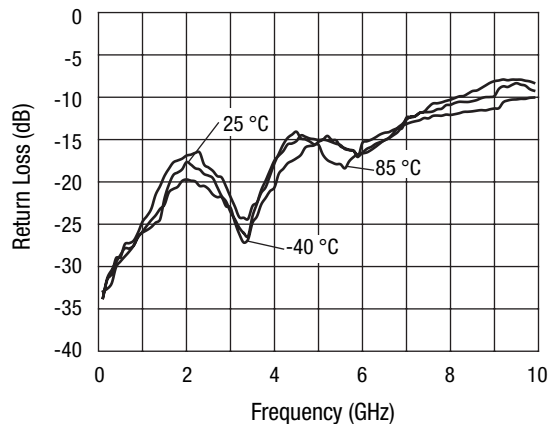

Output Return Loss vs. Frequency

Absolute Maximum Ratings

Characteristic	Value
RF input power	15 dBm
Supply voltage	5 V
Supply current	120 mA
Power dissipation @ T = 25 °C	600 mW
Operating temperature	-40 °C to +85 °C
Storage temperature	-65 °C to +125 °C

Performance is guaranteed only under the conditions listed in the specifications table and is not guaranteed under the full range(s) described by the Absolute Maximum specifications. Exceeding any of the absolute maximum/minimum specifications may result in permanent damage to the device and will void the warranty.

CAUTION: Although this device is designed to be as robust as possible, ESD (Electrostatic Discharge) can damage this device. This device must be protected at all times from ESD. Static charges may easily produce potentials of several kilovolts on the human body or equipment, which can discharge without detection. Industry-standard ESD precautions must be employed at all times.

SC-88 (6-Lead SC-70)

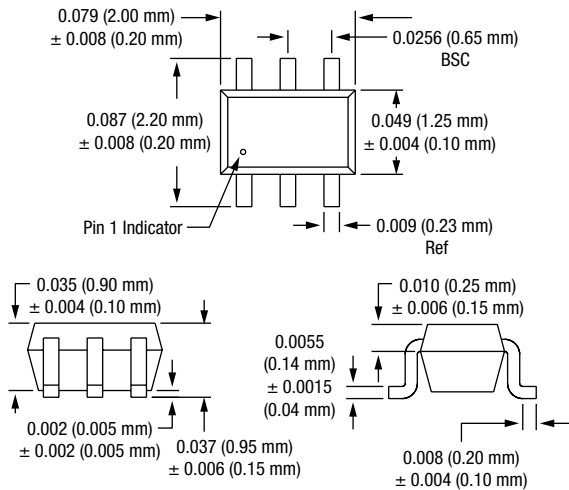

Pin Out (Top View)

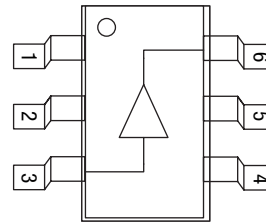

Pin Descriptions

Pin Number	Pin Name	Description
1, 2, 4, 5	GND	Equipotential point – Internal circuit common, which must be connected to the PCB ground or common via the lowest possible impedance.
3	Input	RF input – RF input with 50 Ω nominal input impedance. An internally generated DC voltage is present at this pin, so an external DC block should be used to connect this pin to the external circuit.
6	Output	RF output – DC supply voltage input and RF output with 50 Ω nominal output impedance. The nominal voltage required at this pin is listed in the Electrical Specifications Table. Supply current is determined by an external resistor connected between the DC power supply and this pin.

Recommended Solder Reflow Profiles

Refer to the [“Recommended Solder Reflow Profile”](#) Application Note.

Tape and Reel Information

Refer to the [“Discrete Devices and IC Switch/Attenuators Tape and Reel Package Orientation”](#) Application Note.

Evaluation Board

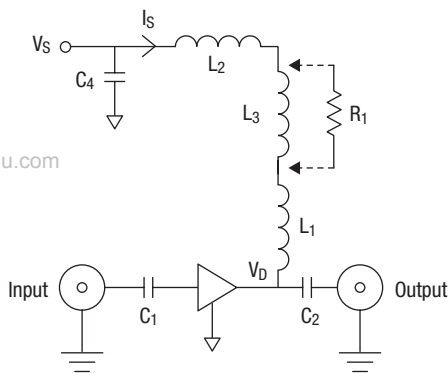

www.datasheet4u.com

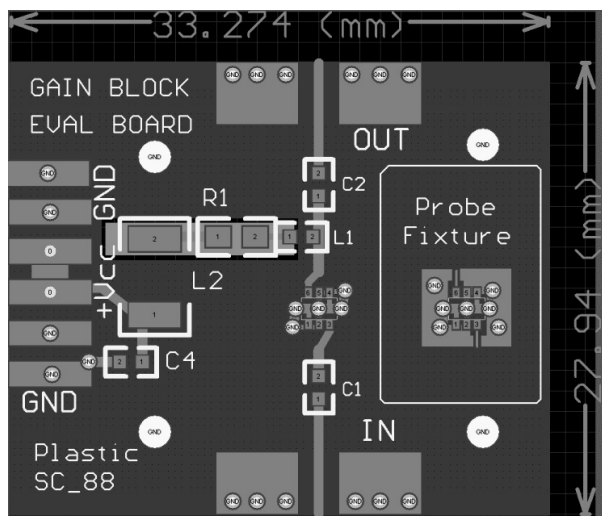

The SKY65014 evaluation board comprises the SKY65014 amplifier, the input and output of which are connected via 50 Ω microstrip transmission lines with DC blocking capacitors, C₁ and C₂, to the input and output SMA connectors, respectively.

The positive supply voltage, V_S, is connected to pin 6, RF Output of the amplifier via the decoupling network, which consists of C₄, L₁, L₂ and R₁. The power supply current, I_S, must be limited, either via the current limit function of an external bench power supply, or by replacing L₃ with resistor R₁, the value of which is given in the Current Limiting Resistor Values table. The evaluation board is shipped with L₃ in place, which shifts an in-band series resonance of the supply decoupling network out of band. For low frequency applications, R₁ may be used to conveniently limit supply current on the evaluation board.

The evaluation board also contains a probe fixture, which facilitates the direct measurement of the s parameters of the SKY65014. The probe fixture comprises a very short coplanar waveguide (CPW) transmission line to pin 3 and an identical line to pin 6. All other pins of the amplifier are grounded. The CPW transmission lines are compatible with ground-signal-ground wafer probe tips, which can be connected to the RF ports of a vector network analyzer (VNA) via coaxial cables. The very small electrical length of these CPW transmission lines obviates the need to de-embed their effects from the s parameters that are measured. The supply constant current must be applied via the bias tee, which is typically integrated into the VNA, which is cascaded with the output pin of the amplifier.

Evaluation Board Parts List

Component	Description	Value	Size	Suggested Part Number	Comments
C ₁ , C ₂ , C ₄	Capacitor	47 nF	0603		
L ₁	Inductor	33 nH	0603		
L ₂	Ferrite bead			FBMH4525HM162N-T	
R ₁	Resistor	See Current Limiting Resistor Values Table	0603		
U ₁	Amplifier			SKY65014	

Current Limiting Resistor Values

V _S , V	R ₁ Resistance, Ω	Minimum Power Dissipation Rating, mW
5	4	125
6	19	125
7	33	250
8	47	500
9	61	500
10	76	500
12	104	1000

www.datasheet4u.com

Copyright © 2002, 2003, 2004, 2005, 2006, Skyworks Solutions, Inc. All Rights Reserved.

Information in this document is provided in connection with Skyworks Solutions, Inc. ("Skyworks") products or services. These materials, including the information contained herein, are provided by Skyworks as a service to its customers and may be used for informational purposes only by the customer. Skyworks assumes no responsibility for errors or omissions in these materials or the information contained herein. Skyworks may change its documentation, products, services, specifications or product descriptions at any time, without notice. Skyworks makes no commitment to update the materials or information and shall have no responsibility whatsoever for conflicts, incompatibilities, or other difficulties arising from any future changes.

No license, whether express, implied, by estoppel or otherwise, is granted to any intellectual property rights by this document. Skyworks assumes no liability for any materials, products or information provided hereunder, including the sale, distribution, reproduction or use of Skyworks products, information or materials, except as may be provided in Skyworks Terms and Conditions of Sale.

THE MATERIALS, PRODUCTS AND INFORMATION ARE PROVIDED "AS IS" WITHOUT WARRANTY OF ANY KIND, WHETHER EXPRESS, IMPLIED, STATUTORY, OR OTHERWISE, INCLUDING FITNESS FOR A PARTICULAR PURPOSE OR USE, MERCHANTABILITY, PERFORMANCE, QUALITY OR NON-INFRINGEMENT OF ANY INTELLECTUAL PROPERTY RIGHT; ALL SUCH WARRANTIES ARE HEREBY EXPRESSLY DISCLAIMED. SKYWORKS DOES NOT WARRANT THE ACCURACY OR COMPLETENESS OF THE INFORMATION, TEXT, GRAPHICS OR OTHER ITEMS CONTAINED WITHIN THESE MATERIALS. SKYWORKS SHALL NOT BE LIABLE FOR ANY DAMAGES, INCLUDING BUT NOT LIMITED TO ANY SPECIAL, INDIRECT, INCIDENTAL, STATUTORY, OR CONSEQUENTIAL DAMAGES, INCLUDING WITHOUT LIMITATION, LOST REVENUES OR LOST PROFITS THAT MAY RESULT FROM THE USE OF THE MATERIALS OR INFORMATION, WHETHER OR NOT THE RECIPIENT OF MATERIALS HAS BEEN ADVISED OF THE POSSIBILITY OF SUCH DAMAGE.

Skyworks products are not intended for use in medical, lifesaving or life-sustaining applications, or other equipment in which the failure of the Skyworks products could lead to personal injury, death, physical or environmental damage. Skyworks customers using or selling Skyworks products for use in such applications do so at their own risk and agree to fully indemnify Skyworks for any damages resulting from such improper use or sale.

Customers are responsible for their products and applications using Skyworks products, which may deviate from published specifications as a result of design defects, errors, or operation of products outside of published parameters or design specifications. Customers should include design and operating safeguards to minimize these and other risks. Skyworks assumes no liability for applications assistance, customer product design, or damage to any equipment resulting from the use of Skyworks products outside of stated published specifications or parameters.

Skyworks, the Skyworks symbol, and "Breakthrough Simplicity" are trademarks or registered trademarks of Skyworks Solutions, Inc., in the United States and other countries. Third-party brands and names are for identification purposes only, and are the property of their respective owners. Additional information, including relevant terms and conditions, posted at www.skyworksinc.com, are incorporated by reference.