

PRELIMINARY DATA SHEET

SKY65113-84LF: Linear Power Amplifier Driver, 1.0 W 400–2300 MHz

Features

- Wideband: 400–2300 MHz
- High linearity: OIP3 > 40 dBm; P_{1 dB} > 30 dBm @ 940 MHz
- High gain > 20 dB @ 940 MHz
- Single-DC supply: 5 V
- Low-cost SMT, lead (Pb)-free package, RoHS-compliant

Applications

- UHF TV broadcast
- TETRA radio
- GSM/CDMA/EDGE 450/750/850/900MHz bands
- DCS, PCS, W-CDMA, UMTS

Description

Skyworks SKY65113 is a high performance power amplifier with superior linearity and output power. The device is fabricated using Skyworks high-reliability Heterojunction Bipolar Transistor (HBT) technology. The device utilizes low-cost, industry-standard, thermally enhanced SOIC-8 lead (Pb)-free, RoHS-compliant packaging.

The SKY65113 incorporates on-chip active bias which achieves excellent gain tracking over temperature and voltage variations.

The SKY65113 is designed for ultrahigh linearity and wideband operation, making it a cost effective building block for many transceiver applications.

The SKY65113 is rated for operation from -40 to +85 °C. It operates from a 5 V power supply voltage.

An evaluation board is available upon request.

Functional Block Diagram

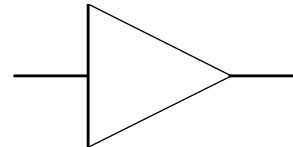

NEW Skyworks offers lead (Pb)-free, RoHS (Restriction of Hazardous Substances)-compliant packaging.



Electrical Specifications

T_A = 25 °C, V_{CC} = 5 V, I_{CCQ} = 450 mA, Z₀ = 50 Ω, as measured in the evaluation board, unless otherwise noted

Parameter	Symbol	Conditions	Min.	Typ.	Max.	Unit
Operational bandwidth			440		460	MHz
Total power-added efficiency	PAE	@ P ₁ dB		36		%
Gain	S ₂₁			23		dB
Output P ₁ dB	OP ₁ dB			29.7		dBm
Output IP3	OIP3	@ 16 dBm P _{OUT} /Tone, 1 MHz Spacing		36.5		dBm
Second harmonic		P _{OUT} @ 450 MHz = 10 dBm		-63		dBc
Third harmonic		P _{OUT} @ 450 MHz = 10 dBm		-88		dBc
Supply current	I _{CCQ}			450		mA
Reference current	I _{REF}			2		mA
Operational bandwidth			920		960	MHz
Total power-added efficiency	PAE	@ P ₁ dB		39		%
Gain	S ₂₁			19.6		dB
Output P ₁ dB	OP ₁ dB			30.6		dBm
Output IP3	OIP3	@ 16 dBm P _{OUT} /Tone, 1 MHz Spacing		40		dBm
Second harmonic		P _{OUT} @ 940 MHz = 10 dBm		-74		dBc
Third harmonic		P _{OUT} @ 940 MHz = 10 dBm		-87		dBc
Supply current	I _{CCQ}			450		mA
Reference current	I _{REF}			2		mA
Operational bandwidth			1930		1990	MHz
Total power-added efficiency	PAE	@ P ₁ dB		28		%
Gain	S ₂₁			12.7		dB
Output P ₁ dB	OP ₁ dB			31.2		dBm
Output IP3	OIP3	@ 16 dBm P _{OUT} /Tone, 1 MHz Spacing		37		dBm
Second harmonic		P _{OUT} @ 1.96 GHz = 10 dBm		-57		dBc
Third harmonic		P _{OUT} @ 1.96 GHz = 10 dBm		-72		dBc
CDMA (IS95) channel power		@ -50 dBc ACPR, 1960 MHz		23		dBm
Supply current	I _{CCQ}			450		mA
Reference current	I _{REF}			2		mA
Operational bandwidth			2110		2170	MHz
Total power-added efficiency	PAE	@ P ₁ dB		28		%
Gain	S ₂₁		12	12.5		dB
Output P ₁ dB	OP ₁ dB			29.2		dBm
Output IP3	OIP3	@ 16 dBm P _{OUT} /Tone, 1 MHz Spacing		36		dBm
Second harmonic		P _{OUT} @ 2.14 GHz = 10 dBm		-61		dBc
Third harmonic		P _{OUT} @ 2.14 GHz = 10 dBm		-73		dBc
W-CDMA channel power		@ -45 dBc ACLR, 2140 MHz		21		dBm
Supply current	I _{CCQ}			450		mA
Reference current	I _{REF}			2		mA

Recommended Operating Conditions

Parameter	Symbol	Min.	Typ.	Max.	Unit
Supply voltage	V_{CC}		5		V
Reference current	I_{REF}		2		mA
Reference voltage	V_{REF}		5		V
Operating frequency		400		2300	MHz
Supply current	I_{CCQ}		450		mA
Junction temperature	T_J			150	°C

Typical Performance Data

$T_A = 25\text{ }^\circ\text{C}$, $V_{CC} = 5\text{ V}$, $I_{CCQ} = 260\text{ mA}$, $Z_0 = 50\text{ }\Omega$, unless otherwise noted

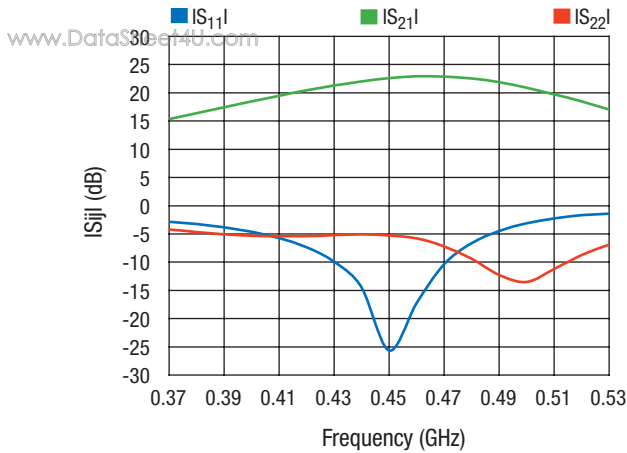

SKY65113 Tuned for 450 MHz

$V_{CC} = 5\text{ V}$, $V_{REF} = 5\text{ V}$, $I_{CCQ} = 450\text{ mA}$

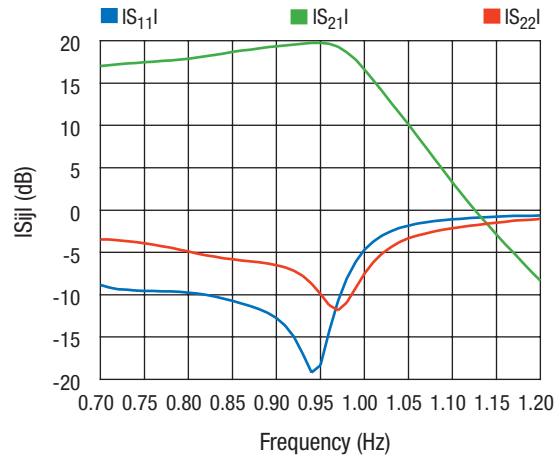

SKY65113 Tuned for 940 MHz

$V_{CC} = 5\text{ V}$, $V_{REF} = 5\text{ V}$, $I_{CCQ} = 450\text{ mA}$

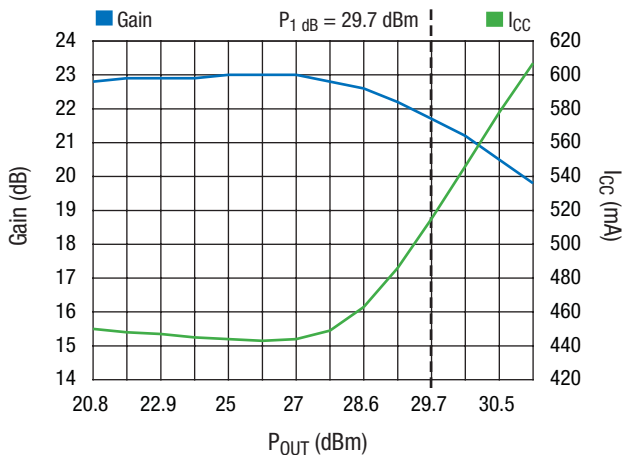

SKY65113 Gain, I_{CC} vs. P_{OUT}

$V_{CC} = 5\text{ V}$, $V_{REF} = 5\text{ V}$, $I_{CCQ} = 450\text{ mA}$, $F = 450\text{ MHz}$

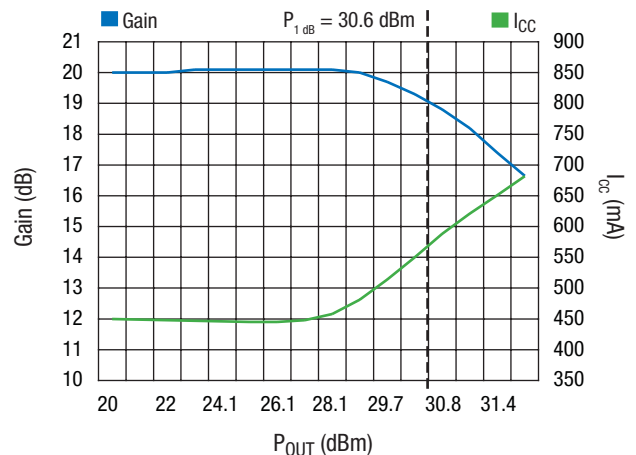

SKY65113 Gain, I_{CC} vs. P_{OUT}

$V_{CC} = 5.3\text{ V}$, $V_{REF} = 5\text{ V}$, $I_{CCQ} = 450\text{ mA}$, $F = 940\text{ MHz}$

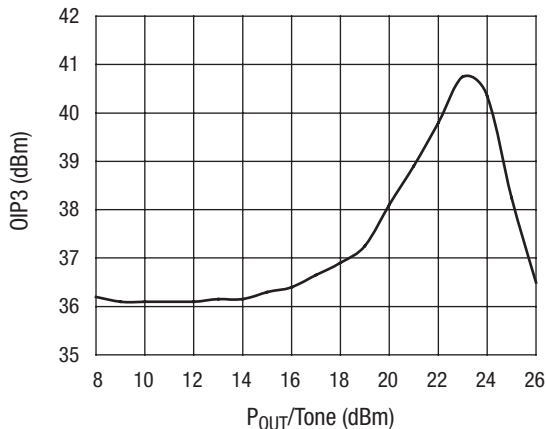

SKY65113 OIP3, $V_{CC} = 5\text{ V}$, $V_{REF} = 5\text{ V}$,
 $I_{CCQ} = 450\text{ mA}$, $F = 450\text{ MHz}$, Tone Spacing = 1 MHz

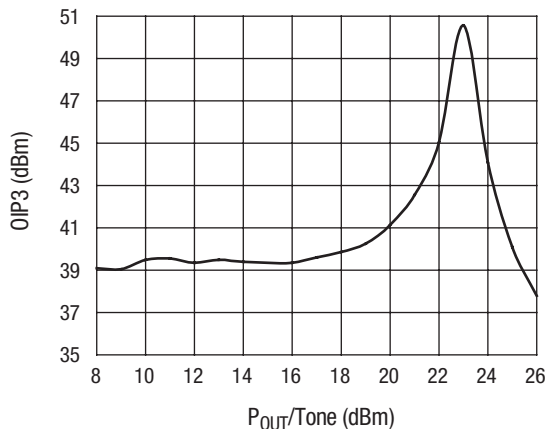

SKY65113 OIP3, $V_{CC} = 5\text{ V}$, $V_{REF} = 5\text{ V}$,
 $I_{CCQ} = 450\text{ mA}$, $F = 940\text{ MHz}$, Tone Spacing = 1 MHz

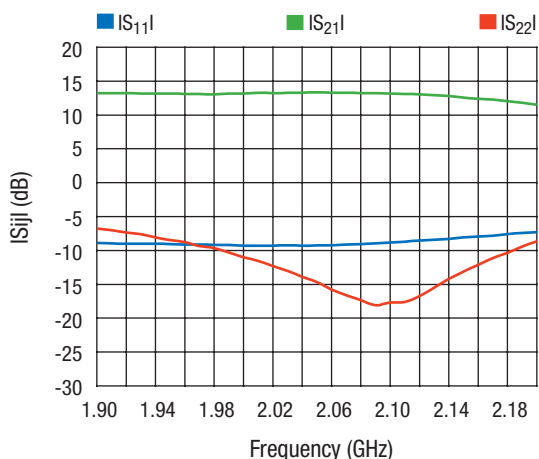

SKY65113 Tuned for 1960–2140 MHz
 $V_{CC} = 5\text{ V}$, $V_{REF} = 5\text{ V}$, $I_{CCQ} = 450\text{ mA}$

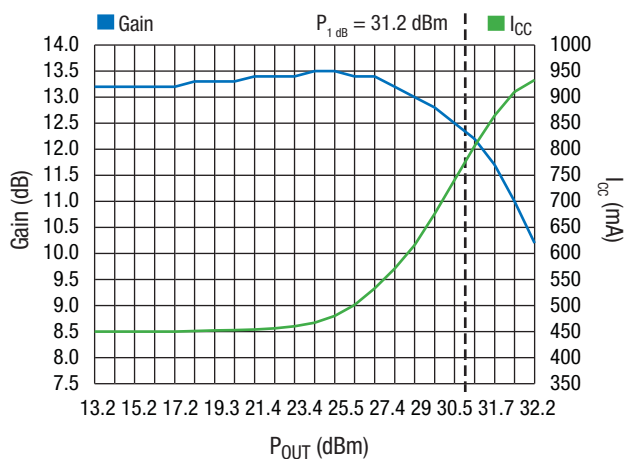

SKY65113 Gain, I_{CC} vs. P_{OUT}
 $V_{CC} = 5\text{ V}$, $V_{REF} = 5\text{ V}$, $I_{CCQ} = 450\text{ mA}$, $F = 1960\text{ MHz}$

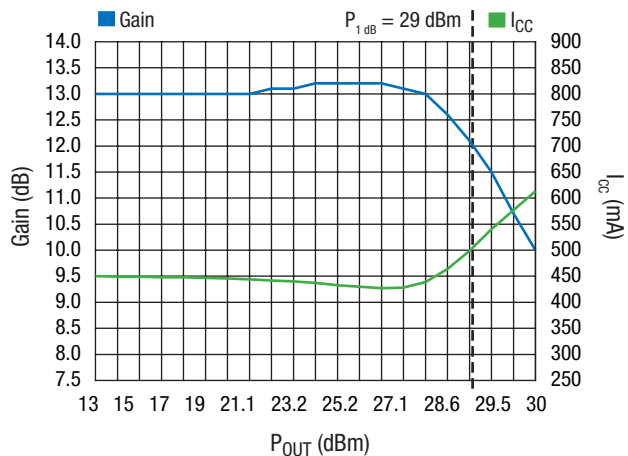

SKY65113 Gain, I_{CC} vs. P_{OUT}
 $V_{CC} = 5\text{ V}$, $V_{REF} = 5\text{ V}$, $I_{CCQ} = 450\text{ mA}$, $F = 2140\text{ MHz}$

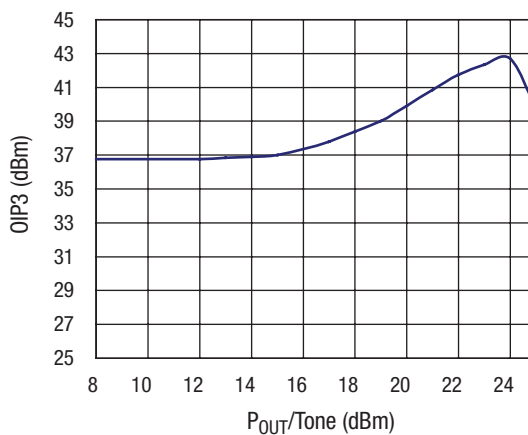

SKY65113 OIP3, $V_{CC} = 5\text{ V}$, $V_{REF} = 5\text{ V}$,
 $I_{CCQ} = 450\text{ mA}$, $F = 1960\text{ MHz}$, Tone Spacing = 1 MHz

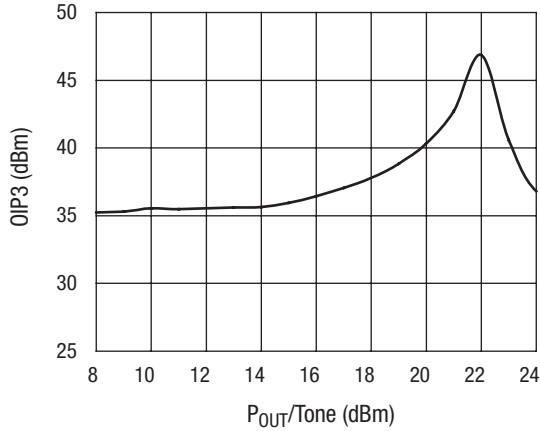

SKY65113 OIP3, $V_{CC} = 5\text{ V}$, $V_{REF} = 5\text{ V}$, $I_{CCQ} = 450\text{ mA}$, $F = 2140\text{ MHz}$, Tone Spacing = 1 MHz

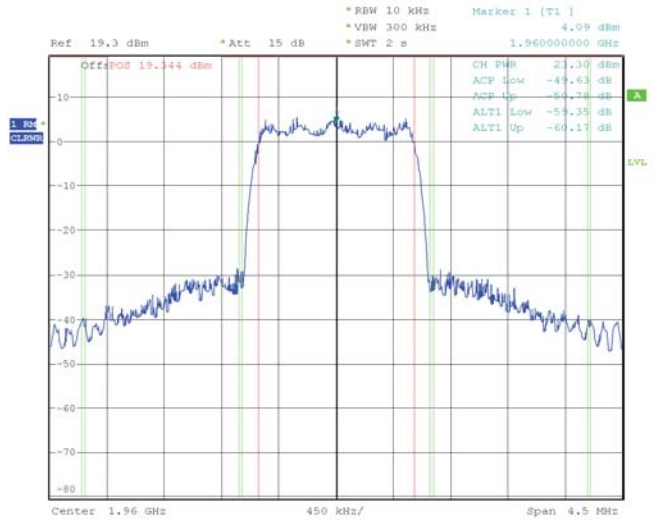

SKY65113 IS-95, $F = 1960\text{ MHz}$, $V_{CC} = 5\text{ V}$, $V_{REF} = 5\text{ V}$, $I_{CCQ} = 450\text{ mA}$, Clock freq 9.8304 MHz

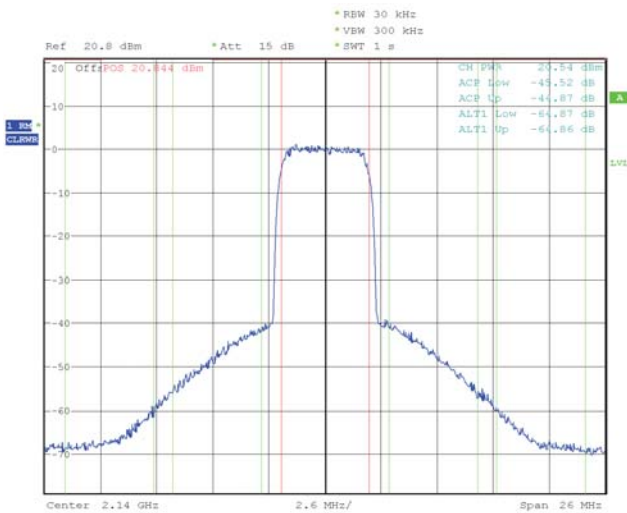

SKY65113 3GPP WCDMA, $F = 2140\text{ MHz}$, QPSK 45° Offset, Filter Root Cosine, Roll-off Factor 0.22, Symbol Rate 3.84 Msym/s, $V_{CC} = 5\text{ V}$, $V_{REF} = 5\text{ V}$, $I_{CCQ} = 450\text{ mA}$

Absolute Maximum Ratings

Characteristic	Value
RF input power (P_{IN})	27 dBm
Supply voltage (V_{CC})	8 V
Reference current (I_{REF})	10 mA
Total supply current ($I_{CC} + I_{REF}$)	750 mA
Power dissipation (P_{DISS})	2 W
Case operating temperature ⁽¹⁾ (T_C)	-40 to +85 °C
Storage temperature (T_{ST})	-50 to +150 °C
Junction temperature (T_J)	-50 to +155 °C
Thermal resistance (θ_{JC})	30°C/W

1. Case temperature is defined as the temperature of the surface of the exposed paddle where it is soldered to the printed circuit board ground. This surface must be connected via the lowest possible thermal impedance to an adequate heatsink.

Performance is guaranteed only under the conditions listed in the specifications table and is not guaranteed under the full range(s) described by the Absolute Maximum specifications. Exceeding any of the absolute maximum/minimum specifications may result in permanent damage to the device and will void the warranty.

CAUTION: Although this device is designed to be as robust as possible, ESD (Electrostatic Discharge) can damage this device. This device must be protected at all times from ESD. Static charges may easily produce potentials of several kilovolts on the human body or equipment, which can discharge without detection. Industry-standard ESD precautions must be employed at all times.

Technical Description

The SKY65113 is a single stage linear amplifier. The device should be externally matched for optimum gain and linearity using external passive components on the input and on the output ports. These external components allow the amplifier to be optimized for the desired operating frequency.

The RF input is internally connected to pins 2, 3 and 4 via different lengths of bond wire. The inductances produced by these bond wires can be utilized in the impedance matching circuit on the amplifier’s input port.

The RF output is internally connected to pins 6 and 7 for current sharing. Both of these pins should be connected externally to the same printed circuit board trace.

The SKY65113 contains a bias circuit for optimum temperature tracking performance. An external resistor is used to set the bias current level. The value of this resistor can be selected to set the amplifier operational mode to Class A, B, or AB, allowing for optimization of linearity and efficiency.

Package and Handling Information

Since the device package is sensitive to moisture absorption, it is baked and vacuum packed before shipping. Instructions on the shipping container label regarding exposure to moisture after the container seal is broken must be followed. Otherwise, problems related to moisture absorption may occur when the part is subjected to high temperature during solder assembly.

Please refer to Skyworks solder reflow application note, available at www.skyworksinc.com, for instructions on mounting the SKY65113 to a printed circuit board.

Production quantities of this product are shipped in a standard tape and reel format. For packaging details, refer to the Skyworks Application Note, “Tape and Reel,” document number 101568.

Pin Out

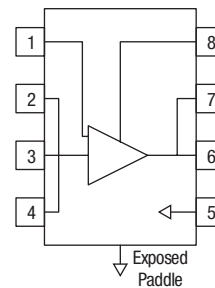

Pin Descriptions

Pin No.	Name	Descriptions
1	V_{REF}	Reference voltage input
2, 3, 4	RF_In	RF input
5	GND	Ground
6, 7	RF_Out	RF output
8	V_{CC}	Supply voltage
Backside	GND	Exposed paddle package ground

Evaluation Board

The SKY65113 Evaluation Board is used to test the performance of the SKY65113 power amplifier driver. Schematic diagrams for evaluation boards circuits, optimized for best output 3rd order intercept point (OIP3), are shown below. Evaluation board schematics and bills of materials are shown for GSM operation at 940 MHz and also for DCS/UMTS/W-CDMA operation near 2 GHz. The mounting footprint for the SKY65113 is shown in the mounting footprint schematic.

The evaluation board also contains a probe fixture section which makes it possible to conveniently measure scattering parameters with ground-signal-ground probes and a vector network analyzer, directly at the input and output pins of the package. Scattering parameters measured in this fixture are available upon request.

www.DataSheet4U.com

Circuit Design Configurations

The following design considerations are general in nature and must be followed regardless of final use or configuration.

1. Paths to ground should be made as short as possible.
2. The exposed paddle ground pad of the SKY65113 power amplifier has special electrical and thermal grounding requirements. This paddle is the main thermal conduit for heat dissipation. Since the circuit board acts as the heat sink, it must shunt as much heat as possible from the amplifier. As such, design the connection to the ground pad to dissipate the maximum power produced to the circuit board. Multiple vias to the grounding layer are required.

NOTE: Junction temperature (T_j) of the device increases with a poor connection to the exposed paddle and ground. This reduces the lifetime of the device.

3. External bypass capacitors are required on the V_{CC} line and on pins 1.
4. Bias resistors R_2 and R_4 and the voltage applied to V_{REF} determine the reference current, I_{REF} , into pin 1. This current controls the supply current through the amplifier stage.

A suggested matching circuit is shown in the evaluation board schematic.

Test Procedure

Use the following procedure to set up the SKY65113 Evaluation Board for testing. Refer to the mounting footprint schematic for guidance:

1. Connect a 5 V supply to V_{CC} . If available, enable the current limiting function of the power supply to 900 mA.
2. Connect a positive supply to V_{REF} .
3. Connect a signal generator to the RF signal input port. Set it to the desired RF frequency at a power level of -15 dBm or less to the evaluation board, but do not enable the RF signal.
4. Connect a spectrum analyzer to the RF signal output port.
5. Enable the power supply.
6. Adjust V_{REF} to set supply current (I_{CCQ}) to 450 mA
7. Enable the RF signal.
8. Take measurements.

CAUTION: If any of the input signals exceed the rated maximum values, the SKY65113 Evaluation Board can be permanently damaged.

Recommended Solder Reflow Profiles

Refer to the "[Recommended Solder Reflow Profile](#)" Application Note.

Tape and Reel Information

Refer to the "[Discrete Devices and IC Switch/Attenuators Tape and Reel Package Orientation](#)" Application Note.

Evaluation Board Schematic

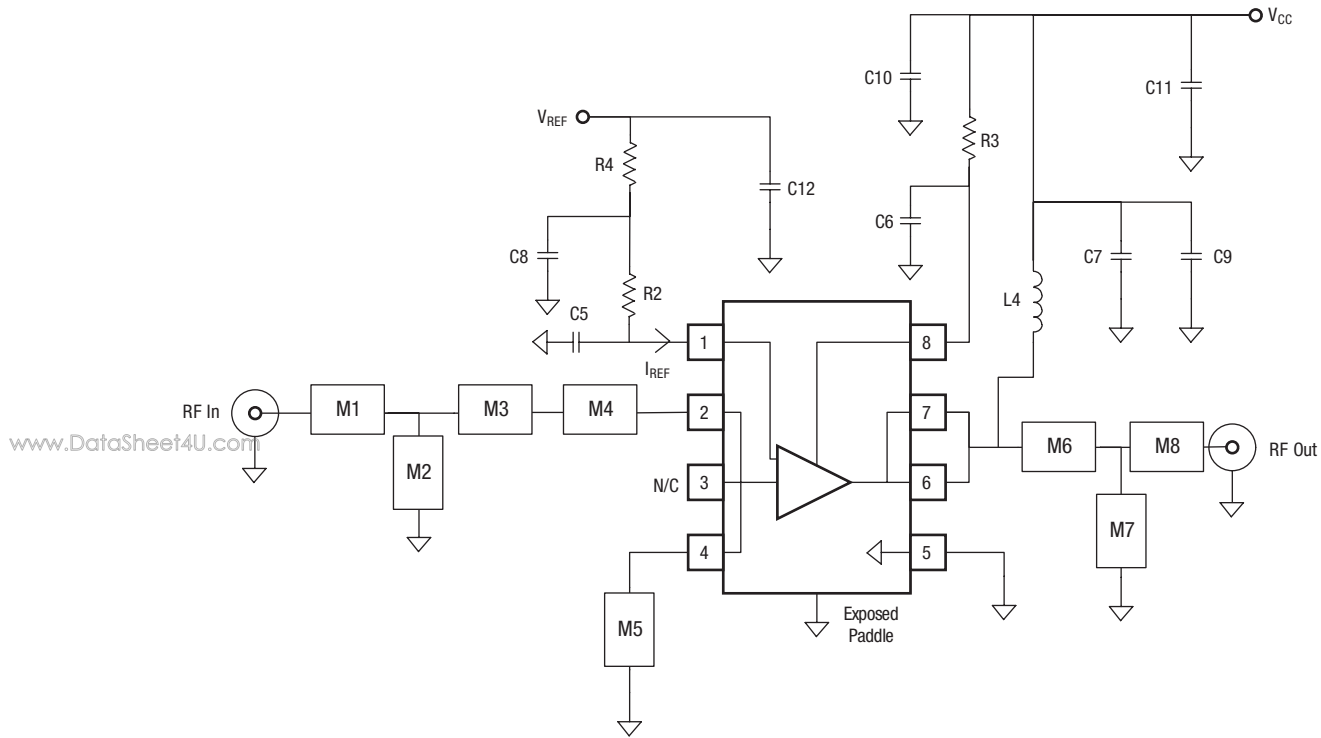

Evaluation Board Component Values vs. Frequency

Component	450 MHz	940 MHz	1960 MHz	2140 MHz
R1	NA	NA	51 Ω	51 Ω
R2	51 Ω	51 Ω	51 Ω	51 Ω
R3	51 Ω	51 Ω	820 Ω	820 Ω
R4	820 Ω	820 Ω	NA	NA
L4	82 nH (0805)	82 nH (0805)	47 nH (0603)	47 nH (0603)
C5	NA	NA	NA	NA
C6	NA	NA	NA	NA
C7	100 pF	22 pF	10 pF	10 pF
C8	2.2 μF	0.1 μF	0.1 μF	0.1 μF
C9	2.2 μF	0.1 μF	0.1 μF	0.1 μF
C10	10 μF	2.2 μF	2.2 μF	2.2 μF
C11	10 μF	4 μF	4 μF	4 μF
C12	10 μF	4 μF	4 μF	4 μF
M1	33 nH	10 nH	100 pF	100 pF
M2	3.9 pF	3.9 pF	2.2 pF	2.2 pF
M3	10 nH	10 nH	NA	NA
M4	10 Ω	0 Ω	NA	NA
M5	5.6 nH	0 Ω	NA	NA
M6	5.6 nH	1.5 nH	NA	NA
M7	18 pF	8.2 pF	3.9 pF	3.9 pF
M8	1000 pF	100 pF	100 pF	100 pF

Test Board Assembly 450, 940 MHz

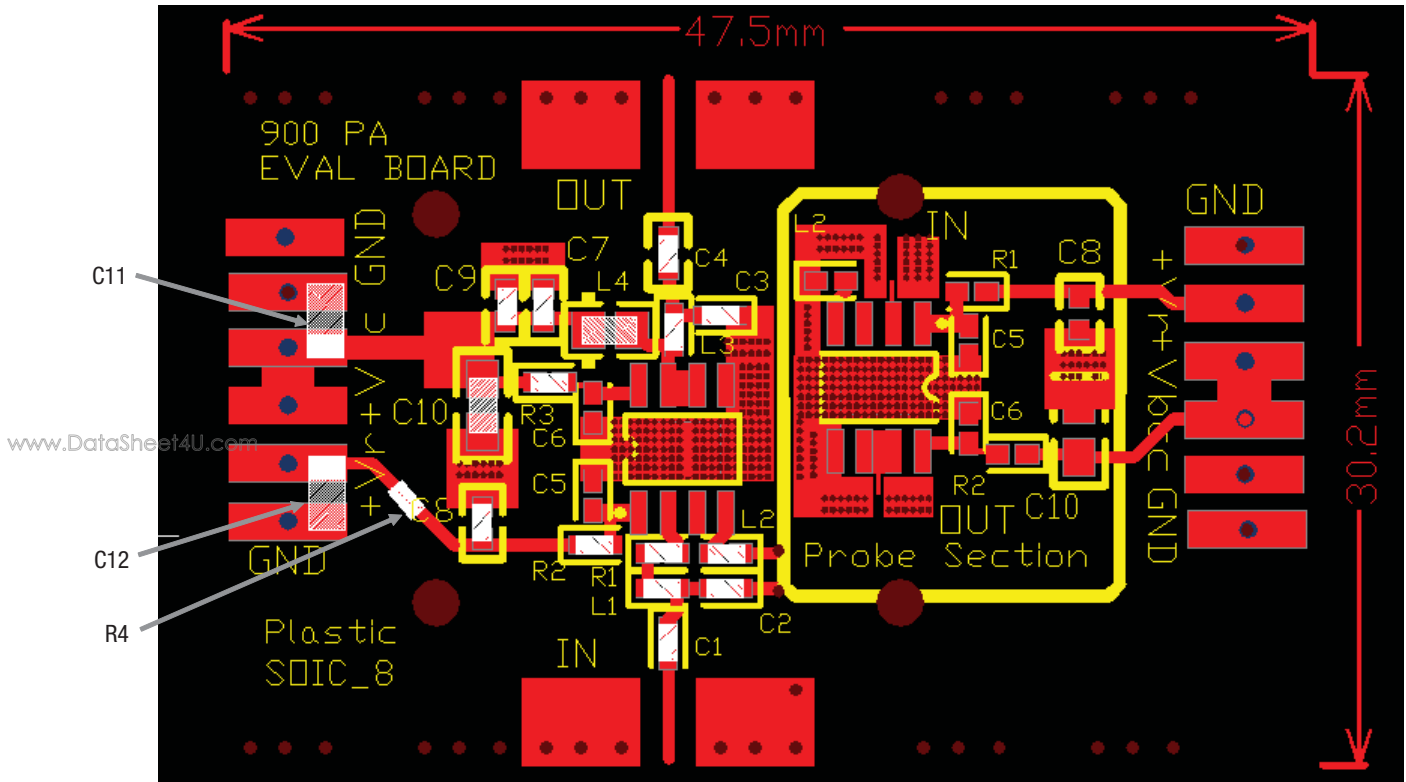

Test Board Assembly 1960, 2140 MHz

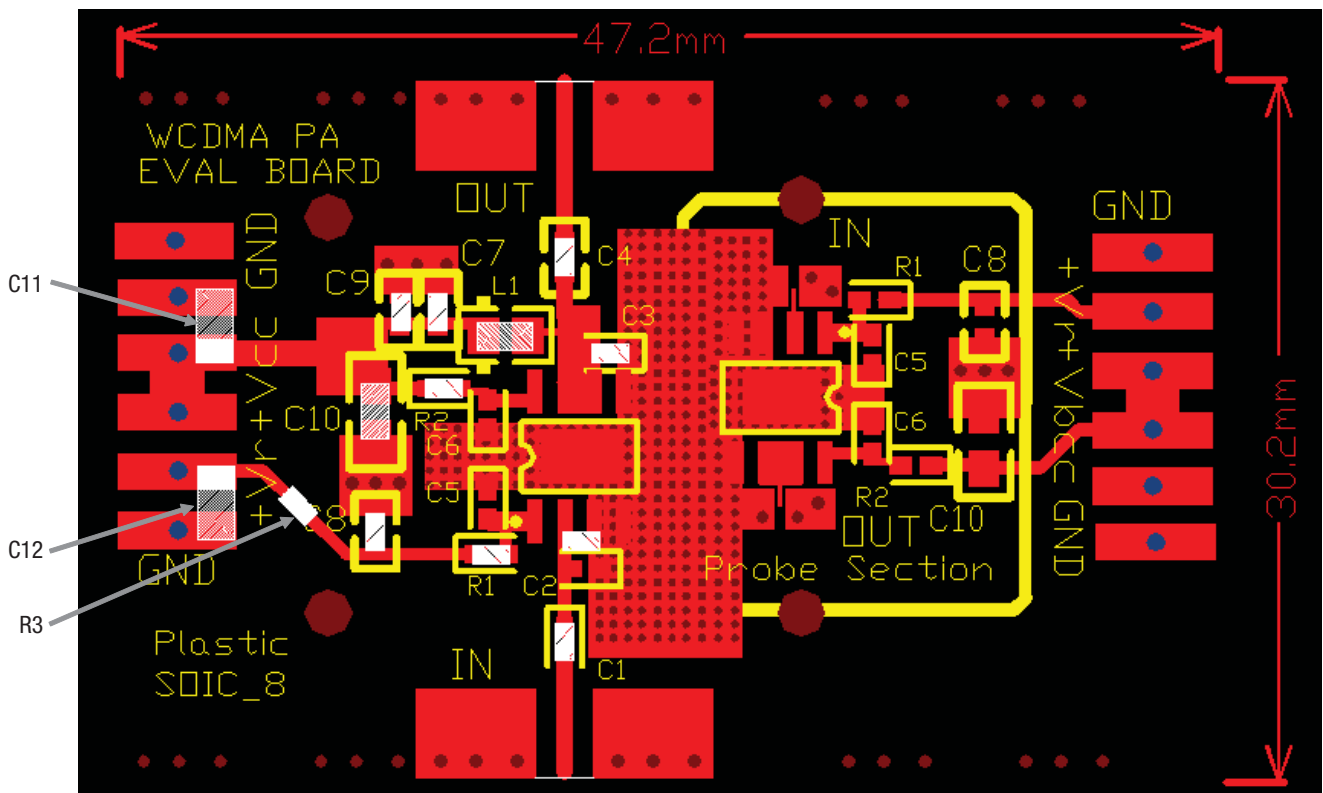

Evaluation Board Test Configuration

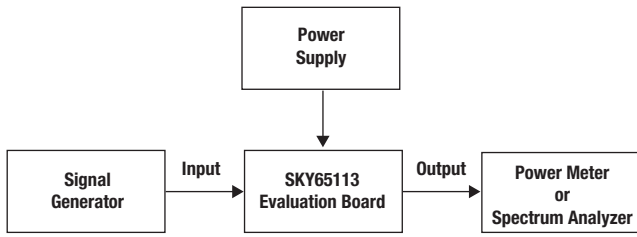

SOIC-8

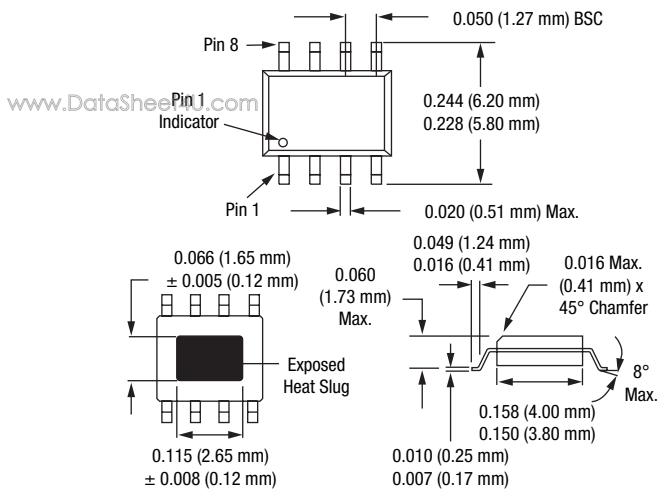

Mounting Footprint

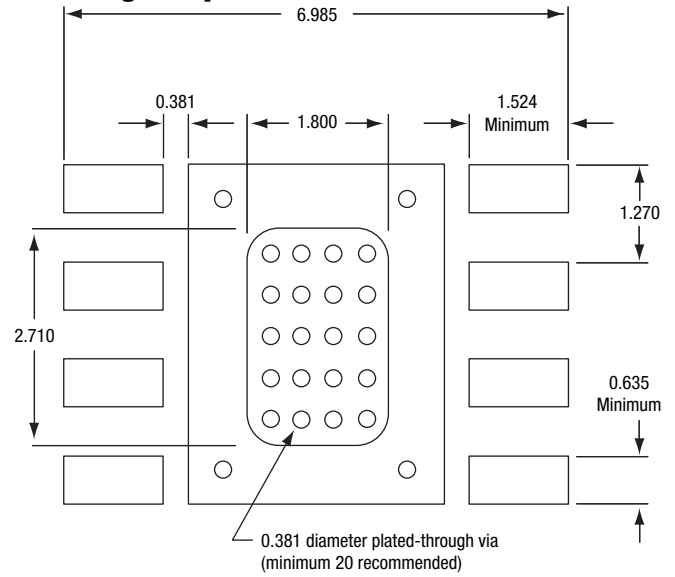

Dimensions in mm.

www.DataSheet4U.com

Copyright © 2002, 2003, 2004, 2005, 2006, Skyworks Solutions, Inc. All Rights Reserved.

Information in this document is provided in connection with Skyworks Solutions, Inc. ("Skyworks") products or services. These materials, including the information contained herein, are provided by Skyworks as a service to its customers and may be used for informational purposes only by the customer. Skyworks assumes no responsibility for errors or omissions in these materials or the information contained herein. Skyworks may change its documentation, products, services, specifications or product descriptions at any time, without notice. Skyworks makes no commitment to update the materials or information and shall have no responsibility whatsoever for conflicts, incompatibilities, or other difficulties arising from any future changes.

No license, whether express, implied, by estoppel or otherwise, is granted to any intellectual property rights by this document. Skyworks assumes no liability for any materials, products or information provided hereunder, including the sale, distribution, reproduction or use of Skyworks products, information or materials, except as may be provided in Skyworks Terms and Conditions of Sale.

THE MATERIALS, PRODUCTS AND INFORMATION ARE PROVIDED "AS IS" WITHOUT WARRANTY OF ANY KIND, WHETHER EXPRESS, IMPLIED, STATUTORY, OR OTHERWISE, INCLUDING FITNESS FOR A PARTICULAR PURPOSE OR USE, MERCHANTABILITY, PERFORMANCE, QUALITY OR NON-INFRINGEMENT OF ANY INTELLECTUAL PROPERTY RIGHT; ALL SUCH WARRANTIES ARE HEREBY EXPRESSLY DISCLAIMED. SKYWORKS DOES NOT WARRANT THE ACCURACY OR COMPLETENESS OF THE INFORMATION, TEXT, GRAPHICS OR OTHER ITEMS CONTAINED WITHIN THESE MATERIALS. SKYWORKS SHALL NOT BE LIABLE FOR ANY DAMAGES, INCLUDING BUT NOT LIMITED TO ANY SPECIAL, INDIRECT, INCIDENTAL, STATUTORY, OR CONSEQUENTIAL DAMAGES, INCLUDING WITHOUT LIMITATION, LOST REVENUES OR LOST PROFITS THAT MAY RESULT FROM THE USE OF THE MATERIALS OR INFORMATION, WHETHER OR NOT THE RECIPIENT OF MATERIALS HAS BEEN ADVISED OF THE POSSIBILITY OF SUCH DAMAGE.

Skyworks products are not intended for use in medical, lifesaving or life-sustaining applications, or other equipment in which the failure of the Skyworks products could lead to personal injury, death, physical or environmental damage. Skyworks customers using or selling Skyworks products for use in such applications do so at their own risk and agree to fully indemnify Skyworks for any damages resulting from such improper use or sale.

Customers are responsible for their products and applications using Skyworks products, which may deviate from published specifications as a result of design defects, errors, or operation of products outside of published parameters or design specifications. Customers should include design and operating safeguards to minimize these and other risks. Skyworks assumes no liability for applications assistance, customer product design, or damage to any equipment resulting from the use of Skyworks products outside of stated published specifications or parameters.

Skyworks, the Skyworks symbol, and "Breakthrough Simplicity" are trademarks or registered trademarks of Skyworks Solutions, Inc., in the United States and other countries. Third-party brands and names are for identification purposes only, and are the property of their respective owners. Additional information, including relevant terms and conditions, posted at www.skyworksinc.com, are incorporated by reference.