

**DATA SHEET**

# SKY65313-21: 900 MHz Transmit/Receive Front-End Module

## Applications

- Automated meter reading
- Advanced metering infrastructure
- ISM systems

## Features

- Transmit output power > +30.5 dBm
- High efficiency PA
- Analog power control
- Receive path NF < 1.9 dB
- LNA bypass mode
- Integrated control logic
- Internal RF match and bias circuits
- All RF ports internally DC blocked
- Shutdown mode
- Small footprint, MCM (28-pin, 6 x 6 mm) package (MSL3, 260 °C per JEDEC J-STD-020)



Skyworks Green™ products are compliant with all applicable legislation and are halogen-free. For additional information, refer to *Skyworks Definition of Green™*, document number SQ04-0074.

## Description

Skyworks SKY65313-21 is a high performance, transmit/receive (T/R) Front-End Module (FEM). The device provides a complete T/R chain with T/R switches.

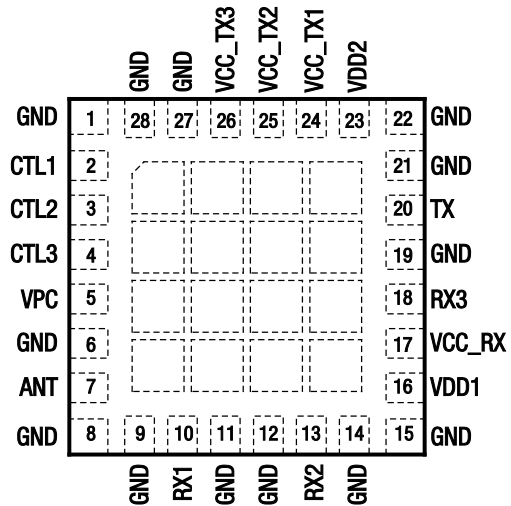
The device transmit chain features +30.5 dBm output power and a 40 percent Power Added Efficiency (PAE).

The device receive chain features a Low Noise Amplifier (LNA) with a 1.4 dB Noise Figure (NF) and 16.6 dB gain. The cascaded NF and gain, taking into account the 0.5 dB insertion loss transmit/receive antenna switch, are 1.9 dB and 16.1 dB, respectively, which makes the SKY65313-21 ideal for medium power microwave links such as 900 MHz Industrial, Scientific and Medical (ISM) band applications.

The module also has a shut-down mode and LNA bypass mode to minimize power consumption.

The device is mounted in a 28-pin, 6 x 6 mm Multi-Chip Module (MCM) Surface-Mounted Technology (SMT) package, which allows for a highly manufacturable low-cost solution.

The device package and pinout for the 28-pin MCM are shown in Figure 1. A block diagram of the SKY65313-21 is shown in Figure 2. Signal pin assignments and functional pin descriptions are provided in Table 1.



S2126

**Figure 1. SKY65313-21 Pinout – 28-Pin MCM (Top View)**

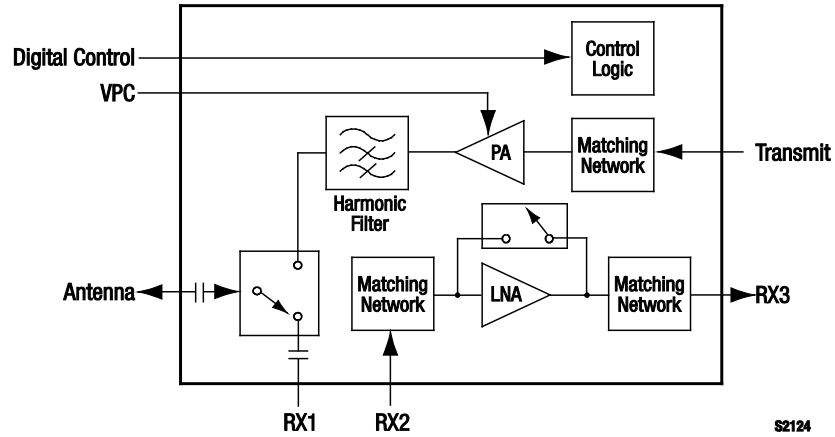


Figure 2. SKY65313-21 Block Diagram

Table 1. SKY65313-21 Signal Descriptions

Pin #	Name	Description	Pin #	Name	Description
1	GND	Ground	15	GND	Ground
2	CTL1	Transmit/receive mode digital control input	16	VDD1	3.3 V power supply
3	CTL2	Shutdown mode digital control input	17	VCC_RX	3.3 V power supply
4	CTL3	Receive bypass mode digital control input	18	RX3	LNA and bypass switch output port. Internally matched to 50 Ω.
5	VPC	Transmit output power analog control voltage input	19	GND	Ground
6	GND	Ground	20	TX	PA input port. Internally matched to 50 Ω.
7	ANT	Antenna switch common port. Internally matched to 50 Ω.	21	GND	Ground
8	GND	Ground	22	GND	Ground
9	GND	Ground	23	VDD2	4.0 V power supply
10	RX1	Receive arm of antenna switch. Internally matched to 50 Ω.	24	VCC_TX1	4.0 V power supply
11	GND	Ground	25	VCC_TX2	4.0 V power supply
12	GND	Ground	26	VCC_TX3	4.0 V power supply
13	RX2	LNA and bypass switch input port	27	GND	Ground
14	GND	Ground	28	GND	Ground

### Technical Description

The SKY65313-21 consists of a complete T/R chain with T/R switches contained in the module. A Single-Pole Double-Throw (SPDT) switch selects between the receive and transmit paths. The module has a shut-down mode to minimize power consumption.

Three digital input pins (CTL1, CTL2, and CTL3) are used to select between transmit, receive, receive bypass, or shutdown mode.

### Transmit Path

The transmit path contains a Power Amplifier (PA) optimized for saturated performance. The PA output is internally matched for optimum output power and efficiency into a 50 Ω load impedance. The PA output is passed through an harmonic filter before being fed through the SPDT switch. The PA input provides a good return loss into a 50 Ω source impedance.

Transmit output power is controlled by the VPC pin, which is normally set to 2.25 V DC voltage. The nominal DC input impedance into the VPC pin is 50 kΩ.

### Receive Path

The receive path contains an LNA with bypass switch. The LNA impedance matching networks are internal to the module and have been optimized for a low NF while maintaining good return losses into a 50 Ω source and load impedance. The receive arm of the SPDT switch and the LNA input are connected to module pins to allow an external filter to be inserted into the receive path.

### Operation Mode Control

The four SKY65313-21 operating modes are controlled by the three digital pins CTL1, CTL2, and CTL3 (pins 2, 3, and 4, respectively). The control logic truth Table is provided in Table 2.

### Electrical and Mechanical Specifications

The absolute maximum ratings of the SKY65313-21 are provided in Table 3. Recommended operating conditions are specified in Table 4. Electrical specifications are provided in Tables 5, 6, and 7.

Typical performance characteristics of the SKY65313-21 are illustrated in Figures 3 through 22.

**Table 2. SKY65313-21 Operating Modes Truth Table (Note 1)**

Operating Mode	Control Voltage			Internal States			
	CTL1 (Pin 2)	CTL2 (Pin 3)	CTL3 (Pin 4)	PA	LNA	LNA Bypass Switch	T/R Switch
Transmit	1	1	X	On	Off	Open	Transmit
Receive	0	1	0	Off	On	Open	RX1
Receive Bypass	0	1	1	Off	Off	Through	RX1
Shutdown (Note 2)	X	0	X	Off	Off	Open	RX1

**Note 1:** See Recommended Operating Conditions Table for logic 0 and 1 characteristics. "X" = don't care state, defined as a valid state of logic 1 or 0.

**Note 2:** In the high state, CTL1, CTL2, and CTL3 have an input current of 33 μA due to an internal 100 kΩ pull-down. In the shutdown mode, for the lowest leakage current, the high state is not recommended for CTL1 and CTL3.

**Table 3. SKY65313-21 Absolute Maximum Ratings (Note 1)**

Parameter	Symbol	Minimum	Maximum	Units
LNA supply voltage	VCC_RX	-0.3	+5.0	V
LNA supply current	I <sub>cc1</sub>		20	mA
PA supply voltage	VCC_TX1/2/3	-0.3	+5.0	V
PA supply current	I <sub>cc2</sub>		1.6	A
Digital supply voltage	V <sub>DD1</sub>	-0.5	+5.5	V
Digital supply voltage	V <sub>DD2</sub>	-0.5	+5.5	V
Digital control voltage (CTL1, CTL2, CTL3)	V <sub>CTL</sub>	-0.5	V <sub>DD1</sub> + 0.3	V
Transmit output power control voltage (VPC)	V <sub>PC</sub>	-0.3	+5.0	V
Receive RF input power (RX2)	P <sub>IN_RX2</sub>		+5	dBm
Receive RF input power (ANT)	P <sub>IN_ANT</sub>		+33	dBm
Transmit RF input power	P <sub>IN_TX</sub>		+15	dBm
Operating case temperature	T <sub>C</sub>	-40	+85	°C
Storage temperature	T <sub>STG</sub>	-55	+150	°C
Junction temperature	T <sub>J</sub>		+150	°C
T/R port load VSWR in transmit mode	VSWR		10:1	—

**Note 1:** Exposure to maximum rating conditions for extended periods may reduce device reliability. There is no damage to device with only one parameter set at the limit and all other parameters set at or below their nominal value.

Nominal thermal resistance, junction to case, is 18 °C/W.

**CAUTION:** Although this device is designed to be as robust as possible, Electrostatic Discharge (ESD) can damage this device. This device must be protected at all times from ESD. Static charges may easily produce potentials of several kilovolts on the human body or equipment, which can discharge without detection. Industry-standard ESD precautions should be used at all times.

**Table 4. SKY65313-21 Recommended Operating Conditions**

Parameter	Symbol	Minimum	Typical	Maximum	Units
Frequency range	f	860		960	MHz
LNA supply voltage	VCC_RX	3.0	3.3	3.6	V
Digital supply voltage (Note 1)	V <sub>DD1</sub>		VCC_RX		V
PA supply voltage	VCC_TX1/2/3	3.0	4.0	4.4	V
Digital supply voltage (Note 1)	V <sub>DD2</sub>		VCC_TX1/2/3		V
Digital input voltage, logic 0 (CTL1, CTL2, CTL3)	V <sub>CTL</sub>	0		0.7	V
Digital input voltage, logic 1 (CTL1, CTL2, CTL3)	V <sub>CTL</sub>	1.6		V <sub>DD1</sub>	V
Transmit output power control voltage (VPC)	V <sub>PC</sub>	0	2.25	2.50	V
Receive RF input power (RX2)	P <sub>IN_RX2</sub>			-15	dBm
Transmit RF input power (TX)	P <sub>IN_TXIN</sub>		+10	+13	dBm
Transmit duty cycle				50	%

**Note 1:** V<sub>DD1</sub> and V<sub>DD2</sub> are diode-coupled together with a typical turn-on voltage of 3.2 V.

**Table 5. SKY65313-21 DC Electrical Specifications (Note 1)**

(VCC\_RX = VDD1 = 3.0 V to 3.6 V, VCC\_TX1/2/3 = VDD2 = 3.6 V to 4.4 V, Tc = -40 °C to +85 °C, No RF Input Power, Unless Otherwise Noted)

Parameter	Symbol	Test Condition	Min	Typical	Max	Units
Quiescent current, receive mode (Note 2)	I <sub>Q_RX</sub>		7.5	12.6	20.0	mA
Quiescent current, receive bypass mode (Note 2)	I <sub>Q_BYP</sub>			46	90	μA
VDD1 quiescent current, transmit mode	I <sub>Q_VDD1</sub>			25	30	mA
VCC_TX1/2/3/quiescent current, transmit mode	I <sub>Q_TXIN</sub>	T <sub>c</sub> = 25 °C, VCC_TX1/2/3 = 4 V, V <sub>PC</sub> = 2.25 V		55	88	mA
VCC_TX1/2/3/ operating current, transmit mode	I <sub>OP_TXIN</sub>	P <sub>IN</sub> = +10 dBm, @ 902 to 928 MHz, V <sub>PC</sub> = 2.25 V		655	826	mA
VCC_RX quiescent current, shutdown mode (Note 2) (Note 3)	I <sub>Q_SDVCC_RX</sub>			0.01		μA
VCC_TX1/2/3 quiescent current, shutdown mode (Note 2) (Note 3)	I <sub>Q_SDVCC_TX1</sub> , I <sub>Q_SDVCC_TX2</sub> , I <sub>Q_SDVCC_TX3</sub>			0.03		μA
Digital input current, logic 1 (Note 3)	I <sub>H</sub>			33		μA
Digital input current, logic 0 (Note 3)	I <sub>L</sub>			0		μA

**Note 1:** Performance is guaranteed only under the conditions listed in this Table.

**Note 2:** Total module power supply current.

**Note 3:** Not production tested.

**Table 6. SKY65313-21 Electrical Specifications: Receive and Receive Bypass Mode (1 of 2) (Note 1)**

(VCC\_RX = VDD1 = 3.0 V to 3.6 V, VCC\_TX1/2/3 = VDD2 = 3.6 V to 4.4 V, Tc = -40 °C to +85 °C, f = 902 to 928 MHz, 50 Ω Source and Load Impedance, CW Input, Unless Otherwise Noted)

Parameter	Symbol	Test Condition	Min	Typical	Max	Units
<b>Receive Mode: RX2 to Receive Output Path</b>						
Small signal gain	G <sub>LNA</sub>		15.6	16.6	18.3	dB
Noise Figure	N <sub>F<sub>LNA</sub></sub>	T <sub>c</sub> = 25 °C, V <sub>CC_RX</sub> = 3.3 V		1.4	1.8	dB
Noise Figure variation over temperature	N <sub>FTEMP</sub>			±0.25		dB
1 dB Input Compression Point	I <sub>P1dB<sub>LNA</sub></sub>	1 dB gain compression	-13	-11		dBm
3 <sup>rd</sup> Order Input Intercept Point	I <sub>P3<sub>LNA</sub></sub>	P <sub>IN</sub> = -30 dBm/tone, 200 kHz spacing	-3.5	0		dBm
Input return loss	IS <sub>11<sub>LNA</sub></sub>		8.0	10.7		dB
Output return loss	IS <sub>22<sub>LNA</sub></sub>		10.0	13.6		dB
Reverse isolation	IS <sub>12<sub>LNA</sub></sub>		20	22		dB
Non-harmonic spurious (Note 2) (Note 3)	P <sub>SPUR<sub>LNA</sub></sub>	VSWR 10:1, all phases			-50	dBm
Transition time (Note 2)	T <sub>LNA</sub>			0.5		μs
<b>Receive Bypass Mode: RX2 to Receive Output Path</b>						
Insertion loss	L <sub>BYP</sub>			3	4	dB
1 dB Input Compression Point	I <sub>P1dB<sub>BYP</sub></sub>	1 dB gain compression	+15	+16		dBm
3 <sup>rd</sup> Order Input Intercept Point	I <sub>P3<sub>BYP</sub></sub>	P <sub>IN</sub> = -30 dBm/tone, 200 kHz spacing	+27	+30		dBm
Input return loss	IS <sub>11<sub>BYP</sub></sub>		12	15		dB

**Table 6. SKY65313-21 Electrical Specifications: Receive and Receive Bypass Mode (2 of 2) (Note 1)**  
**(VCC\_RX = VDD1 = 3.0 V to 3.6 V, VCC\_TX1/2/3 = VDD2 = 3.6 V to 4.4 V, Tc = -40 °C to +85 °C, f = 902 to 928 MHz, 50 Ω Source and Load Impedance, CW Input, Unless Otherwise Noted)**

Parameter	Symbol	Test Condition	Min	Typical	Max	Units
<b>Receive Bypass Mode: RX2 to Receive Output Path (continued)</b>						
Output return loss	IS22 BYP		12	22		dB
Transition time (Note 2)	T <sub>BYP</sub>			0.5		μs
<b>Receive and Receive Bypass Mode: ANT to RX1 Path</b>						
Insertion loss	L <sub>ANT</sub>			0.5	0.9	dB
1 dB Input Compression Point (Note 2)	IP1dB <sub>ANT</sub>	1 dB gain compression		+35		dBm
3 <sup>rd</sup> Order Input Intercept Point (Note 2)	IIP3 <sub>ANT</sub>	P <sub>IN</sub> = -30 dBm/tone, 200 kHz spacing		+50		dBm
Input return loss	IS11 ANT		12	15		dB
Output return loss	IS22 ANT		12	15		dB
Transition time (Note 2)	T <sub>ANT</sub>			0.5		μs

**Note 1:** Performance is guaranteed only under the conditions listed in this Table.

**Note 2:** Not production tested.

**Note 3:** Measurement performed with spectrum analyzer RBW = 100 kHz for frequencies < 1 GHz and RBW = 1 MHz for frequencies between 1 GHz and 10 GHz.

**Table 7. SKY65313-21 Electrical Specifications: Transmit Mode (1 of 2) (Note 1)**  
**(VCC\_RX = VDD1 = 3.0 V to 3.6 V, VCC\_TX2 = VDD2 = 3.6 V to 4.4 V, Tc = -40 °C to +85 °C, f = 902 to 928 MHz, 50 Ω Source and Load Impedance, CW Input, Unless Otherwise Noted)**

Parameter	Symbol	Test Condition	Min	Typical	Max	Units
<b>TXIN to ANT Path</b>						
Saturated output power	P <sub>OUT</sub>	P <sub>IN</sub> = +10 dBm, T <sub>c</sub> = 25 °C, VCC_TX1/2/3 = 4.0 V, V <sub>PC</sub> = 2.25 V	+30.0	+30.5		dBm
Output power variation over supply voltage		P <sub>IN</sub> = +10 dBm, V <sub>PC</sub> = 2.25 V		±0.8		dB
Output power variation over temperature		P <sub>IN</sub> = +10 dBm, V <sub>PC</sub> = 2.25 V		±0.15		dB
Output power control	P <sub>CTL</sub>	P <sub>IN</sub> = +10 dBm, V <sub>PC</sub> = 0 V to 2.7 V (Note 2)	40	50		dB
Power-Added Efficiency	PAE	P <sub>IN</sub> = +10 dBm		41		%
2 <sup>nd</sup> harmonic	2fo	P <sub>IN</sub> = +10 dBm		-36	-20	dBc
3 <sup>rd</sup> harmonic	3fo	P <sub>IN</sub> = +10 dBm		-62	-58	dBc
4 <sup>th</sup> harmonic	4fo	P <sub>IN</sub> = +10 dBm		-76	-66	dBc
5 <sup>th</sup> harmonic	5fo	P <sub>IN</sub> = +10 dBm		-78	-70	dBc
6 <sup>th</sup> – 10 <sup>th</sup> harmonics (Note 3)	6fo – 10fo	P <sub>IN</sub> = +10 dBm			-70	dBc
Input return loss	IS11 TX	P <sub>IN</sub> = +10 dBm, T <sub>c</sub> = 25 °C, VCC_TX1/2/3 = 4.0 V, V <sub>PC</sub> = 2.25 V	10	16		dB
Output impedance (Note 4)	Z <sub>OUT_TX</sub>	P <sub>IN</sub> = +10 dBm		39-j46		Ω
Non-harmonic spurious (Note 4) (Note 5)	P <sub>SPUR_TX</sub>	VSWR 10:1, all phases			-50	dBm
Transition time (Note 4)	T <sub>TX</sub>			0.5		μs

**Table 7. SKY65313-21 Electrical Specifications: Transmit Mode (2 of 2) (Note 1)**  
 (VCC\_RX = VDD1 = 3.0 V to 3.6 V, VCC\_TX2 = VDD2 = 3.6 V to 4.4 V, Tc = -40 °C to +85 °C, f = 902 to 928 MHz, 50 Ω Source and Load Impedance, CW Input, Unless Otherwise Noted)

Parameter	Symbol	Test Condition	Min	Typical	Max	Units
<b>ANT to RX1 Path</b>						
Isolation	S21  <sub>ANT</sub>		18	23		dB

**Note 1:** Performance is guaranteed only under the conditions listed in this Table.

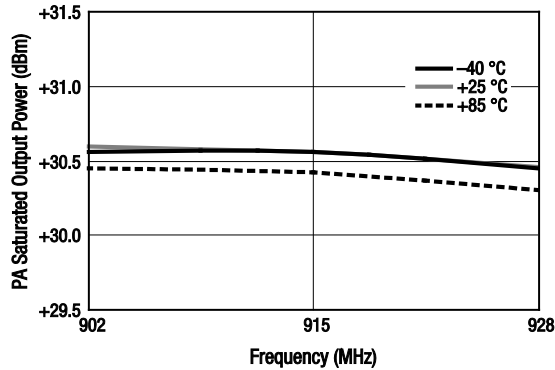
**Note 2:** Output power control is the difference between the output power at VPC = 2.25 V and VPC = 0 V.

**Note 3:** Only the 2<sup>nd</sup> to 5<sup>th</sup> harmonics have been production tested. The 6<sup>th</sup> to 10<sup>th</sup> harmonics are characterized only.

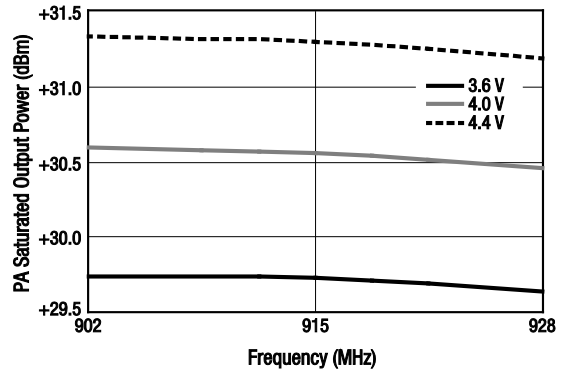
**Note 4:** Not production tested.

**Note 5:** Measurement performed with spectrum analyzer RBW = 100 kHz for frequencies < 1 GHz and RBW = 1 MHz for frequencies between 1 GHz and 10 GHz.

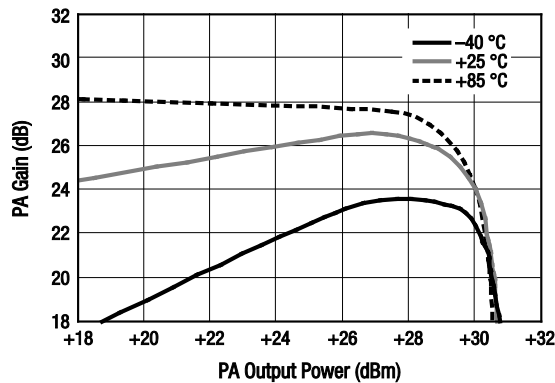
### Typical Performance Characteristics



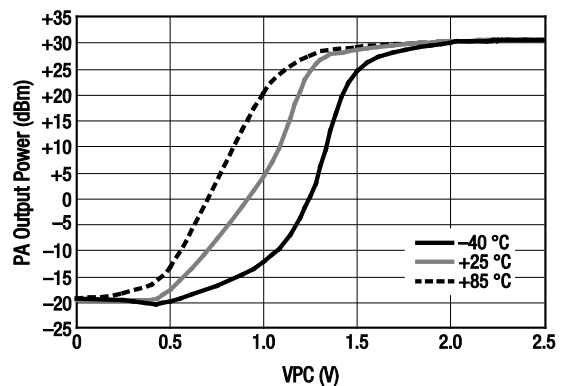
**Figure 3. PA Saturated Output Power vs Frequency Over Temperature (VCC\_TX/1/2/3 = VDD2 = 4.0 V, VDD1 = VCC\_RX = 3.3 V, P<sub>IN</sub> = +10 dBm, VPC = 2.25 V)**



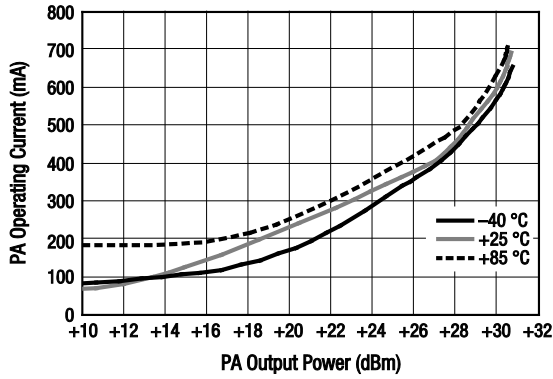
**Figure 4. PA Saturated Output Power vs Frequency Over VCC\_TX/1/2/3 (VDD1 = VCC\_RX = 3.3 V, Tc = 25 °C, P<sub>IN</sub> = +10 dBm, VPC = 2.25 V)**



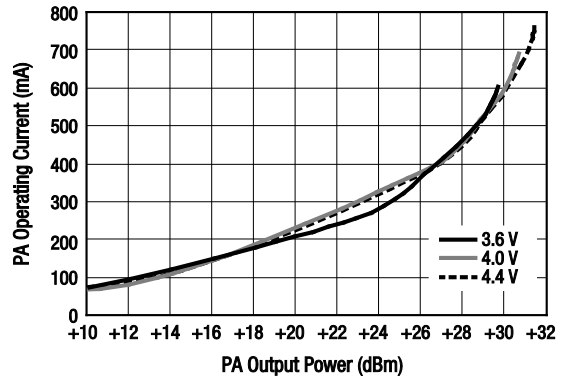
**Figure 5. PA Gain vs Output Power Over Temperature (VCC\_TX/1/2/3 = VDD2 = 4.0 V, VDD1 = VCC\_RX = 3.3 V, f = 915 MHz, VPC = 2.25 V)**



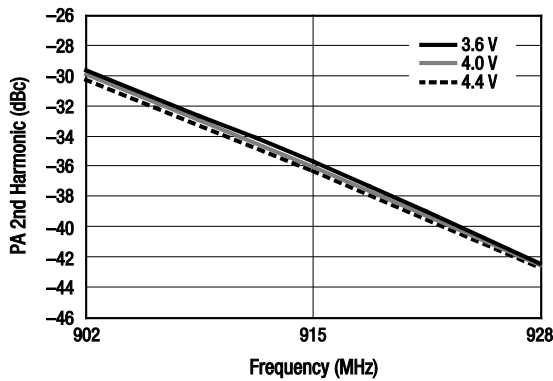
**Figure 6. PA Output Power vs VPC Over Temperature (VCC\_TX/1/2/3 = VDD2 = 4.0 V, VDD1 = VCC\_RX = 3.3 V, f = 915 MHz, P<sub>IN</sub> = +10 dBm)**



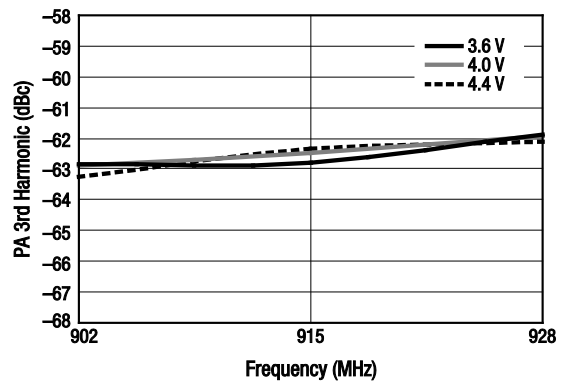
**Figure 7. PA Operating Current vs Output Power Over Temperature (VCC\_TX1/2/3 = VDD2 = 4.0 V, VDD1 = VCC\_RX = 3.3 V, f = 915 MHz, VPC = 2.25 V)**



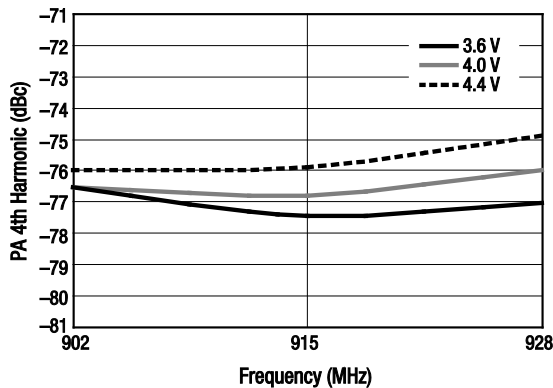
**Figure 8. PA Operating Current vs Output Power Over VCC\_TX1/2/3 (VDD1 = VCC\_RX = 3.3 V, Tc = 25 °C, f = 915 MHz, VPC = 2.25 V)**



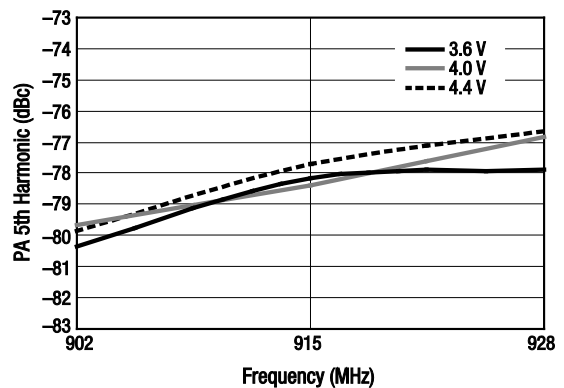
**Figure 9. PA 2<sup>nd</sup> Harmonic vs Frequency Over VCC\_TX1/2/3 (VDD1 = VCC\_RX = 3.3 V, Tc = 25 °C, P<sub>IN</sub> = +10 dBm VPC = 2.25 V)**



**Figure 10. PA 3<sup>rd</sup> Harmonic vs Frequency Over VCC\_TX1/2/3 (VDD1 = VCC\_RX = 3.3 V, Tc = 25 °C, P<sub>IN</sub> = +10 dBm VPC = 2.25 V)**

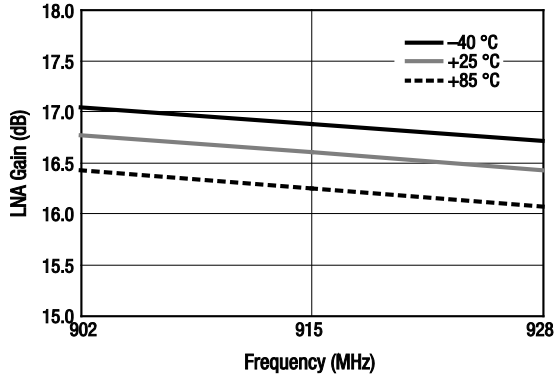


**Figure 11. PA 4<sup>th</sup> Harmonic vs Frequency Over VCC\_TX1/2/3 (VDD1 = VCC\_RX = 3.3 V, Tc = 25 °C, P<sub>IN</sub> = +10 dBm VPC = 2.25 V)**

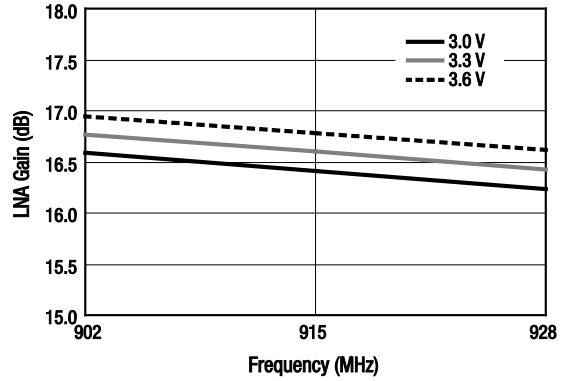


**Figure 12. PA 5<sup>th</sup> Harmonic vs Frequency Over VCC\_TX1/2/3 (VDD1 = VCC\_RX = 3.3 V, Tc = 25 °C, P<sub>IN</sub> = +10 dBm VPC = 2.25 V)**

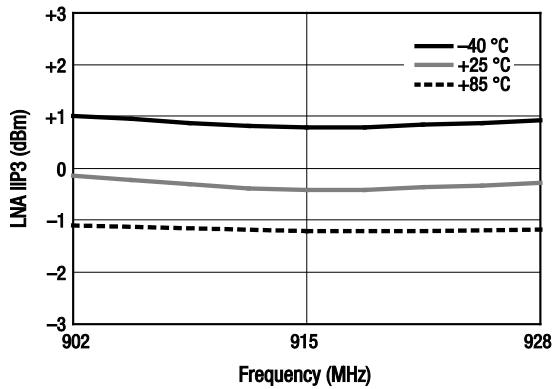




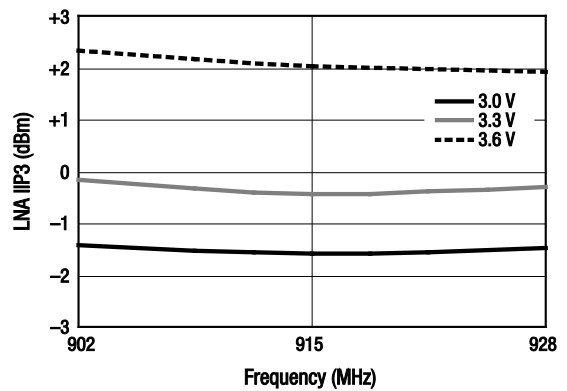
**Figure 13. LNA Gain vs Frequency Over Temperature**  
(VCC\_TX/1/2/3 = VDD2 = 4.0 V, VDD1 = VCC\_RX = 3.3 V)



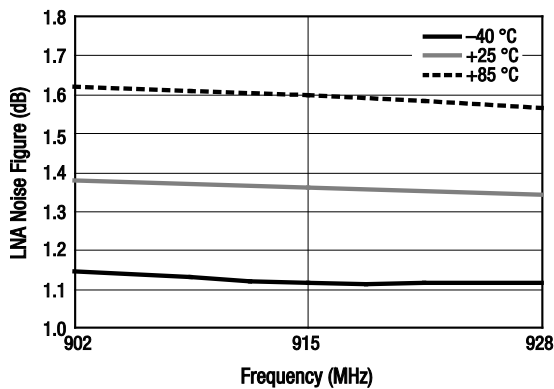
**Figure 14. LNA Gain vs Frequency Over VCC\_RX**  
(VCC\_TX/1/2/3 = VDD2 = 4.0 V, Tc = 25 °C)



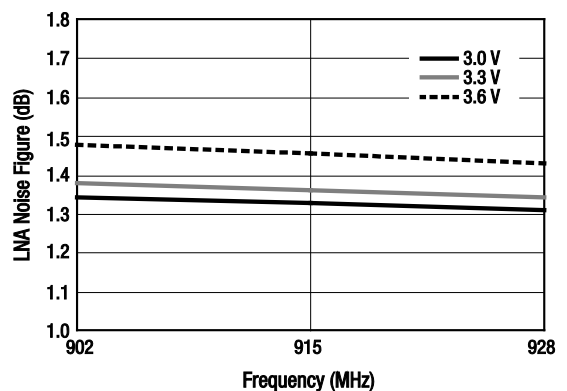
**Figure 15. LNA IIP3 vs Frequency Over Temperature**  
(VCC\_TX/1/2/3 = VDD2 = 4.0 V, Tc = 25 °C)



**Figure 16. LNA IIP3 vs Frequency Over VCC\_RX**  
(VCC\_TX/1/2/3 = VDD2 = 4.0 V, Tc = 25 °C)



**Figure 17. LNA Noise Figure vs Frequency Over Temperature**  
(VCC\_TX/1/2/3 = VDD2 = 4.0 V, VCC\_RX = VDD1 = 3.3 V)



**Figure 18. LNA Noise Figure vs Frequency Over VCC\_RX**  
(VCC\_TX/1/2/3 = VDD2 = 4.0 V, Tc = 25 °C)

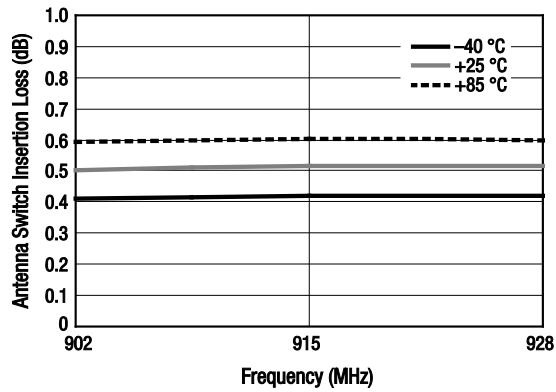


Figure 19. Antenna Switch Insertion Loss vs Frequency Over Temperature (VCC\_TX/1/2/3 = VDD2 = 4.0 V, VDD1 = VCC\_RX = 3.3 V)

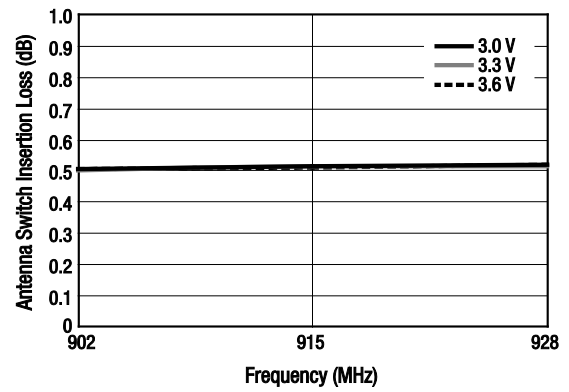


Figure 20. Antenna Switch Insertion Loss vs Frequency Over VCC\_RX (VCC\_TX/1/2/3 = VDD2 = 4.0 V, Tc = 25 °C)

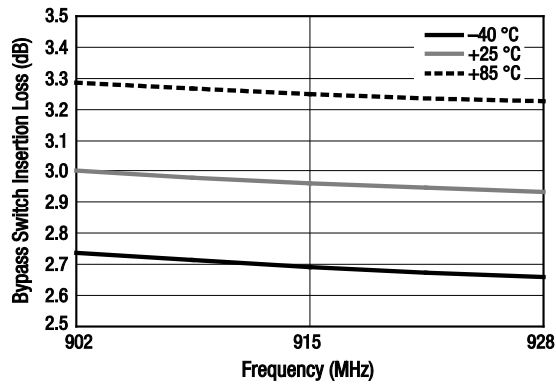


Figure 21. Bypass Switch Insertion Loss vs Frequency Over Temperature (VCC\_TX/1/2/3 = VDD2 = 4.0 V, Tc = 25 °C)

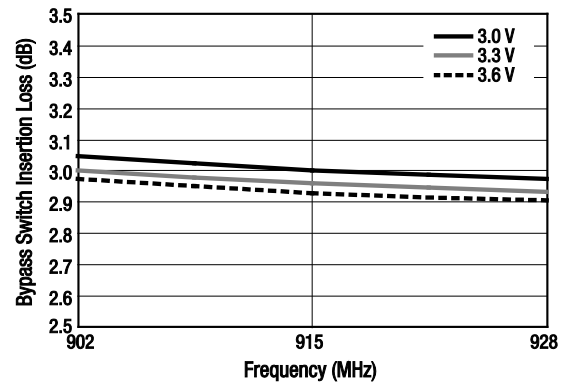


Figure 22. Bypass Switch Insertion Loss vs Frequency Over VCC\_RX (VCC\_TX/1/2/3 = VDD2 = 4.0 V, Tc = 25 °C)

### Evaluation Board Description

The SKY65313-21 Evaluation Board is used to test the performance of the SKY65313-21 T/R FEM. A typical application schematic diagram is provided in Figure 23. An Evaluation Board schematic diagram is provided in Figure 24. An assembly drawing for the Evaluation Board is shown in Figure 25.

### Package Dimensions

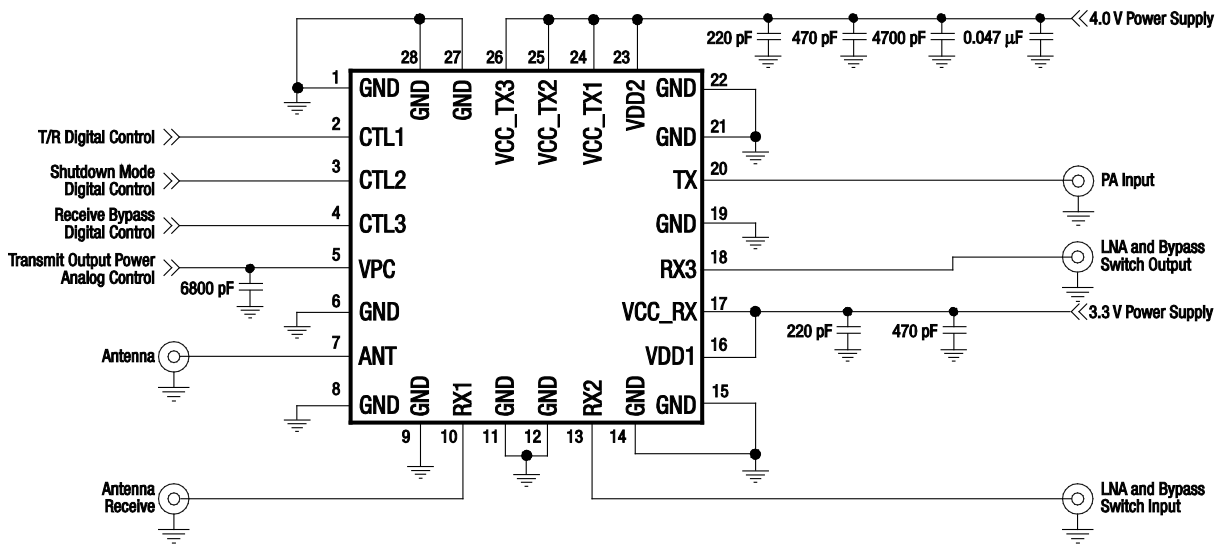
The PCB layout footprint for the SKY65313-21 is provided in Figure 26. Package dimensions for the 28-pin MCM are shown in Figure 27, and tape and reel dimensions are provided in Figure 28.

### Package and Handling Information

Since the device package is sensitive to moisture absorption, it is baked and vacuum packed before shipping. Instructions on the shipping container label regarding exposure to moisture after the container seal is broken must be followed. Otherwise, problems related to moisture absorption may occur when the part is subjected to high temperature during solder assembly.

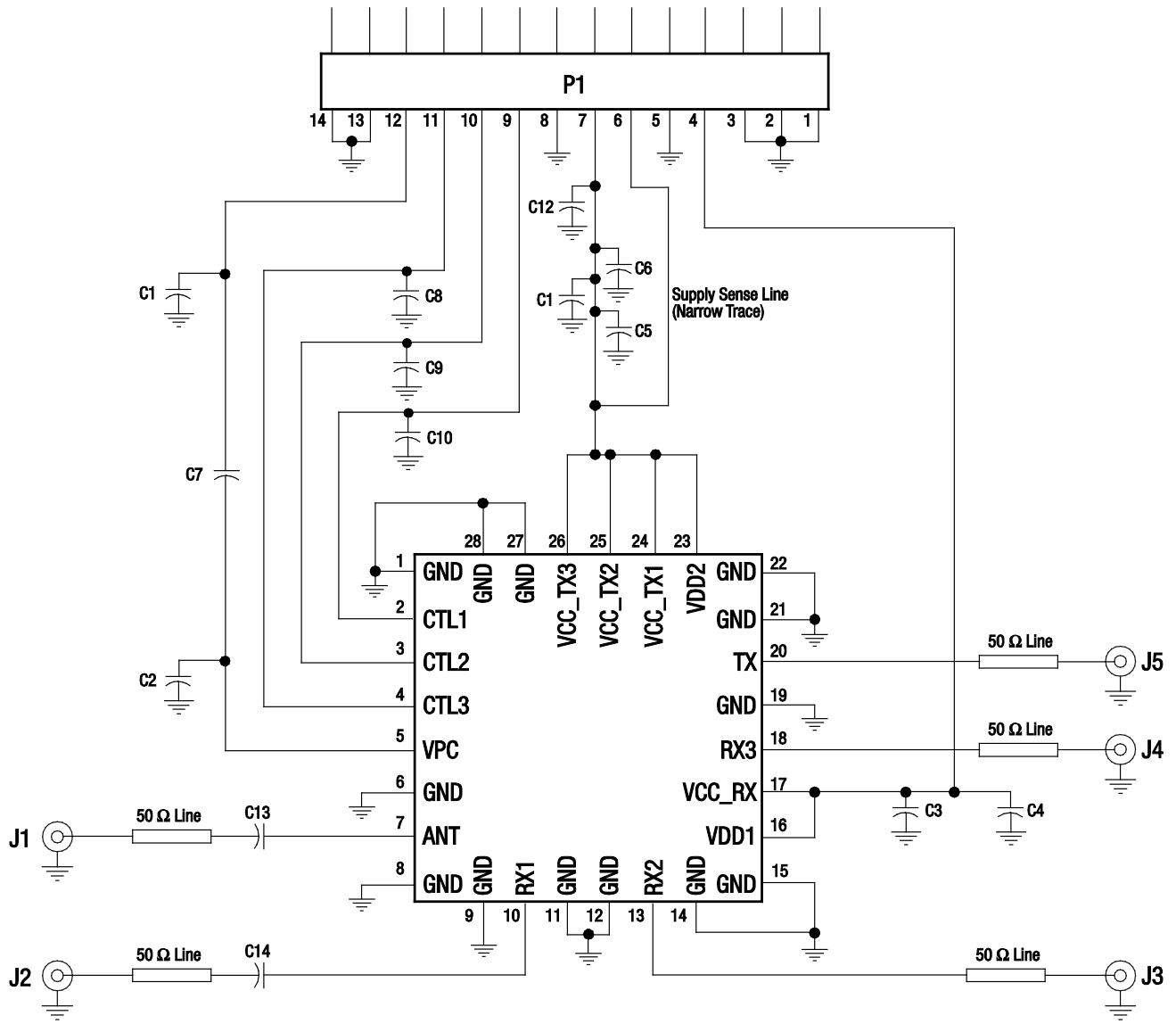
The SKY65313-21 is rated to Moisture Sensitivity Level 3 (MSL3) at 260 °C. It can be used for lead or lead-free soldering. For additional information, refer to Skyworks Application Note, *PCB Design and SMT Assembly/Rework Guidelines for MCM-L Packages*, document number 101752.

Care must be taken when attaching this product, whether it is done manually or in a production solder reflow environment. Production quantities of this product are shipped in a standard tape and reel format.



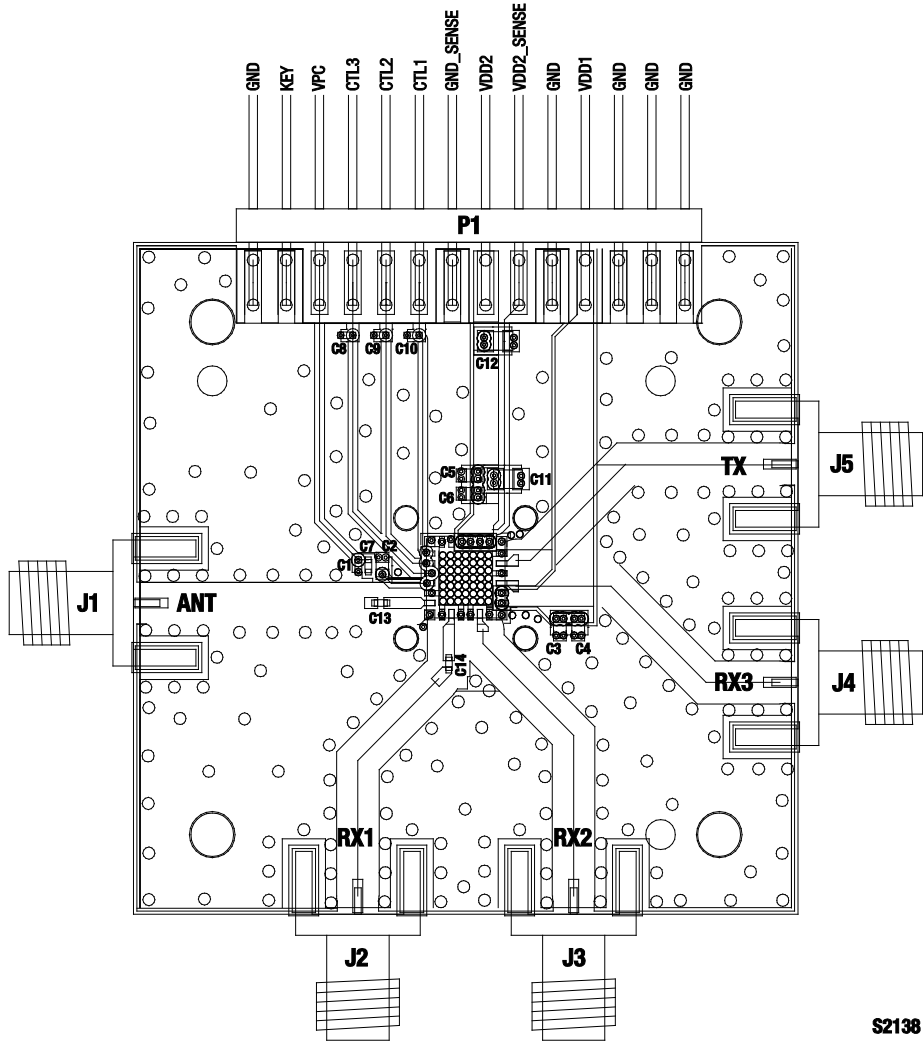
S2127

Figure 23. SKY65313-21 Typical Application Schematic



S2139

Figure 24. SKY65313-21 Evaluation Board Schematic



S2138

Figure 25. SKY65313-21 Evaluation Board Assembly Diagram

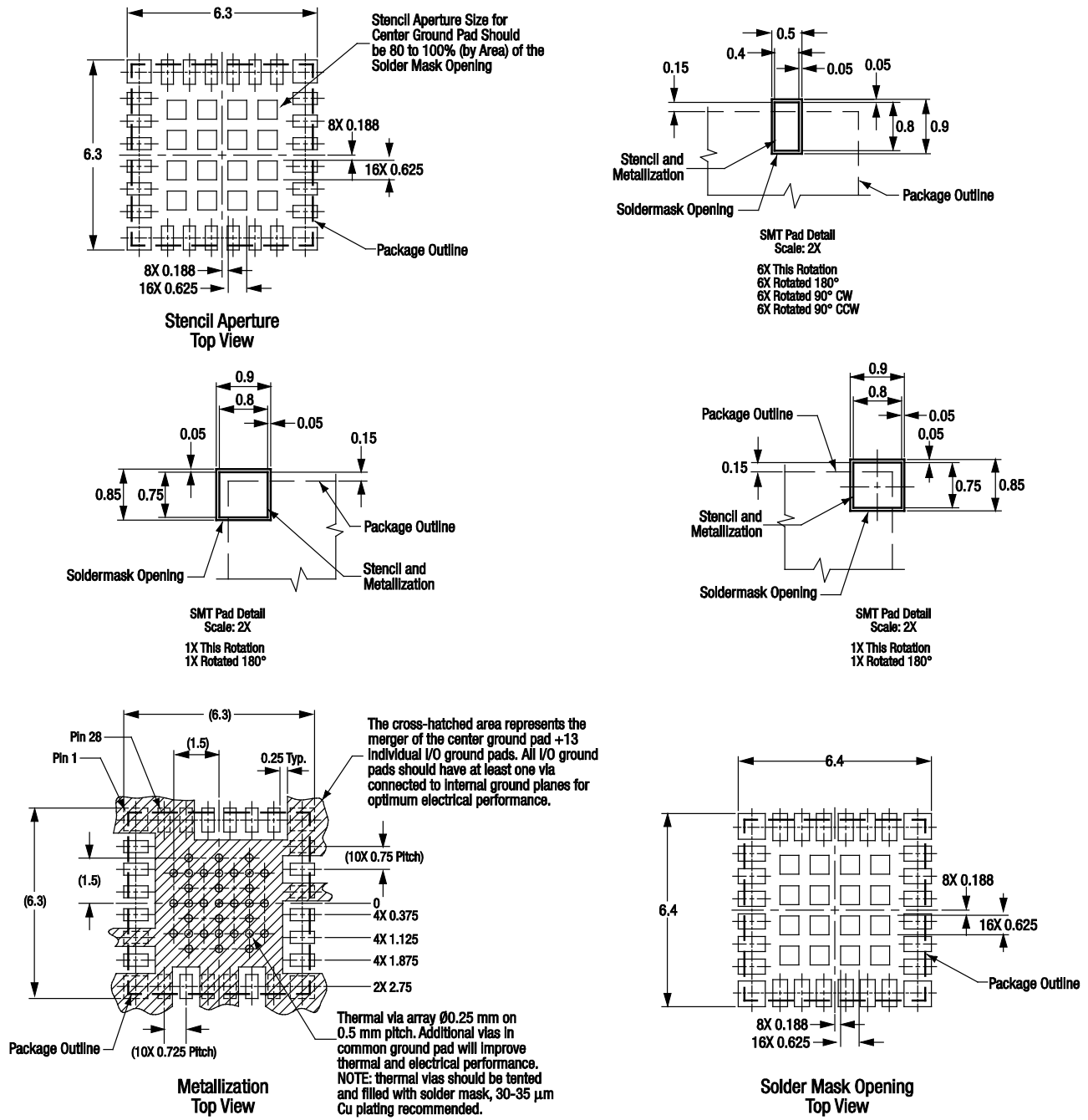
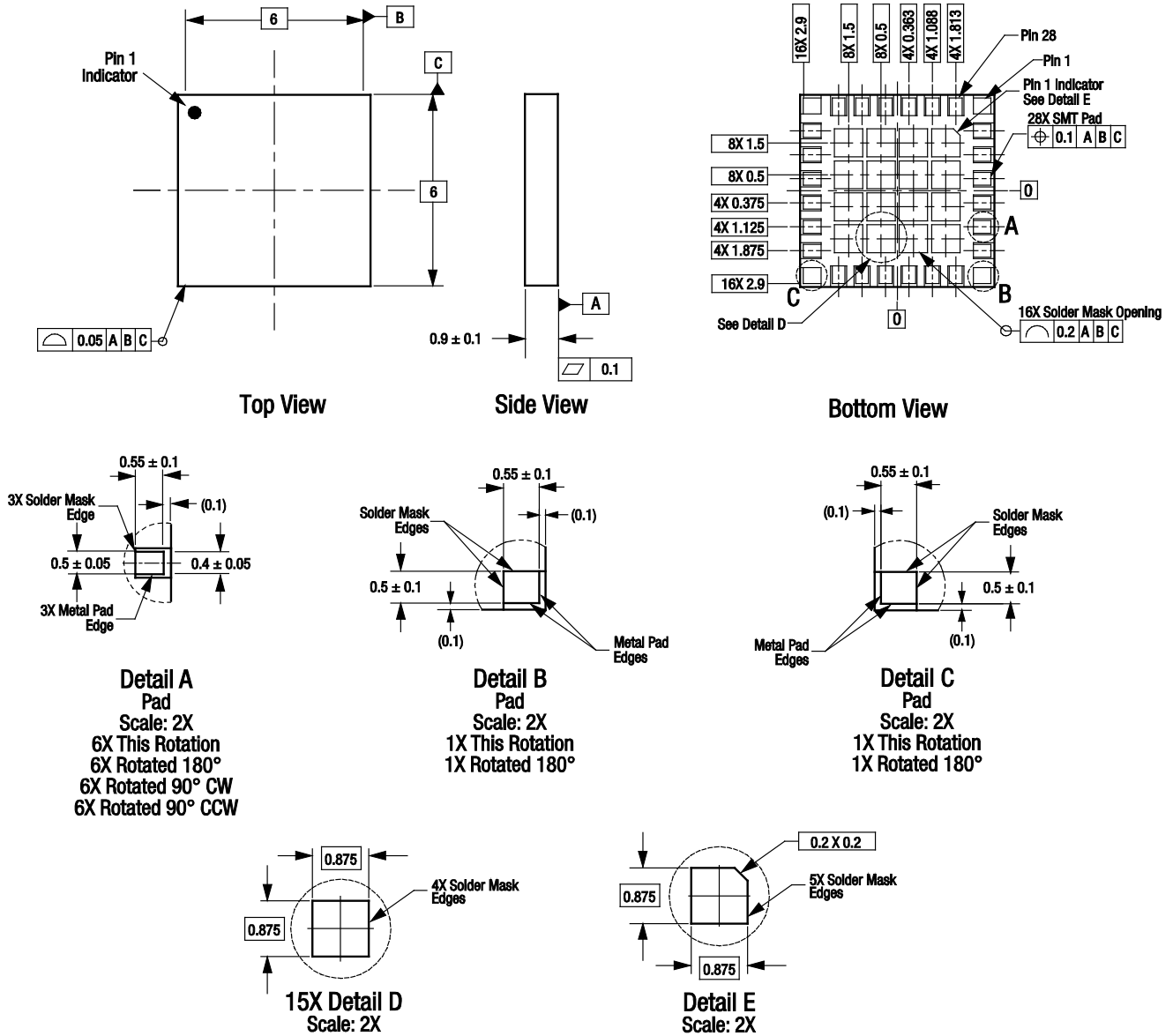


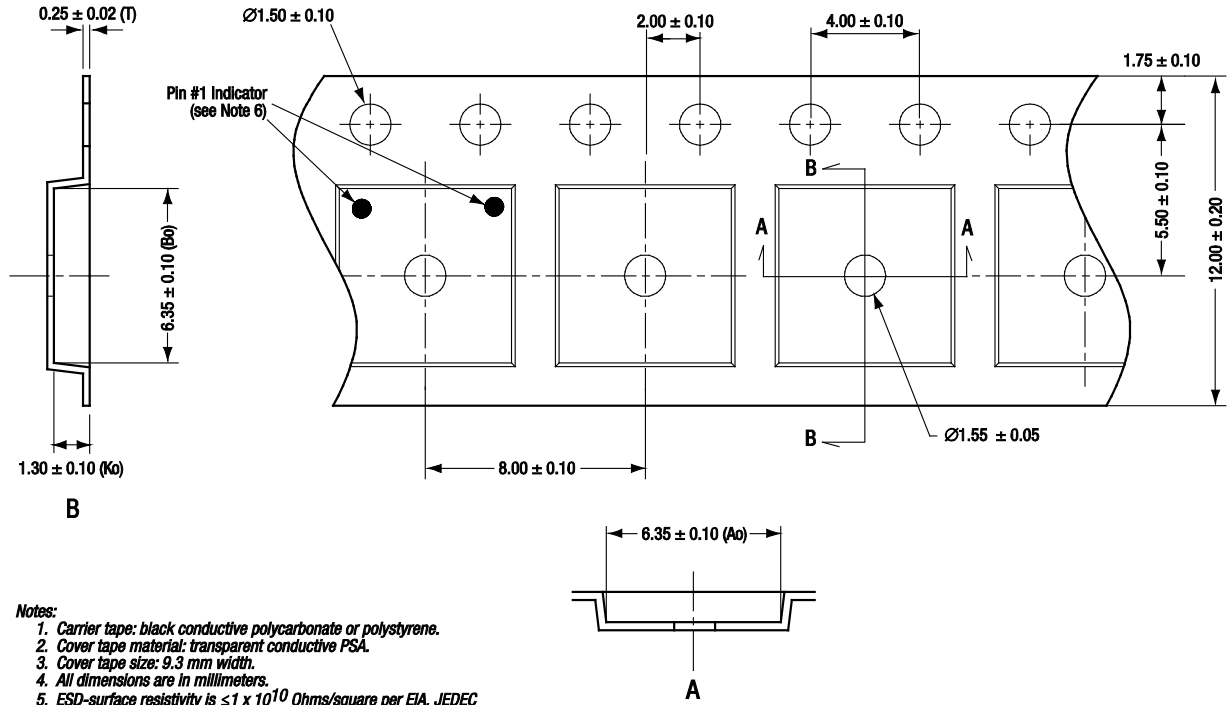
Figure 26. SKY65313-21 PCB Layout Footprint



All measurements are in millimeters.  
Dimensioning and tolerancing according to ASME Y14.5M-1994.

S2125

Figure 27. SKY65313-21 28-Pin MCM Package Dimensions



- Notes:
1. Carrier tape: black conductive polycarbonate or polystyrene.
  2. Cover tape material: transparent conductive PSA.
  3. Cover tape size: 9.3 mm width.
  4. All dimensions are in millimeters.
  5. ESD-surface resistivity is  $\leq 1 \times 10^{10}$  Ohms/square per EIA, JEDEC TNR Specification.
  6. Pin 1 orientation is in top left corner for the following Skyworks products:

SKY73022-21, -31  
SKY73023-21, -31

For all other 6 x 6 mm MCM/RFLGA products, pin 1 orientation is in top right corner.

S1850

Figure 28. SKY65313-21 28-Pin MCM Tape and Reel Dimensions



**Ordering Information**

Model Name	Manufacturing Part Number	Evaluation Board Part Number
SKY65313-21 T/R Front-End Module	SKY65313-21	TW21-D300

Copyright © 2012 Skyworks Solutions, Inc. All Rights Reserved.

Information in this document is provided in connection with Skyworks Solutions, Inc. (“Skyworks”) products or services. These materials, including the information contained herein, are provided by Skyworks as a service to its customers and may be used for informational purposes only by the customer. Skyworks assumes no responsibility for errors or omissions in these materials or the information contained herein. Skyworks may change its documentation, products, services, specifications or product descriptions at any time, without notice. Skyworks makes no commitment to update the materials or information and shall have no responsibility whatsoever for conflicts, incompatibilities, or other difficulties arising from any future changes.

No license, whether express, implied, by estoppel or otherwise, is granted to any intellectual property rights by this document. Skyworks assumes no liability for any materials, products or information provided hereunder, including the sale, distribution, reproduction or use of Skyworks products, information or materials, except as may be provided in Skyworks Terms and Conditions of Sale.

THE MATERIALS, PRODUCTS AND INFORMATION ARE PROVIDED “AS IS” WITHOUT WARRANTY OF ANY KIND, WHETHER EXPRESS, IMPLIED, STATUTORY, OR OTHERWISE, INCLUDING FITNESS FOR A PARTICULAR PURPOSE OR USE, MERCHANTABILITY, PERFORMANCE, QUALITY OR NON-INFRINGEMENT OF ANY INTELLECTUAL PROPERTY RIGHT; ALL SUCH WARRANTIES ARE HEREBY EXPRESSLY DISCLAIMED. SKYWORKS DOES NOT WARRANT THE ACCURACY OR COMPLETENESS OF THE INFORMATION, TEXT, GRAPHICS OR OTHER ITEMS CONTAINED WITHIN THESE MATERIALS. SKYWORKS SHALL NOT BE LIABLE FOR ANY DAMAGES, INCLUDING BUT NOT LIMITED TO ANY SPECIAL, INDIRECT, INCIDENTAL, STATUTORY, OR CONSEQUENTIAL DAMAGES, INCLUDING WITHOUT LIMITATION, LOST REVENUES OR LOST PROFITS THAT MAY RESULT FROM THE USE OF THE MATERIALS OR INFORMATION, WHETHER OR NOT THE RECIPIENT OF MATERIALS HAS BEEN ADVISED OF THE POSSIBILITY OF SUCH DAMAGE.

Skyworks products are not intended for use in medical, lifesaving or life-sustaining applications, or other equipment in which the failure of the Skyworks products could lead to personal injury, death, physical or environmental damage. Skyworks customers using or selling Skyworks products for use in such applications do so at their own risk and agree to fully indemnify Skyworks for any damages resulting from such improper use or sale.

Customers are responsible for their products and applications using Skyworks products, which may deviate from published specifications as a result of design defects, errors, or operation of products outside of published parameters or design specifications. Customers should include design and operating safeguards to minimize these and other risks. Skyworks assumes no liability for applications assistance, customer product design, or damage to any equipment resulting from the use of Skyworks products outside of stated published specifications or parameters.

Skyworks, the Skyworks symbol, and “Breakthrough Simplicity” are trademarks or registered trademarks of Skyworks Solutions, Inc., in the United States and other countries. Third-party brands and names are for identification purposes only, and are the property of their respective owners. Additional information, including relevant terms and conditions, posted at [www.skyworksinc.com](http://www.skyworksinc.com), are incorporated by reference.