

DATA SHEET

SKY66288-11: 5150 to 5925 MHz High-Efficiency 4 W Power Amplifier

Applications

- LTE small cell applications for Band 46
- LTE advanced for unlicensed spectrum, LAA, and LTE-U
- Driver amplifier for micro-base and macro-base stations
- Active antenna array and massive MIMO

Features

- High efficiency: PAE = 25% @ +28 dBm
- High linearity: +28 dBm with < -50 dBc ACLR with pre-distortion (2x 20 MHz LTE)
- Gain @+28 dBm output power: 34.5 dB
- Excellent input and output return loss: to 50 Ω system
- Integrated active bias: performance compensated over temp
- Integrated enable On/Off function: PAEN = 1.7 to 2.5 V
- Single supply voltage: 5.0 V
- Pin-to-pin compatible PA family supporting all 3GPP bands
- Compact (16-pin, 5 × 5 × 1.3 mm) package (MSL3, 260 °C per JEDEC J-STD-020)



Skyworks Green™ products are compliant with all applicable legislation and are halogen-free. For additional information, refer to *Skyworks Definition of Green™*, document number SQ04-0074.

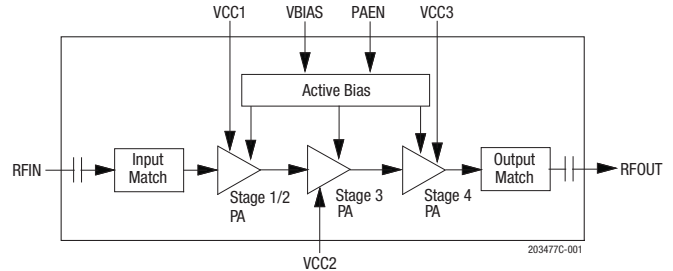

Figure 1. SKY66288-11 Block Diagram

Description

The SKY66288-11 is a high-efficiency fully input/output matched power amplifier (PA) with high gain and linearity. The compact 5 × 5 mm PA is designed for the unlicensed spectrum, LTE-advanced small cell base stations operating from 5150 to 5925 MHz. The active biasing circuitry is integrated to compensate PA performance over temperature, voltage, and process variation.

The SKY66288-11 is part of the high-efficiency, pin-to-pin compatible PA family supporting all 3GPP bands.

A block diagram of the SKY66288-11 is shown in Figure 1. The device package and pinout for the 16-pin device are shown in Figure 2. Table 1 lists the pin-to-pin compatible parts in the PA family. Signal pin assignments and functional pin descriptions are described in Table 2.

Table 1. Pin-to-Pin Compatible PA Family

Part Number	Frequency (MHz)	3GPP Band
SKY66296-11	700 to 800	Bands 12, 13, 14, 17, 29, and 44
SKY66289-11	791 to 821	Band 20
SKY66295-11	800 to 900	Bands 5, 18, 19, 26 and 27
SKY66298-11	900 to 990	Band 8
SKY66291-11	1805 to 1880	Bands 3 and 9
SKY66299-11	1900 to 2000	Bands 2, 25, 33, 36, and 37
SKY66294-11	2000 to 2300	Bands 1, 4, 10, and 23
SKY66292-11	2300 to 2400	Bands 30, 40
SKY66297-11	2490 to 2690	Bands 7, 38, and 41
SKY66293-21	3400 to 3800	CBRS, Bands 22, 42, 43, and 48
SKY66288-11	5150 to 5925	Band 46, LAA, LTE-U

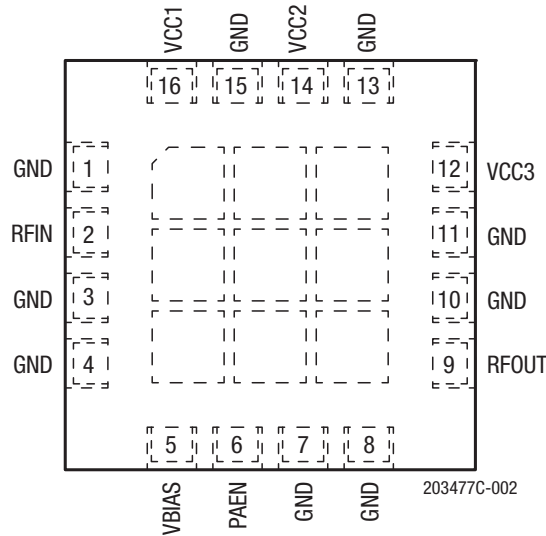

Figure 2. SKY66288-11 Pinout (Top View)

Table 2. SKY66288-11 Signal Descriptions¹

Pin	Name	Description	Pin	Name	Description
1	GND	Ground	9	RFOUT	RF output port
2	RFIN	RF input port	10	GND	Ground
3	GND	Ground	11	GND	Ground
4	GND	Ground	12	VCC3	Stage 4 collector voltage
5	VBIAS	Bias voltage	13	GND	Ground
6	PAEN	PA enable	14	VCC2	Stage 3 collector voltage
7	GND	Ground	15	GND	Ground
8	GND	Ground	16	VCC1	Stage 1 and Stage 2 collector voltage

¹ The center ground pad must have a low inductance and low thermal resistance connection to the application’s printed circuit board ground plane.

Technical Description

The matching circuits are contained within the device. An on-chip active bias circuit is included within the device for both input and output stages, which provides excellent gain tracking over temperature and voltage variations.

The SKY66288-11 is internally matched for maximum output power and efficiency. The input and output stages are independently supplied using the VCC1, VCC2, and VCC3 supply lines (pins 16, 14, and 12, respectively). The DC control voltage that sets the bias is supplied by the VCBIAS signal (pin 5).

Electrical and Mechanical Specifications

The absolute maximum ratings of the SKY66288-11 are provided in Table 3. Recommended operating conditions are specified in Table 4, and electrical specifications are provided in Table 5 (5200 MHz) and Table 6 (5850 MHz).

Typical performance characteristics are shown in Figures 3 through 26.

Table 3. SKY66288-11 Absolute Maximum Ratings¹

Parameter	Symbol	Minimum	Maximum	Units
RF input power (CW)	P _{IN}		+10	dBm
Supply voltage (VCC1, VCC2, VCC3, VBIAS)	V _{CC}		5.5	V
Operating temperature	T _C	-40	+100	°C
Storage temperature	T _{ST}	-55	+125	°C
Junction temperature	T _J		+150	°C
Power dissipation	P _D		2.2	W
Device thermal resistance	θ _{JC}		25	°C/W

¹ Exposure to maximum rating conditions for extended periods may reduce device reliability. There is no damage to device with only one parameter set at the limit and all other parameters set at or below their nominal value. Exceeding any of the limits listed here may result in permanent damage to the device.

ESD HANDLING: *Although this device is designed to be as robust as possible, electrostatic discharge (ESD) can damage this device. This device must be protected at all times from ESD when handling or transporting. Static charges may easily produce potentials of several kilovolts on the human body or equipment, which can discharge without detection. Industry-standard ESD handling precautions should be used at all times.*

Table 4. SKY66288-11 Recommended Operating Conditions

Parameter	Symbol	Test Condition	Min	Typ	Max	Units
Supply voltage (VCC1, VCC2, VCC3, VBIAS)	VCC1, VCC2, VCC3, VBIAS		4.75	5	5.25	V
PA enable:	PAEN					
ON			1.7	2.0	2.5	V
OFF				0	0.5	V
PA enable current	I _{ENABLE}			1	12	μA
Operating frequency (CW, TCASE = +85 °C)	f		5150		5925	MHz
Operating temperature (CW, TCASE = +85 °C)	T _C		-40	+25	+85	°C
RF turn-on/turn-off time (CW, TCASE = +85 °C)		On time: 50% of PAen voltage to 90% of RF power Off Time: 50% of PAen voltage to 10% of RF power		1.5	5	us

Table 5. SKY66288-11 Electrical Specifications¹

(Vcc1 = Vcc2 = Vcc3 = VBIAS = 5 V, PAEN = 2.0 V, f = 5200 MHz, Tc = +25 °C, Input/Output Load = 50 Ω, Unless Otherwise Noted)

Parameter	Symbol	Test Condition	Min	Typ	Max	Units
Small signal gain	IS21I	PIN = -30 dBm		33.5		dB
Gain @+28 dBm	Gain@+28dBm	POUT = +28 dBm	33	35		dB
Input return loss	IS11I	PIN = -30 dBm	6.5	8		dB
Output return loss	IS22I	PIN = -30 dBm	8	9		dB
Reverse isolation ²	IS12I	PIN = -30 dBm		50		dB
ACLR @ +28 dBm	ACLR	POUT = +28 dBm (20 MHz LTE, 8.5 dB PAR signal)		-32	-28	dBc
ACLR 2C @ +28 dBm ²	ACLR 2C	POUT = +28 dBm (2x20 MHz LTE, 8.5 dB PAR signal)		-30		dBc
Saturated output power ²	PSAT	CW, PIN = 8 dBm		+36		dBm
Output power at 3dB gain compression	P3dB	CW, reference to small signal gain (PIN = -30 dBm)	+34	+35		dBm
2 nd harmonic ²	2fo	CW, POUT = +28 dBm		-40		dBc
Power-added efficiency	PAE	CW, POUT = +28 dBm	22	25		%
Quiescent current	ICCQ	No RF signal		95		mA

¹ Performance is guaranteed only under the conditions listed in this table.

² Not tested in production. Verified by design.

Table 6. SKY66288-11 Electrical Specifications¹

(Vcc1 = Vcc2 = Vcc3 = VBIAS = 5 V, PAEN = 2.0 V, f = 5887.5 MHz, Tc = +25 °C, Input/Output Load = 50 Ω, Unless Otherwise Noted)

Parameter	Symbol	Test Condition	Min	Typ	Max	Units
Small signal gain	IS21I	PIN = -30 dBm		28		dB
Gain @+28 dBm	IS21I@+28dBm	POUT = +28 dBm	29	30		dB
Input return loss	IS11I	PIN = -30 dBm	9	10		dB
Output return loss	IS22I	PIN = -30 dBm	10	12		dB
Reverse isolation ²	IS12I	PIN = -30 dBm		50		dB
ACLR @ +28 dBm	ACLR	POUT = +28 dBm (20 MHz LTE, 8.5 dB PAR signal)		-33	-29.5	dBc
ACLR 2C @ +28 dBm ²	ACLR 2C	POUT = +28 dBm (2x20 MHz LTE, 8.5 dB PAR signal)		-31		dBc
Saturated output power	PSAT	CW, PIN = 8 dBm		+34		dBm
Output power at 3dB gain compression	P3dB	CW, reference to small signal gain (PIN = -30 dBm)	+32	+33.5		dBm
2 nd harmonic ²	2fo	CW, POUT = +28 dBm		-40		dBc
Power-added efficiency	PAE	CW, POUT = +28 dBm	20	24		%
Quiescent current	ICCQ	No RF signal		95		mA

¹ Performance is guaranteed only under the conditions listed in this table.

² Not tested in production. Verified by design.

Typical Performance Characteristics

(Vcc1 = Vcc2 = Vcc3 = Vbias = 5 V, PAEN = 2.0 V, Tc = +25 °C, Input/Output Load = 50 Ω, Unless Otherwise Noted)

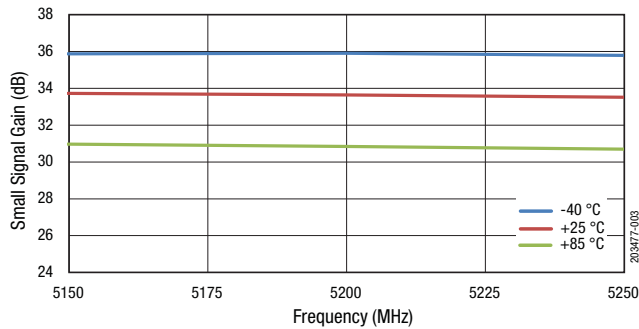

Figure 3. Small Signal Gain @ Low Band (PIN = -30 dB)

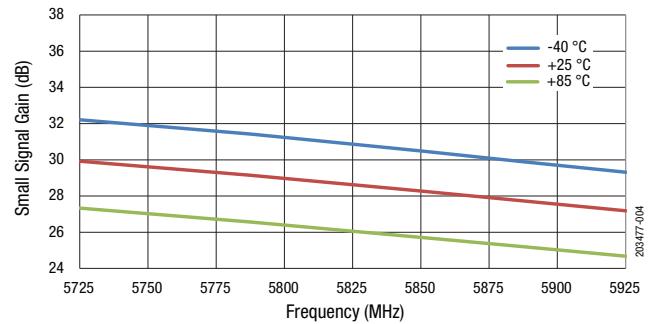

Figure 4. Small Signal Gain @ High Band (PIN = -30 dB)

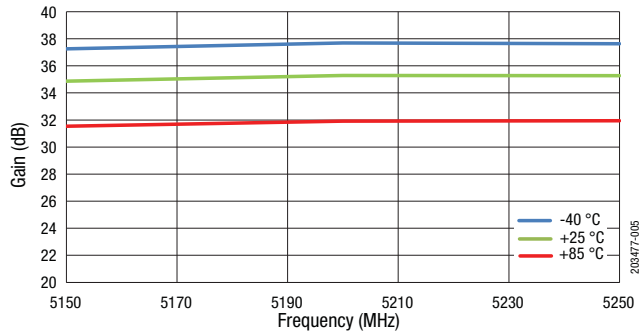

Figure 5. Large Signal Gain @ Low Band (POUT = +28 dBm, CW)

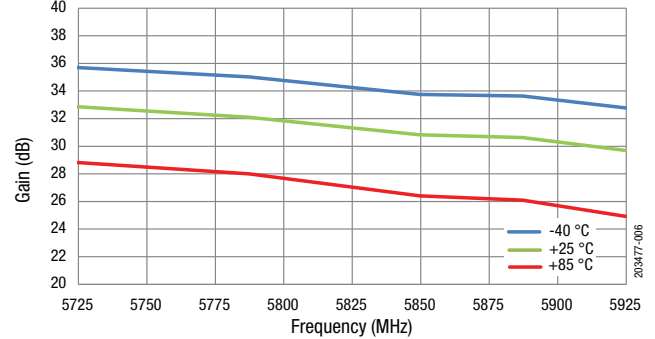

Figure 6. Large Signal Gain @ High Band (POUT = +28 dBm, CW)

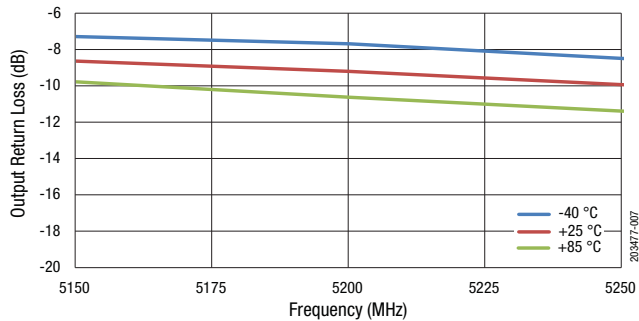

Figure 7. Output Return Loss @ Low Band (PIN = -30 dB)

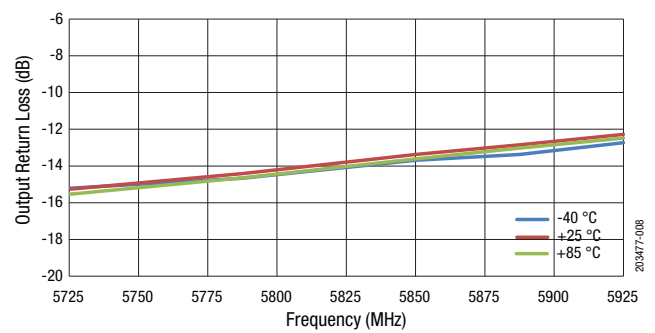

Figure 8. Output Return Loss @ High Band (PIN = -30 dB)

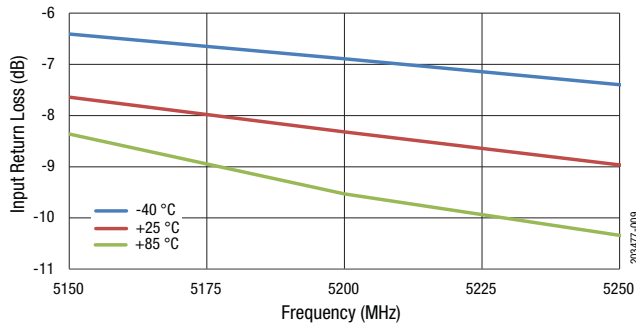

Figure 9. Input Return Loss @ Low Band (PIN = -30 dB)

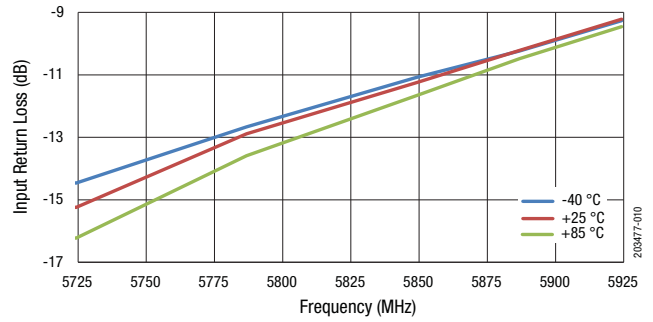

Figure 10. Input Return Loss @ High Band (PIN = -30 dB)

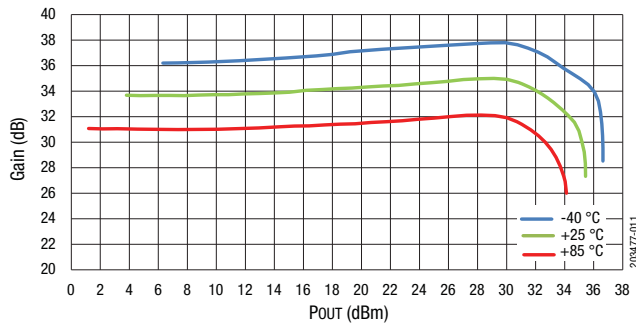

Figure 11. Gain vs Output Power @ 5200 MHz

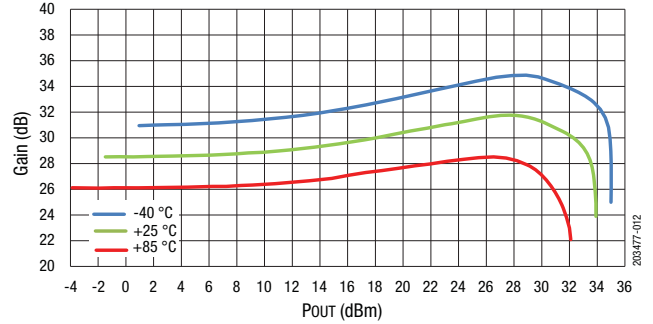

Figure 12. Gain vs Output Power @ 5787.5 MHz

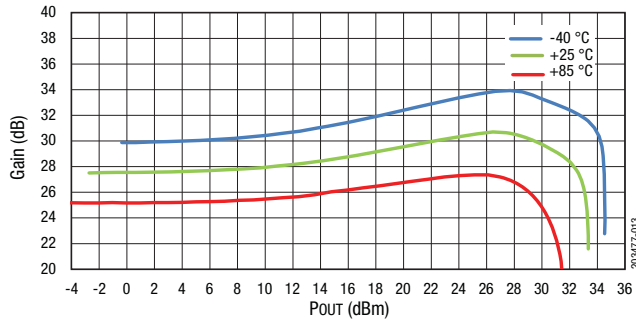

Figure 13. Gain vs Output Power @ 5887.5 MHz

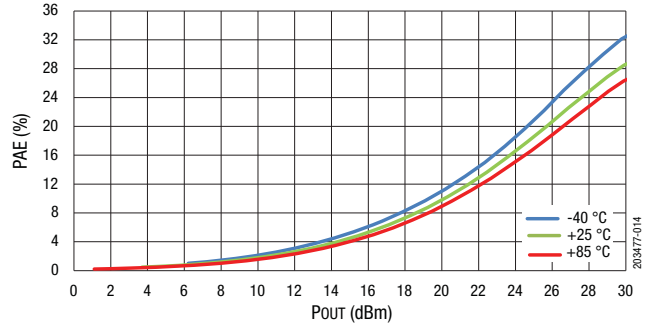

Figure 14. Power-Added Efficiency vs Output Power @ 5200 MHz

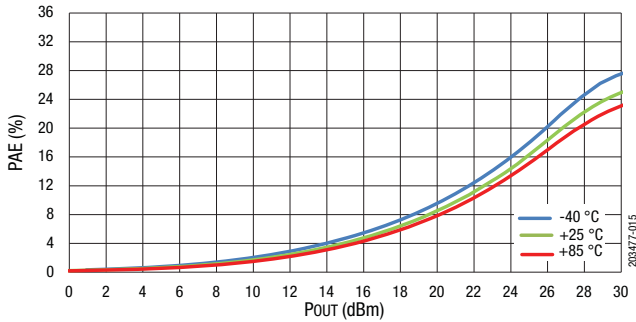

Figure 15. Power-Added Efficiency vs Output Power @ 5787.5 MHz

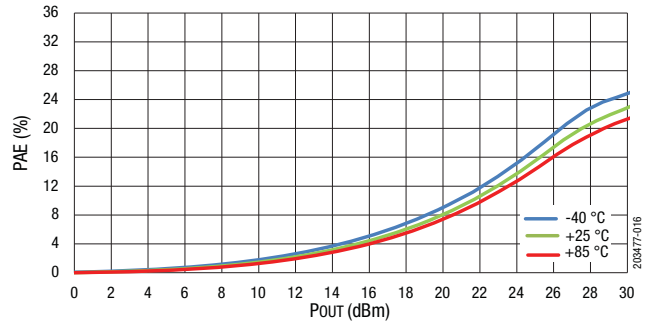

Figure 16. Power-Added Efficiency vs Output Power @ 5887.5 MHz

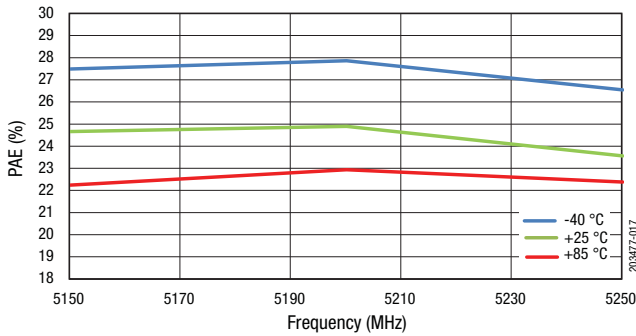

Figure 17. PAE @ POUT = +28dBm (CW) vs. Low Band Freq. over Temperature

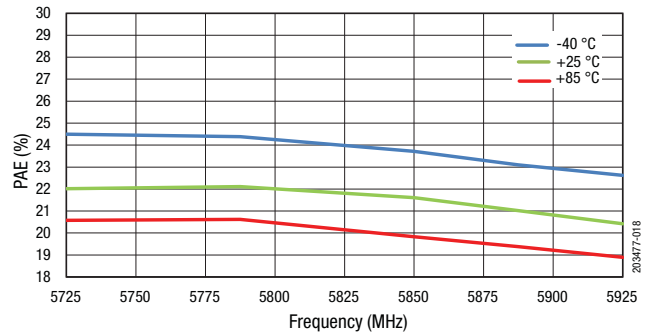

Figure 18. PAE @ POUT = +28dBm (CW) vs. High Band Freq. over Temperature

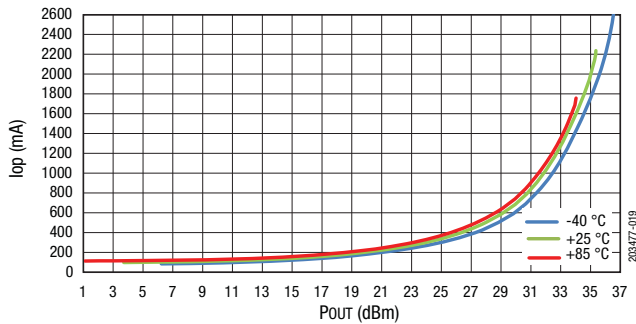

Figure 19. Total Current vs Output Power @ 5200 MHz

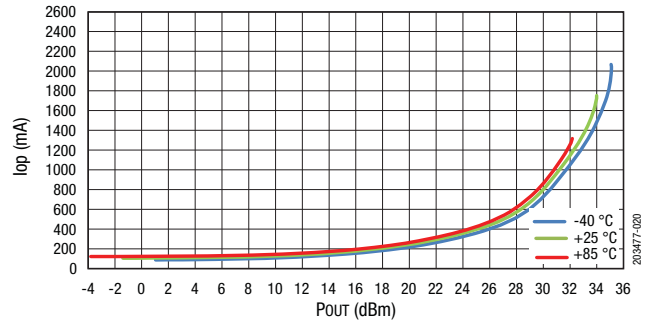

Figure 20. Total Current vs Output Power @ 5787.5 MHz

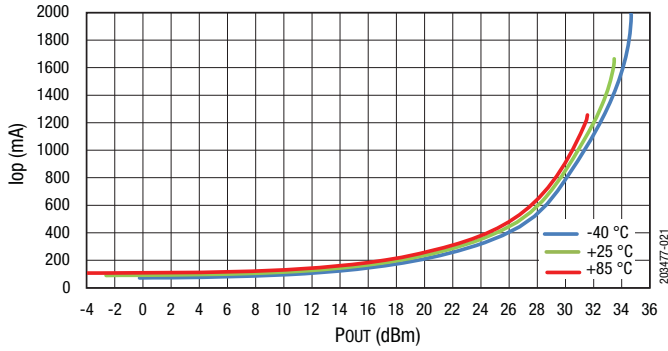

Figure 21. Total Current vs Output Power @ 5887.5 MHz

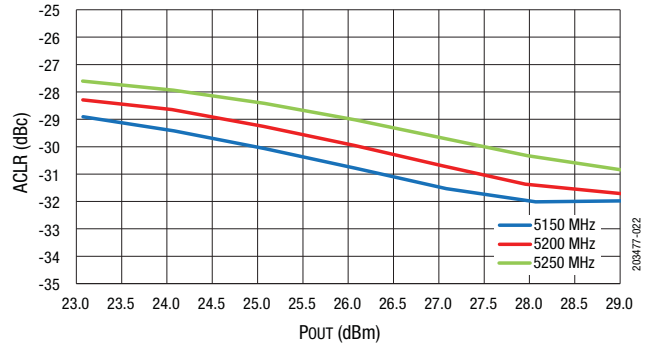

Figure 22. ACLR vs. Output Power for Low Band (LTE, 1x20 MHz, PAR = 8.5 dB)

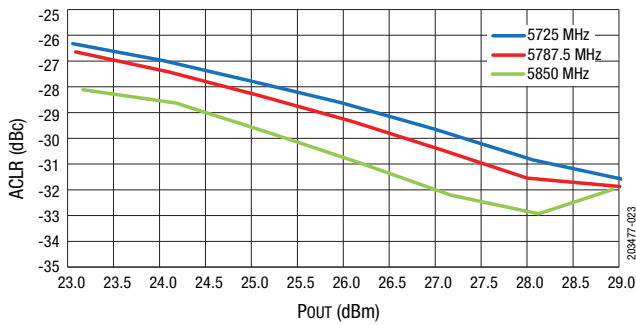

Figure 23. ACLR vs. Output Power for Mid Band (LTE, 1x20 MHz, PAR = 8.5dB)

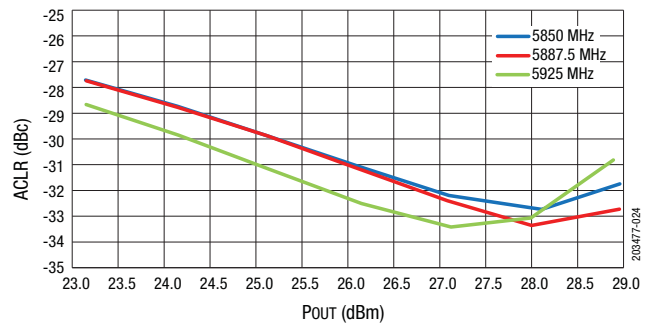

Figure 24. ACLR vs. Output Power for High Band (LTE, 1x20 MHz, PAR = 8.5dB)

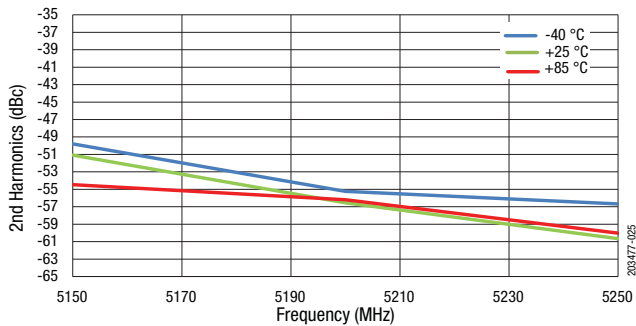

Figure 25. Second Harmonic @ Pout = +28dBm (Low Band, CW)

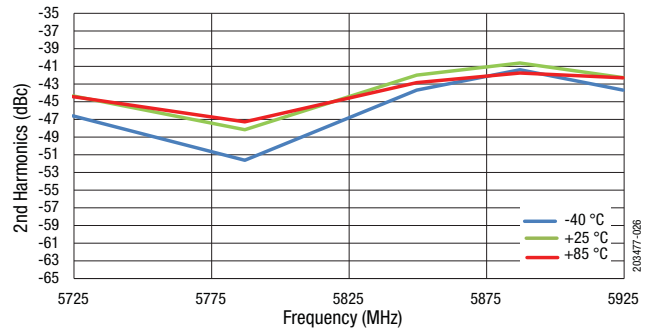

Figure 26. Second Harmonic @ Pout = +28dBm (Low Band, CW)

Evaluation Board Description

The SKY66288-11 Evaluation Board is used to test the performance of the SKY66288-11 PA. An Evaluation Board schematic is provided in Figure 27. Table 7 provides the Bill of Materials (BOM) list for Evaluation Board components.

An assembly drawing for the Evaluation Board is shown in Figure 28. Board layer details are shown in Figure 29. Layer detail physical characteristics are noted in Figure 30.

Circuit Design Considerations

The following design considerations are general in nature and must be followed regardless of final use or configuration:

- Paths to ground should be made as short as possible.
- The ground pad of the SKY66288-11 has special electrical and thermal grounding requirements. This pad is the main thermal conduit for heat dissipation. Because the circuit board acts as the heat sink, it must shunt as much heat as possible from the device.

Therefore, design the connection to the ground pad to dissipate the maximum wattage produced by the circuit board. Multiple vias to the grounding layer are required.

NOTE: A poor connection between the ground pad and ground increases junction temperature (T_J), which reduces the life of the device.

Evaluation Board Test Procedure

Turn-On Sequence

1. Connect 50 Ω Test Equipment or Load to the input and output RF ports of the Evaluation Board.
2. Connect the DC ground.
3. Connect all VCCs and VBIAS lines to a +5 V supply. Connect PAEN to a 2.0 V supply.
4. Without applying RF, turn on the 5 V supply, then turn on the 2 V PAEN.
5. Apply RF signal data at –30 dBm and observe that the gain of the device is approximately 34.5 dB. Begin measurements.

Turn-Off Sequence

1. Turn off the RF input to the device.
2. Turn off PAEN (set to 0 V).
3. Turn off all VCCs and VBIAS.

NOTE: It is important to adjust the VCC voltage sources so that +5 V is measured at the board. High collector currents drop the collector voltage significantly if long leads are used. Adjust the bias voltage to compensate.

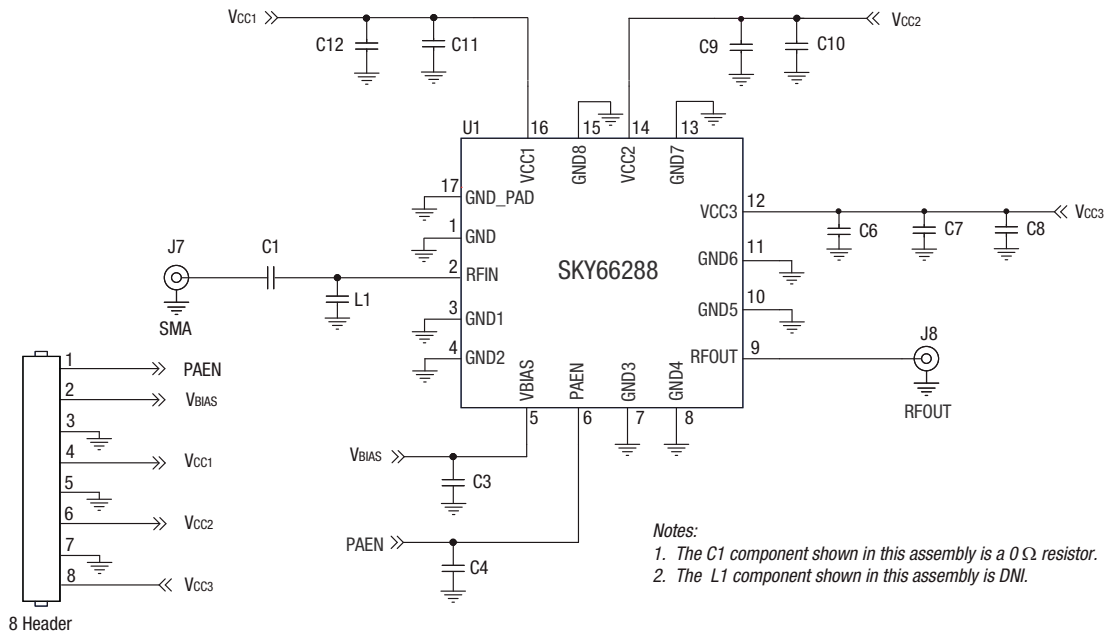
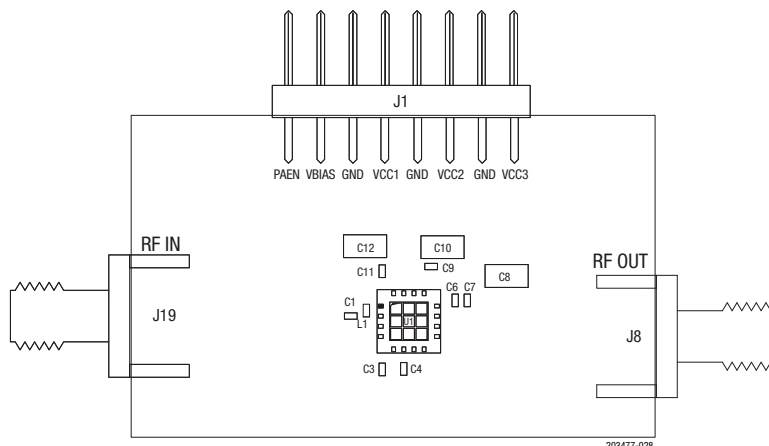

Figure 27. SKY66288-11 Evaluation Board Schematic

Table 7. SKY66288-11 Evaluation Board Bill of Materials (BOM)

Component	Description	Size
C1	Resistor, 0 Ω, 0.063 W	0402
C3	Ceramic capacitor, 1 μF, 16 V, ±10%	0402
C4, C7, C9, C11	Ceramic capacitor, 3300 pF, X7R, ±10%, 50 V	0402
C6	Ceramic capacitor, 100 pF	0402
C8, C10, C12	Ceramic capacitor, 10 μF, 16 V, ±10% , X7R	1206
L1	DNI	DNI



Notes:
 1. Evaluation Board Gerber files are available on request.
 2. The C1 component shown in this assembly is a 0 Ω resistor.
 3. The L1 component shown in this assembly is DNI.

Figure 28. Evaluation Board Assembly Drawing

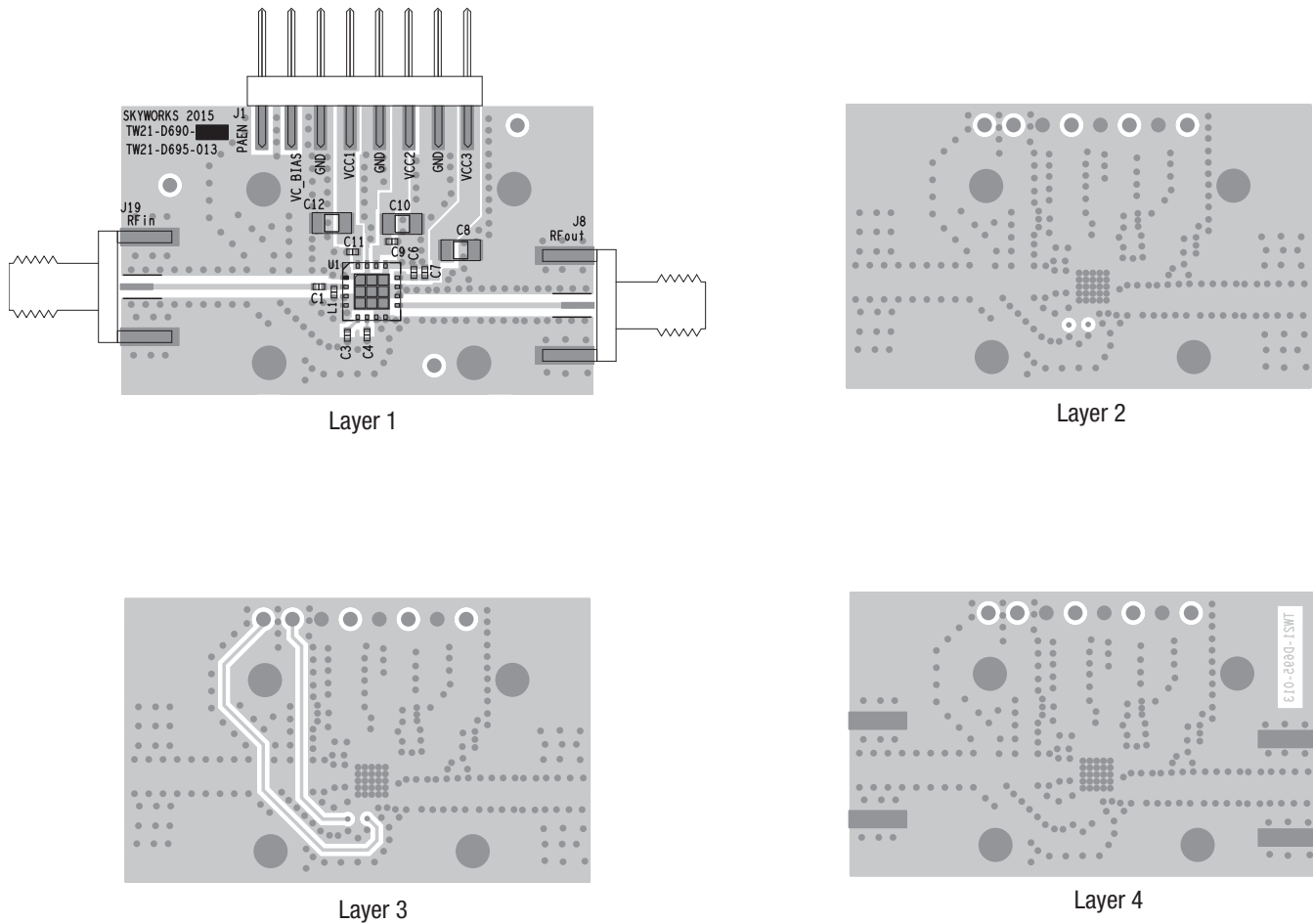

Figure 29. Evaluation Board Layer Details

50 Ohm	Cross Section	Name	Thickness (mm)	Materials
W = 0.500 mm 		TMask	0.010	Solder Resist
		L1	0.035	Cu, 1 oz.
		Dielectric	: 0.250	R04350
		L2	0.035	Cu, 1 oz.
		Dielectric	: 0.350	FR4
		L3	0.035	Cu, 1 oz.
		Dielectric	: 0.250	FR4
		L4	0.035	Cu, 1 oz.
		BMask	0.010	Solder Resist

203477-030

Figure 30. Layer Detail Physical Characteristics

Application Circuit Notes

Center Ground. It is extremely important to sufficiently ground the bottom ground pad of the device for both thermal and stability reasons. Multiple small vias are acceptable and work well under the device if solder migration is an issue.

GND (pins 1, 3, 4, 7, 8, 10, 11, 13, and 15). Attach all ground pins to the RF ground plane with the largest diameter and lowest inductance via that the layout allows. Multiple small vias are acceptable and will work well under the device if solder migration is an issue.

VCBIAS (pin 5). The bias supply voltage for each stage, nominally set to +5 V.

RFOUT (pin 9). Amplifier RF output pin ($Z_0 = 50 \Omega$). The module includes an onboard internal DC blocking capacitor. All impedance matching is provided internal to the module.

VCC1, VCC2, and VCC3 (pins 16, 15, and 12, respectively). Supply voltage for each stage collector bias is nominally set to 5 V. The evaluation board has inductors L1 and L2. These are place holders, and should be populated with 0Ω resistors. Bypass and decoupling capacitors C6 through C12 should be placed in the approximate location shown on the evaluation board assembly drawing, although exact placement is not critical.

RFIN (pin 2). Amplifier RF input pin ($Z_0 = 50 \Omega$). The module includes an internal DC blocking capacitor. All impedance matching is provided internal to the module.

Package Dimensions

The PCB layout footprint for the SKY66288-11 is shown in Figure 31. The typical part marking is shown in Figure 32. Package dimensions are shown in Figure 33, and tape and reel dimensions are provided in Figure 34.

Package and Handling Information

Since the device package is sensitive to moisture absorption, it is baked and vacuum packed before shipping. Instructions on the shipping container label regarding exposure to moisture after the container seal is broken must be followed. Otherwise, problems related to moisture absorption may occur when the part is subjected to high temperature during solder assembly.

The SKY66288-11 is rated to Moisture Sensitivity Level 3 (MSL3) at 250 °C. It can be used for lead or lead-free soldering. For additional information, refer to Skyworks Application Note, *PCB Design and SMT Assembly/Rework Guidelines for MCM-L Packages*, document number 101752.

Care must be taken when attaching this product, whether it is done manually or in a production solder reflow environment. Production quantities of this product are shipped in a standard tape and reel format.

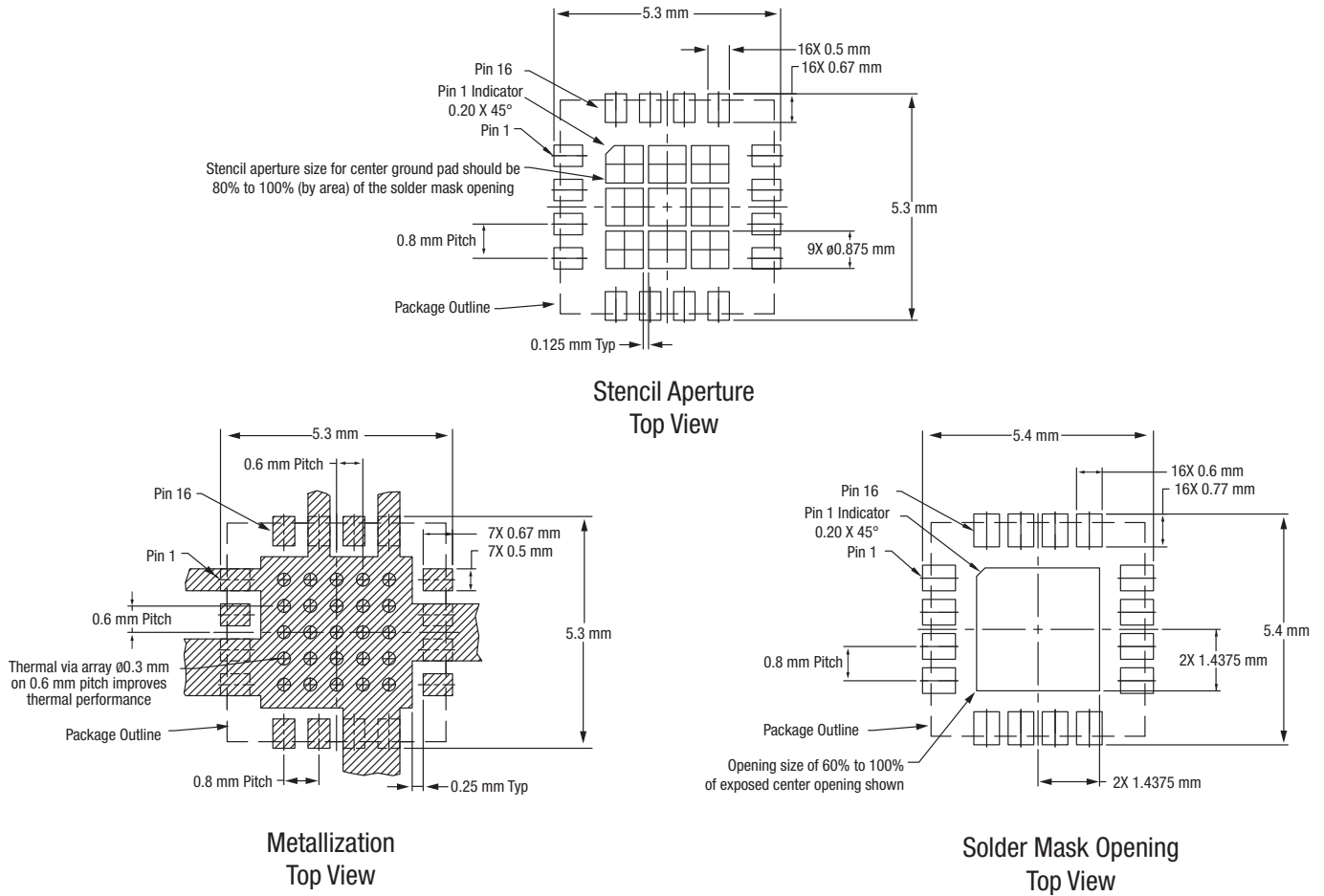

Notes:

1. Thermal vias should be resin filled and capped in accordance with IPC-4761 type VII vias.
2. Recommended Cu thickness is 30 to 35 μm .

203477-031

Figure 31. SKY66288-11 PCB Layout Footprint

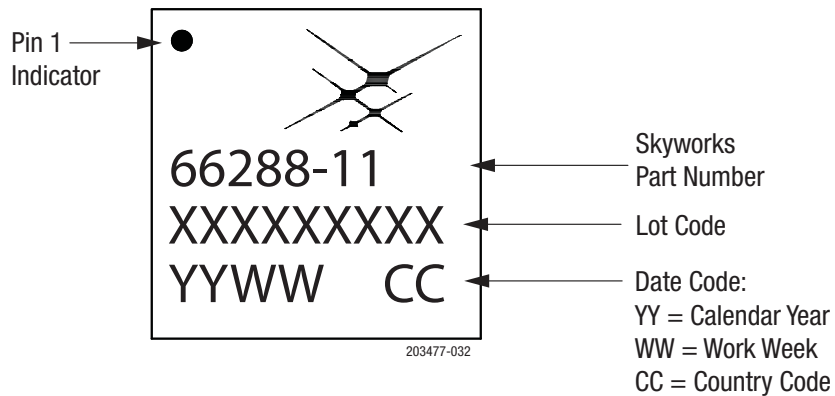

DATA SHEET • SKY66288-11: 5150 TO 5925 MHz HIGH-EFFICIENCY 4 W POWER AMPLIFIER

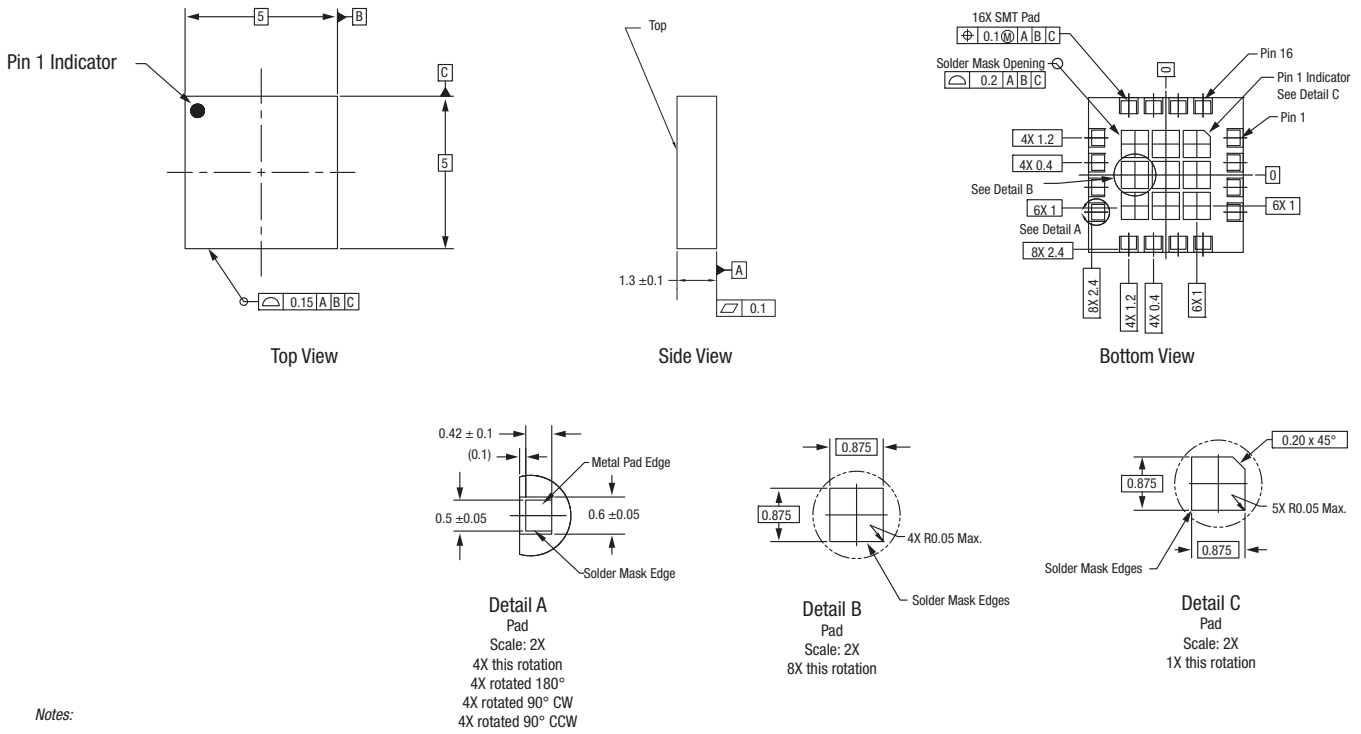

Notes:

1. Dimensions are in millimeters (unless otherwise specified).
2. Dimensions and tolerances are in accordance with ASME Y14.5M-1994.

203477-033

Figure 33. SKY66288-11 Package Dimensions

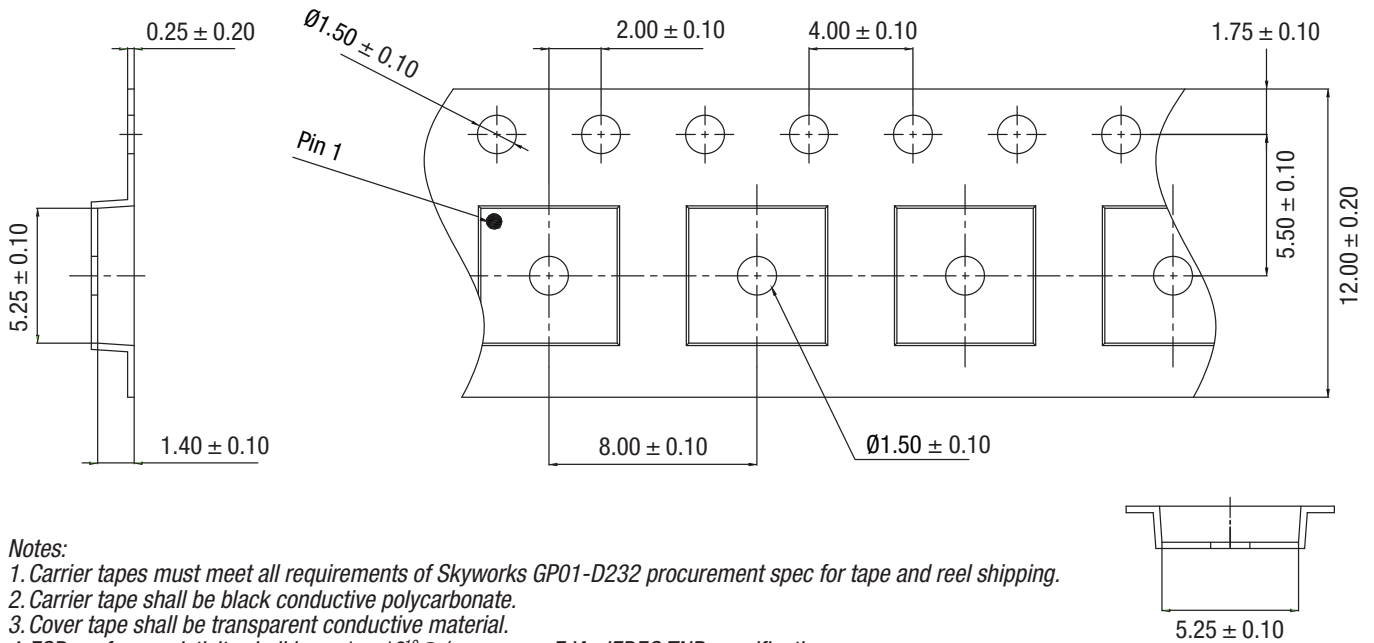

203477-034

Figure 34. SKY66288-11 Tape and Reel Dimensions

Ordering Information

Model Name	Manufacturing Part Number	Evaluation Board Part Number
SKY66288-11: 5150 to 5925 MHz High-Efficiency 4 W Power Amplifier	SKY66288-11	SKY66288-11-EVB

Copyright © 2015-2017 Skyworks Solutions, Inc. All Rights Reserved.

Information in this document is provided in connection with Skyworks Solutions, Inc. (“Skyworks”) products or services. These materials, including the information contained herein, are provided by Skyworks as a service to its customers and may be used for informational purposes only by the customer. Skyworks assumes no responsibility for errors or omissions in these materials or the information contained herein. Skyworks may change its documentation, products, services, specifications or product descriptions at any time, without notice. Skyworks makes no commitment to update the materials or information and shall have no responsibility whatsoever for conflicts, incompatibilities, or other difficulties arising from any future changes.

No license, whether express, implied, by estoppel or otherwise, is granted to any intellectual property rights by this document. Skyworks assumes no liability for any materials, products or information provided hereunder, including the sale, distribution, reproduction or use of Skyworks products, information or materials, except as may be provided in Skyworks Terms and Conditions of Sale.

THE MATERIALS, PRODUCTS AND INFORMATION ARE PROVIDED “AS IS” WITHOUT WARRANTY OF ANY KIND, WHETHER EXPRESS, IMPLIED, STATUTORY, OR OTHERWISE, INCLUDING FITNESS FOR A PARTICULAR PURPOSE OR USE, MERCHANTABILITY, PERFORMANCE, QUALITY OR NON-INFRINGEMENT OF ANY INTELLECTUAL PROPERTY RIGHT; ALL SUCH WARRANTIES ARE HEREBY EXPRESSLY DISCLAIMED. SKYWORKS DOES NOT WARRANT THE ACCURACY OR COMPLETENESS OF THE INFORMATION, TEXT, GRAPHICS OR OTHER ITEMS CONTAINED WITHIN THESE MATERIALS. SKYWORKS SHALL NOT BE LIABLE FOR ANY DAMAGES, INCLUDING BUT NOT LIMITED TO ANY SPECIAL, INDIRECT, INCIDENTAL, STATUTORY, OR CONSEQUENTIAL DAMAGES, INCLUDING WITHOUT LIMITATION, LOST REVENUES OR LOST PROFITS THAT MAY RESULT FROM THE USE OF THE MATERIALS OR INFORMATION, WHETHER OR NOT THE RECIPIENT OF MATERIALS HAS BEEN ADVISED OF THE POSSIBILITY OF SUCH DAMAGE.

Skyworks products are not intended for use in medical, lifesaving or life-sustaining applications, or other equipment in which the failure of the Skyworks products could lead to personal injury, death, physical or environmental damage. Skyworks customers using or selling Skyworks products for use in such applications do so at their own risk and agree to fully indemnify Skyworks for any damages resulting from such improper use or sale.

Customers are responsible for their products and applications using Skyworks products, which may deviate from published specifications as a result of design defects, errors, or operation of products outside of published parameters or design specifications. Customers should include design and operating safeguards to minimize these and other risks. Skyworks assumes no liability for applications assistance, customer product design, or damage to any equipment resulting from the use of Skyworks products outside of stated published specifications or parameters.

Skyworks and the Skyworks symbol are trademarks or registered trademarks of Skyworks Solutions, Inc., in the United States and other countries. Third-party brands and names are for identification purposes only, and are the property of their respective owners. Additional information, including relevant terms and conditions, posted at www.skyworksinc.com, are incorporated by reference.