

# SKY73020: 700 – 1000 MHz High Gain and Linearity Diversity Downconversion Mixer for 2G/3G Base Station Transceiver Applications

## Applications

- 2G/3G base station transceivers:
  - GSM/EDGE, CDMA, UMTS/WCDMA, iDEN
- Land mobile radio
- ISM band transceivers
- High performance radio links
- RF identification

## Features

- Operating frequency range: 700 to 1000 MHz
- IF frequency range: 50 to 250 MHz
- Conversion gain: 7.0 dB
- Input IP3: 27.0 dBm
- Output IP3: 34.0 dBm
- Noise figure: 10.2 dB
- Integrated LO drivers
- Integrated low-loss RF baluns
- High linearity IF amplifiers
- On-chip SPDT LO switch (greater than 65 dB LO-to-LO isolation)
- Small, MCM (36-pin, 6 x 6 mm) Pb-free package (MSL3, 260 °C per JEDEC J-STD-020)

**NEW** Skyworks offers lead (Pb)-free RoHS (Restriction of Hazardous Substances) compliant packaging.



## Description

The SKY73020 is a fully integrated diversity mixer that includes Local Oscillator (LO) drivers, an LO switch, high linearity mixers, and large dynamic range Intermediate Frequency (IF) amplifiers. Low-loss RF baluns have also been included to reduce design complications and lower system cost.

The SKY73020 features an input IP3 of 27.0 dBm and a Noise Figure (NF) of 10.2 dB, making the device an ideal solution for high dynamic range systems such as 2G/3G base station receivers. The LO switch provides more than 65 dB of isolation between LO inputs and supports the switching time required for GSM/EDGE base stations.

The SKY73020 is manufactured using a robust silicon BiCMOS process and has been designed for optimum long-term reliability. The SKY73020 diversity downconversion mixer is provided in a compact, 36-pin 6 x 6 mm Multi-Chip Module (MCM). A functional block diagram is shown in Figure 1. The pin configuration and package are shown in Figure 2. Signal pin assignments and functional pin descriptions are provided in Table 1.

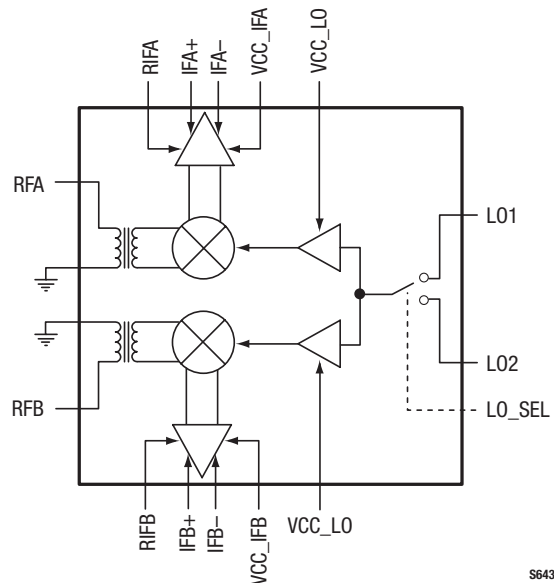

S643

**Figure 1. SKY73020 Block Diagram**

PRELIMINARY DATA SHEET • SKY73020 DOWNCONVERSION MIXER

www.DataSheet4U.com

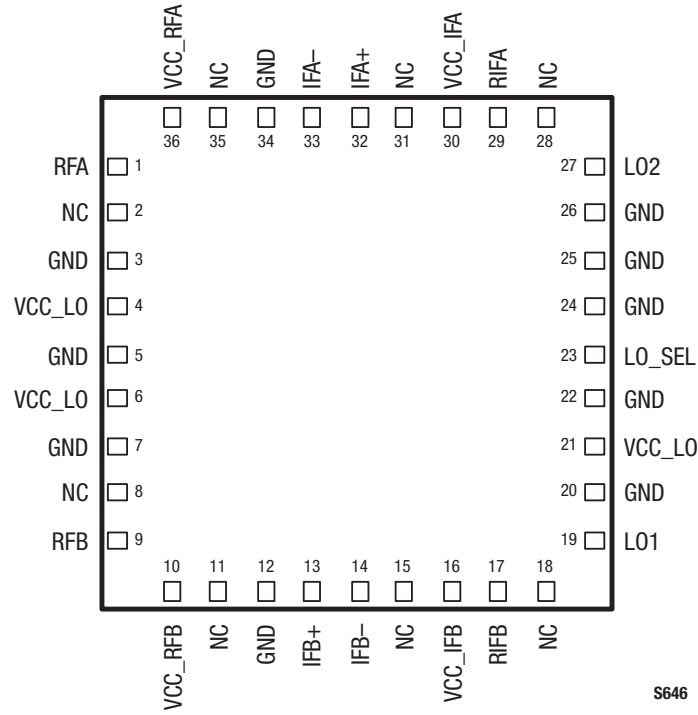

Figure 2. SKY73020 Pinout – 36-Pin MCM

Table 1. SKY73020 Signal Descriptions

Pin #	Name	Description	Pin #	Name	Description
1	RFA	Channel A RF input	19	LO1	Local oscillator 1 input
2	NC	No connect	20	GND	Ground
3	GND	Ground	21	VCC_LO	DC supply, +5 V
4	VCC_LO	DC supply, +5 V	22	GND	Ground
5	GND	Ground	23	LO_SEL	Local oscillator select switch control
6	VCC_LO	DC supply, +5 V	24	GND	Ground
7	GND	Ground	25	GND	Ground
8	NC	No connect	26	GND	Ground
9	RFB	Channel B RF input	27	LO2	Local oscillator 2 input
10	VCC_RFB	Channel B RF DC supply, +5 V	28	NC	No connect
11	NC	No connect	29	RIFA	Channel A IF bias adjust
12	GND	Ground	30	VCC_IFA	Channel A IF DC supply, +5 V
13	IFB+	Positive channel B IF output	31	NC	No connect
14	IFB-	Negative channel B IF output	32	IFA+	Positive channel A IF output
15	NC	No connect	33	IFA-	Negative channel A IF output
16	VCC_IFB	Channel B IF DC supply, +5 V	34	GND	Ground
17	RIFB	Channel B IF bias adjust	35	NC	No connect
18	NC	No connect	36	VCC_RFA	Channel A RF DC supply, +5 V

## Functional Description

The SKY73020 is a high gain diversity mixer, optimized for base station receiver applications. The device consists of two diversity channels (A and B), each consisting of a low-loss RF balun, high linearity passive mixer, and a low-noise IF amplifier.

Two LO amplifiers (independent of channels A and B) are also included that allow the SKY73020 to connect directly to the output of a Voltage Controlled Oscillator (VCO). This eliminates the extra gain stages needed by most discrete passive mixers. A Single-Pole, Double-Throw (SPDT) switch has been included to select between two different LO inputs for frequency hopping applications (i.e., GSM).

### RF Baluns and Passive Mixer

The RF baluns provide a single-ended input, which can easily be matched to 50 Ω using a simple external matching circuit. The RF baluns offer very low loss, and excellent amplitude and phase balance.

The high linearity SKY73020 is a passive, double balanced mixer that provides a very low conversion loss and an excellent 3<sup>rd</sup> Order Input Intercept Point (IIP3).

Additionally, the balanced nature of the mixer provides for high port-to-port isolation.

### LO Buffers and SPDT LO Switch

The LO buffers allow the input power of the SKY73020 to be in the range of ±3 dBm. The LO section is optimized for low-side LO injection. However, each of the two LOs can be driven over a wide frequency range with only slight degradation in performance.

A high isolation SPDT switch allows the SKY73020 to be used for frequency hopping applications. This switch provides greater than 65 dB of LO1 to LO2 isolation:

LO_SEL Input	LO Path Selected
High	LO1 (pin 19) enabled
Low	LO2 (pin 27) enabled

For applications that do not require frequency hopping, LO\_SEL is fixed to one state and the appropriate LO input is used. An internal pull-down resistor enables the LO2 input.

### IF Amplifier

The SKY73020 includes high dynamic range IF amplifiers that follow the passive mixers in the signal path. The outputs require a supply voltage connection using inductive chokes. These choke inductors should be high-Q and have the ability to handle 200 mA or greater.

A simple matching network allows the output ports to be matched to a balanced 200 Ω impedance. The IF amplifiers are optimized for IF frequencies between 50 and 250 MHz. The IF amplifiers can be operated outside of this range, but with a slight degradation in performance.

## Electrical and Mechanical Specifications

The absolute maximum ratings of the SKY73020 are provided in Table 2 and the recommended operating conditions in Table 3. Electrical characteristics for the SKY73020 are provided in Table 4.

Typical performance characteristics of the SKY73020 are illustrated in Figures 3 through 39.

**Table 2. SKY73020 Absolute Maximum Ratings**

Parameter	Symbol	Minimum	Maximum	Units
Supply voltage (VCC_LO, VCC_RFB, VCC_IFB, VCC_IFA, and VCC_RFA)	VCC		5.5	V
Supply current	I <sub>CC</sub>		420	mA
RF input power	P <sub>RF</sub>		20	dBm
LO input power	P <sub>LO</sub>		6	dBm
Operating case temperature	T <sub>C</sub>	-40	+85	°C
Storage case temperature	T <sub>STG</sub>	-40	+150	°C

**Note:** Exposure to maximum rating conditions for extended periods may reduce device reliability. There is no damage to device with only one parameter set at the limit and all other parameters set at or below their nominal value.

**Table 3. SKY73020 Recommended Operating Conditions**

Parameter	Symbol	Minimum	Typical	Maximum	Units
Supply voltage (VCC_LO, VCC_RFB, VCC_IFB, VCC_IFA, and VCC_RFA)	VCC	4.75	5.00	5.25	V
Supply current	I <sub>cc</sub>		370	420	mA
LO input power	P <sub>Lo</sub>	-3	0	+3	dBm
LO_SEL input: high	LO_SEL <sub>H</sub>	2.2			V
low	LO_SEL <sub>L</sub>			0.8	V
Operating case temperature	T <sub>c</sub>	-40		+85	°C
RF frequency range	F <sub>RF</sub>	700		1000	MHz
LO frequency range (Note 1)	F <sub>Lo</sub>	625		950	MHz
IF frequency range	F <sub>IF</sub>	50		250	MHz

**Note 1:** The SKY73020 has been optimized for low side LO injection. However, the LO can be used outside of the specified frequency range with degraded performance.

**Table 4. SKY73020 Electrical Specifications (1 of 2)**

**(VCC = +5 V, T<sub>c</sub> = +25 °C, LO Input Power = 0 dBm, RF Frequency = 900 MHz, IF Frequency = 70 MHz, LO Frequency = 830 MHz, Unless Otherwise Noted)**

Parameter	Symbol	Test Condition	Min	Typical	Max	Units
Conversion gain	G		5.0	7.0	8.0	dB
Noise Figure	NF			10.2	13.0	dB
Noise Figure with a blocker signal	NF <sub>BLK</sub>	Blocking signal input power = +8 dBm			23	dB
Third order input intercept point	IIP3	Tone spacing = 800 kHz, Input power = -10 dBm each tone		27.0		dBm
Third order output intercept point	OIP3	Tone spacing = 800 kHz, Input power = -10 dBm each tone	32.5	34.0		dBm
2RF – 2LO	2x2	P <sub>RF</sub> = -10 dBm			-63	dBc
3RF – 3LO	3x3	P <sub>RF</sub> = -10 dBm			-70	dBc
Input 1 dB compression point	IP1dB			16.5		dBm
Output 1 dB compression point	OP1dB		19.0	22.5		dBm
LO1-to-LO2 isolation				65		dB
Channel-to-channel isolation				46		dB
RF-to-IF isolation				75		dB
LO leakage: @ RF port				-45	-30	dBm
@ IF port				-80		dBm
LO_SEL input			-20	+150	+250	μA
LO switching time					1	μs

**Table 4. SKY73020 Electrical Specifications (2 of 2)**

(VCC = +5 V, Tc = +25 °C, LO Input Power = 0 dBm, RF Frequency = 900 MHz, IF Frequency = 70 MHz, LO Frequency = 830 MHz, Unless Otherwise Noted)

Parameter	Symbol	Test Condition	Min	Typical	Max	Units
RF port input return loss	Z <sub>IN_RF</sub>	With external matching components	-14			dB
LO port input return loss	Z <sub>IN_LO</sub>	With external matching components	-14			dB
IF port input return loss	Z <sub>OUT_IF</sub>	With external matching components	-14			dB

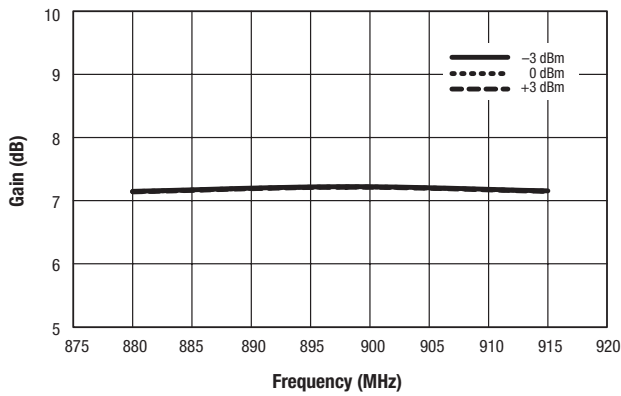

**Figure 3. Mixer A Gain vs Frequency and LO Power**

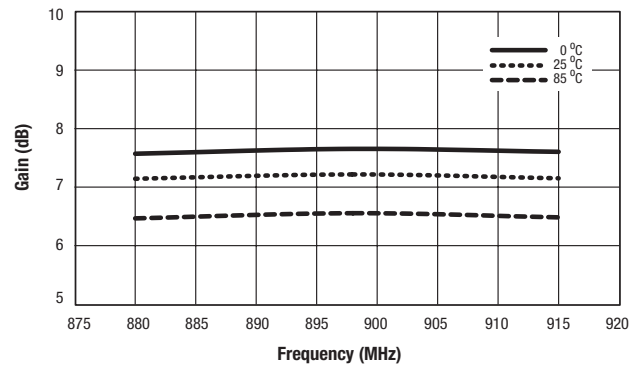

**Figure 4. Mixer A Gain vs Frequency and Temperature**

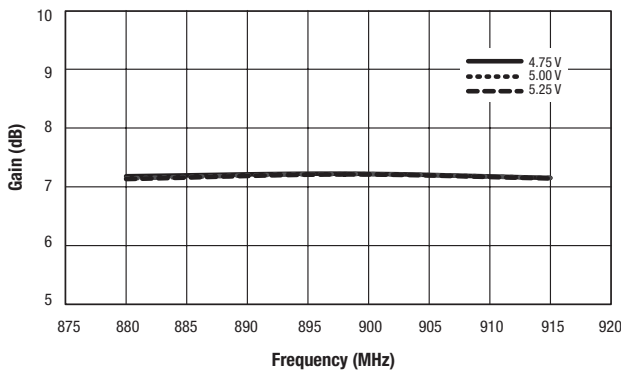

**Figure 5. Mixer A Gain vs Frequency and Supply Voltage**

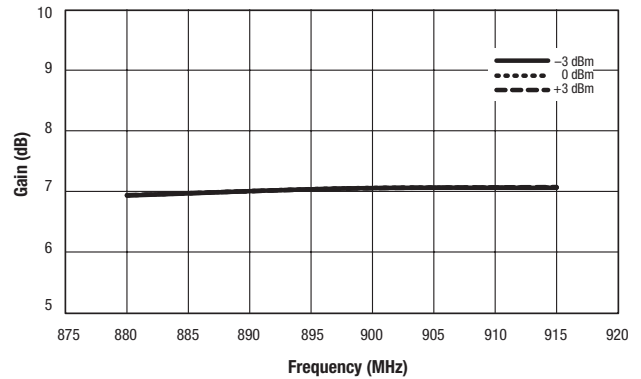

**Figure 6. Mixer B Gain vs Frequency and LO Power**

PRELIMINARY DATA SHEET • SKY73020 DOWNCONVERSION MIXER

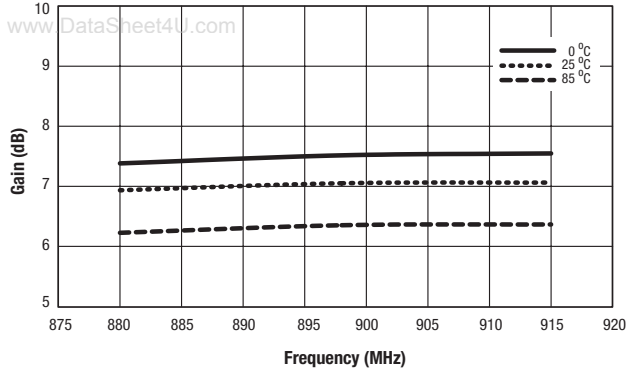

Figure 7. Mixer B Gain vs Frequency and Temperature

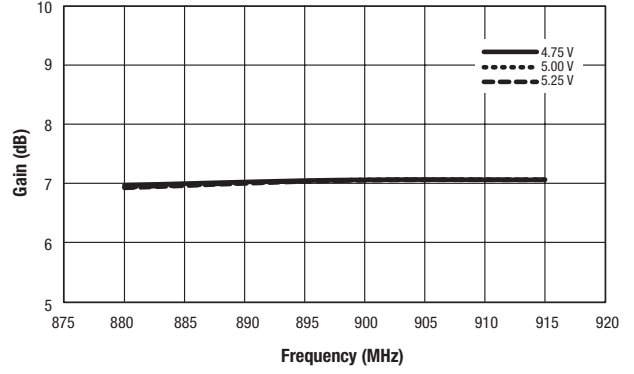

Figure 8. Mixer B Gain vs Frequency and Supply Voltage

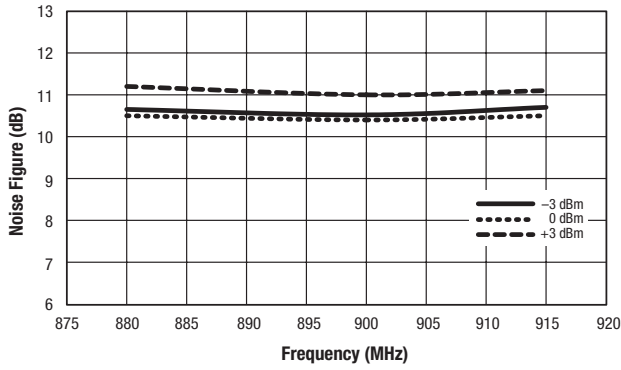

Figure 9. Mixer A Noise Figure vs Frequency and LO Power

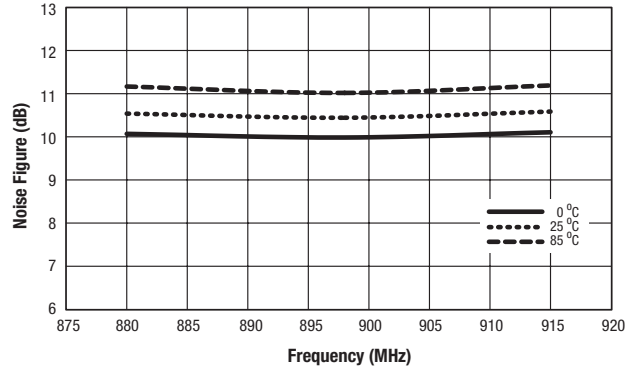

Figure 10. Mixer A Noise Figure vs Frequency and Temperature

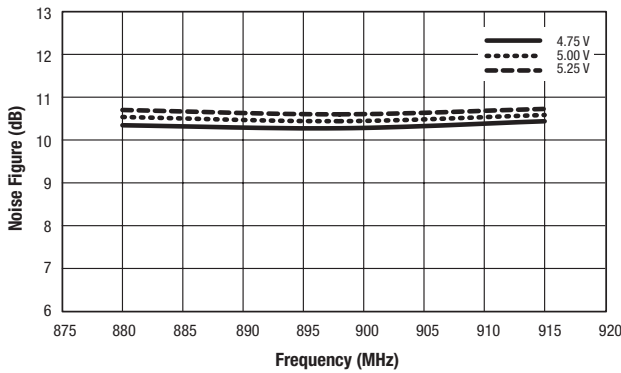

Figure 11. Mixer A Noise Figure vs Frequency and Supply Voltage

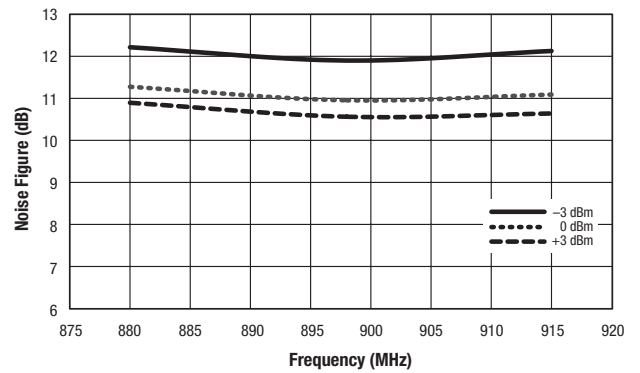

Figure 12. Mixer B Noise Figure vs Frequency and LO Power

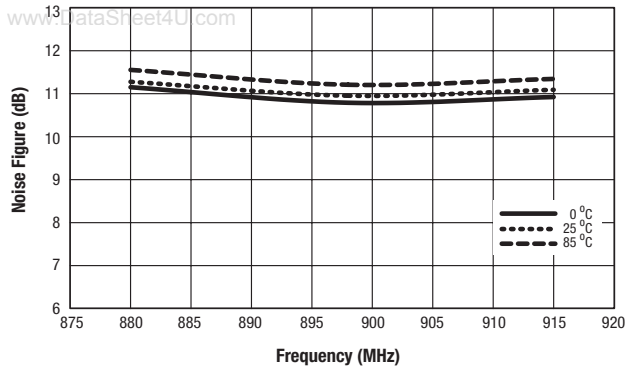

Figure 13. Mixer B Noise Figure vs Frequency and Temperature

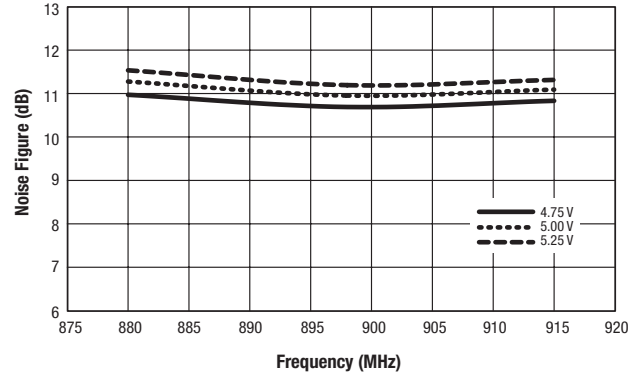

Figure 14. Mixer B Noise Figure vs Frequency and Supply Voltage

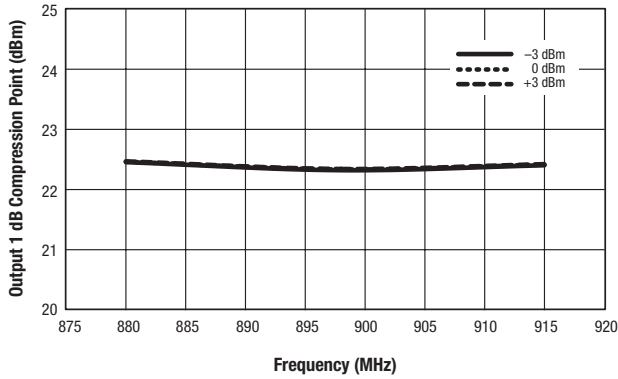

Figure 15. Mixer A OP1dB vs Frequency and LO Power

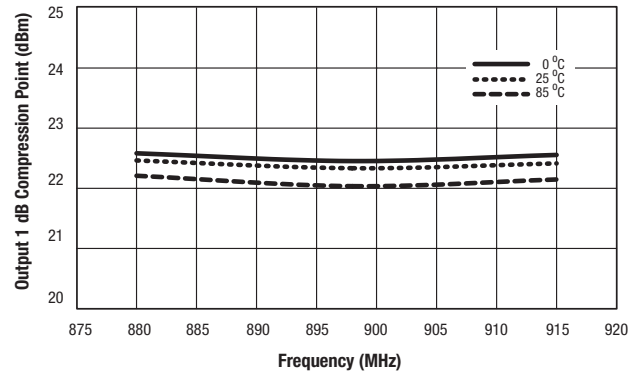

Figure 16. Mixer A OP1dB vs Frequency and Temperature

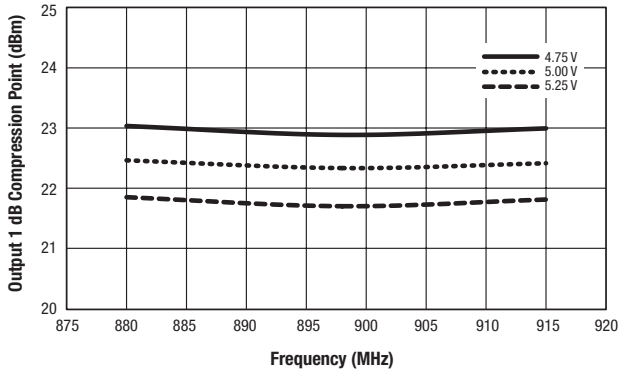

Figure 17. Mixer A OP1dB vs Frequency and Supply Voltage

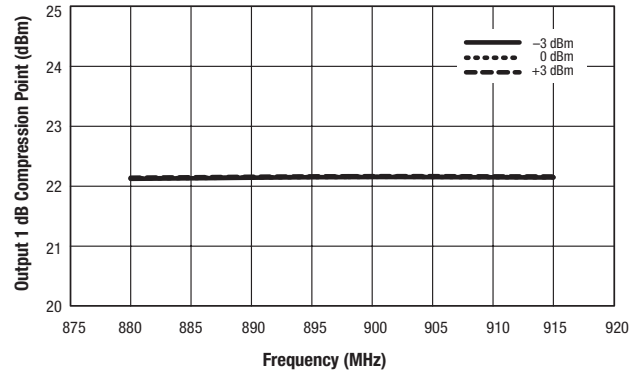

Figure 18. Mixer B OP1dB vs Frequency and LO Power

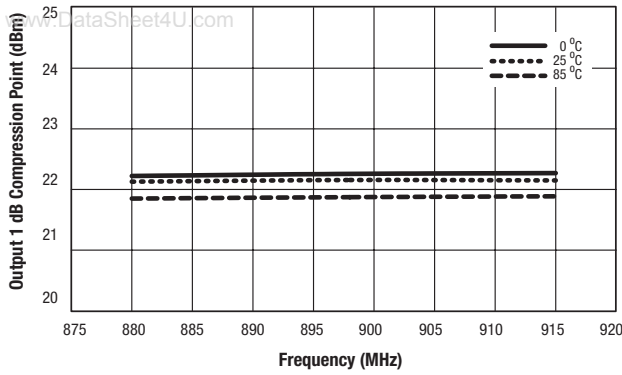

Figure 19. Mixer B OP1dB vs Frequency and Temperature

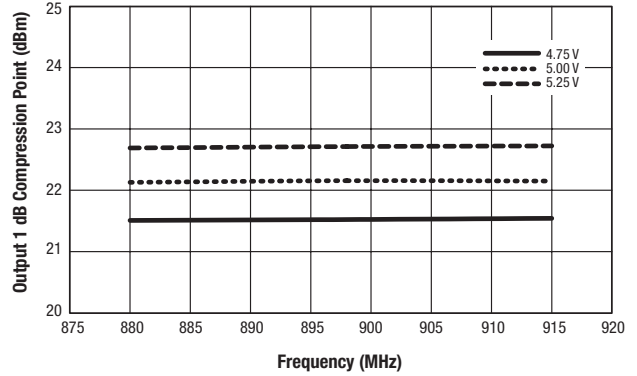

Figure 20. Mixer B OP1dB vs Frequency and Supply Voltage

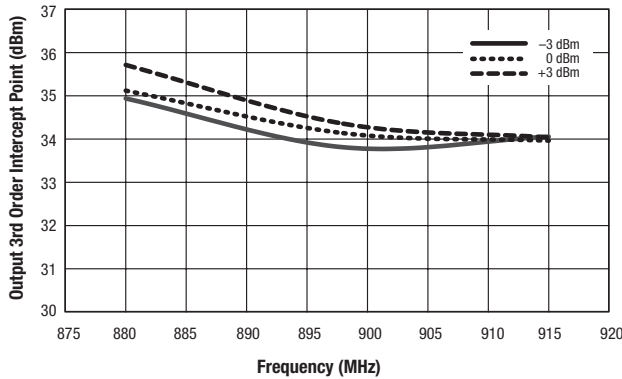

Figure 21. Mixer A OIP3 vs Frequency and LO Power

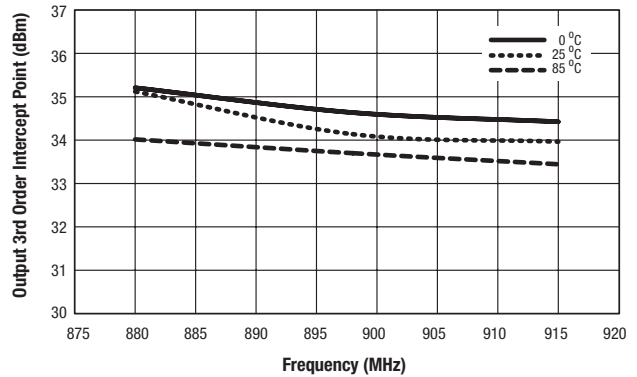

Figure 22. Mixer A OIP3 vs Frequency and Temperature

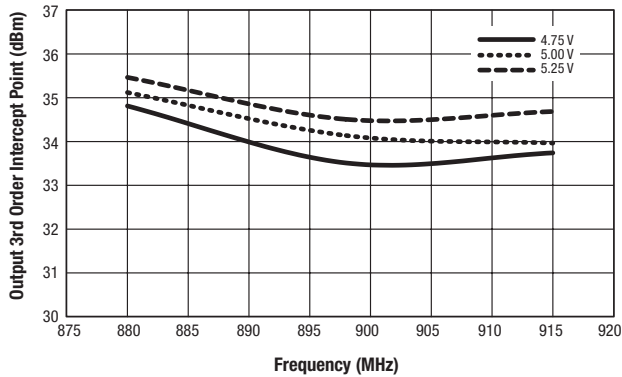

Figure 23. Mixer A OIP3 vs Frequency and Supply Voltage

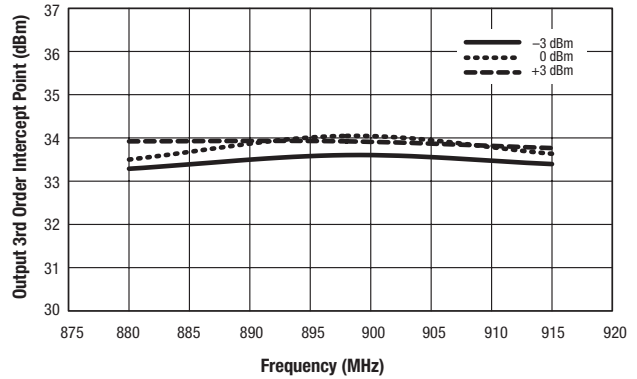

Figure 24. Mixer B OIP3 vs Frequency and LO Power



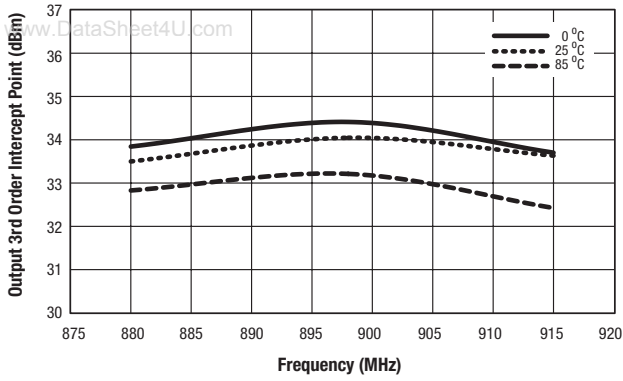

Figure 25. Mixer B OIP3 vs Frequency and Temperature

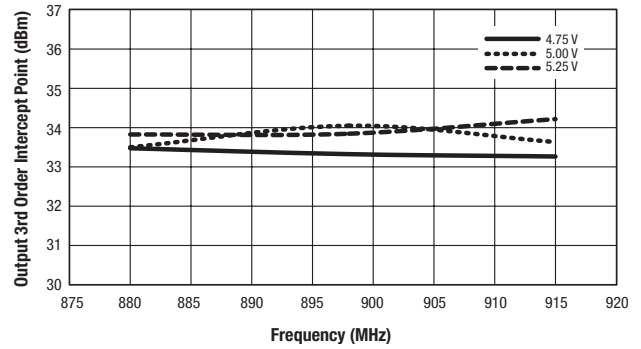

Figure 26. Mixer B OIP3 vs Frequency and Supply Voltage

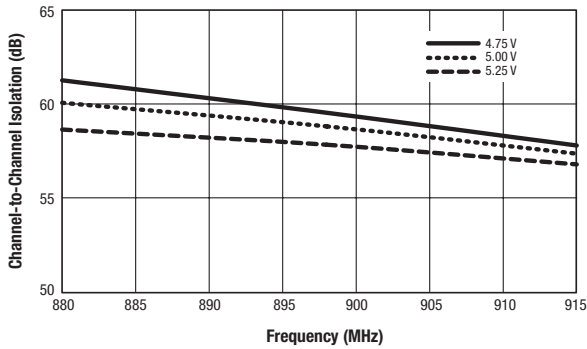

Figure 27. Channel A To Channel B Isolation vs Frequency and Supply Voltage

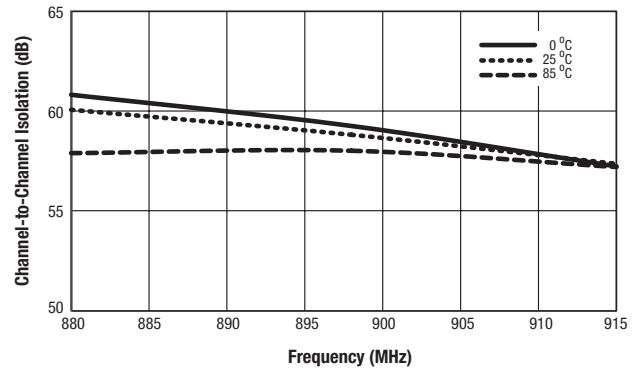

Figure 28. Channel A To Channel B Isolation vs Frequency and Temperature

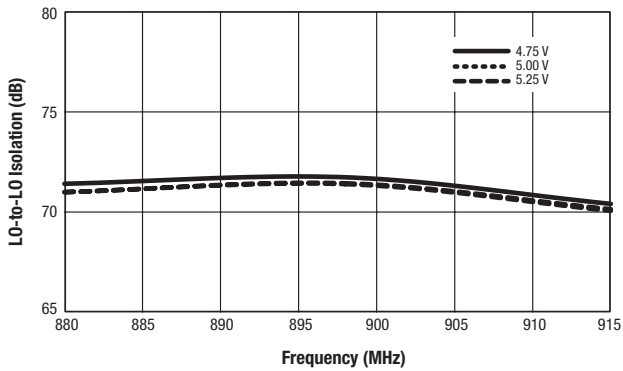

Figure 29. LO1-To-LO2 Isolation vs Frequency and Supply Voltage

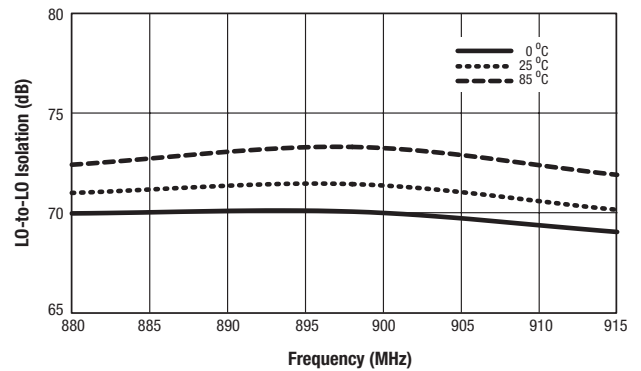

Figure 30. LO1-To-LO2 Isolation vs Frequency and Temperature

PRELIMINARY DATA SHEET • SKY73020 DOWNCONVERSION MIXER

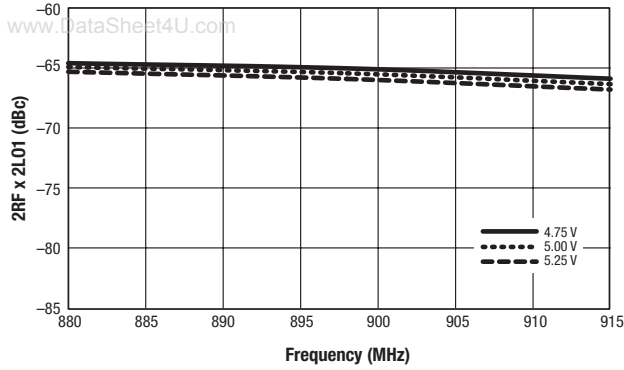

Figure 31. Channel A 2RF – 2LO vs Frequency and Supply Voltage

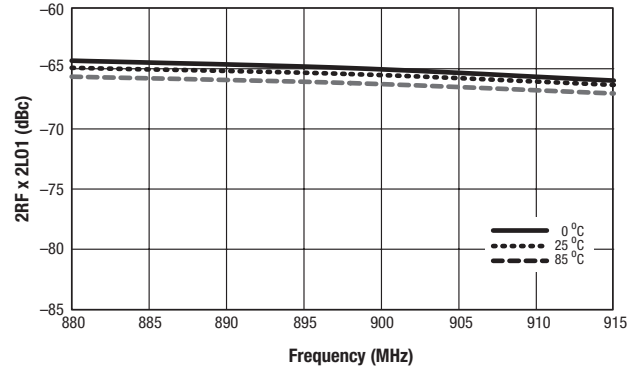

Figure 32. Channel A 2RF – 2LO vs Frequency and Temperature

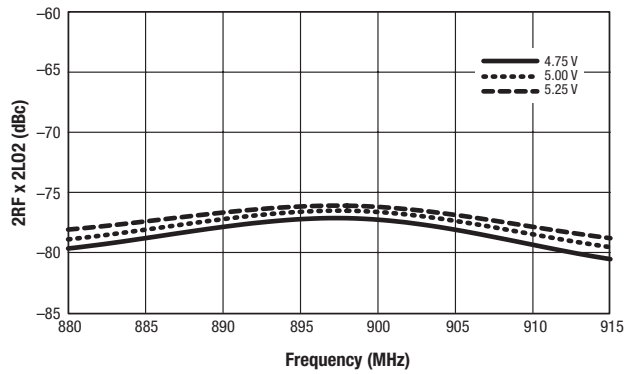

Figure 33. Channel B 2RF – 2LO vs Frequency and Supply Voltage

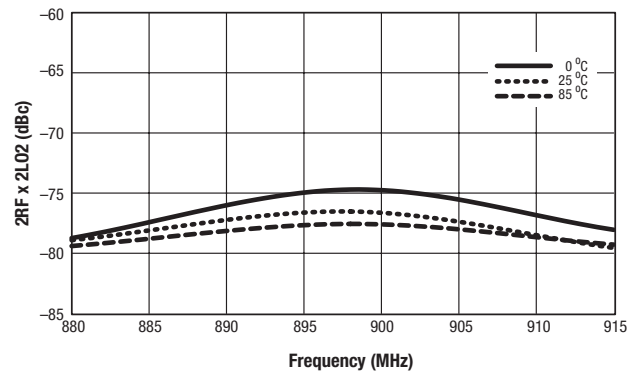

Figure 34. Channel B 2RF – 2LO vs Frequency and Temperature

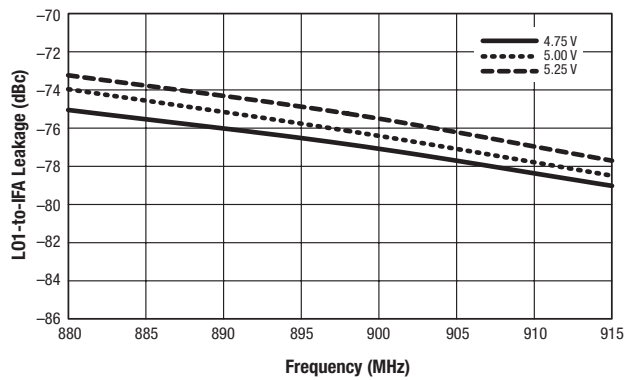

Figure 35. Channel A L01-to-IF Leakage vs Frequency and Supply Voltage

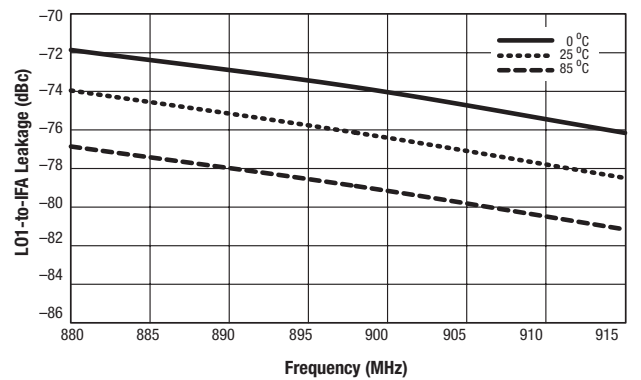
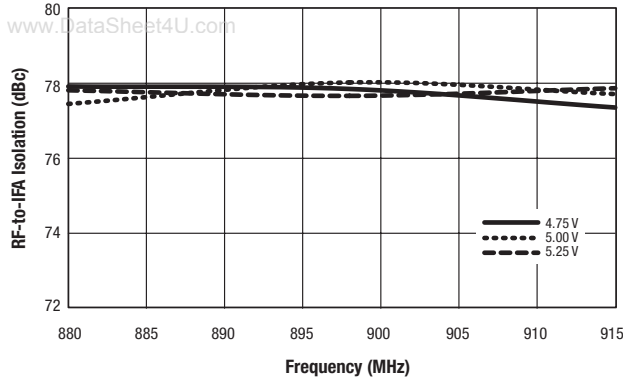
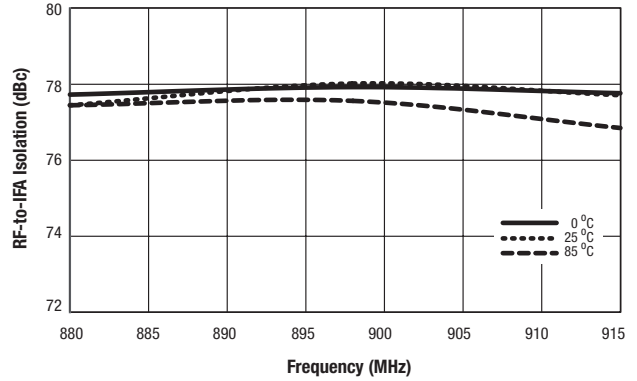

Figure 36. Channel A L01-to-IF Leakage vs Frequency and Temperature



**Figure 37. Channel A RF-to-IF Isolation vs Frequency and Supply Voltage**



**Figure 38. Channel A RF-to-IF Isolation vs Frequency and Temperature**

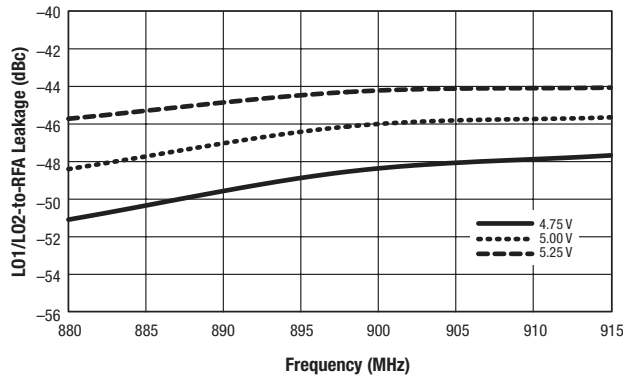

**Figure 39. Channel A L01-to-RF Leakage vs Frequency and Supply Voltage**

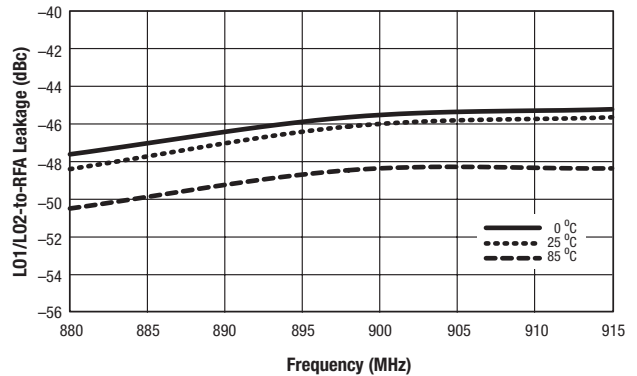

**Figure 40. Channel A L01-to-RF Leakage vs Frequency and Temperature**

**Evaluation Board Description**

The SKY73020 Evaluation Board is used to test the performance of the SKY73020 downconversion mixer. An assembly drawing for the Evaluation board is shown in Figure 41 and the layer detail is provided in Figure 42.

**Circuit Design Considerations**

The following design considerations are general in nature and must be followed regardless of final use or configuration:

1. Paths to ground should be made as short and as low impedance as possible.
2. The ground pad of the SKY73020 provides critical electrical and thermal functionality. This pad is the main thermal conduit for heat dissipation. Since the circuit board acts as the heat sink, it must shunt as much heat as possible from the device. Therefore, design the connection to the ground

pad to dissipate the maximum heat produced by the circuit board. For more information on soldering the SKY73020, refer to the Package and Handling Information section of this Data Sheet.

3. Skyworks recommends including external bypass capacitors on the VCC voltage inputs of the device.
4. Components L5, L6, L14, and L15 (see Figure 3) are high-Q, low-loss inductors. These inductors must be able to pass currents in excess of 200 mA DC.
5. Components R1 and R2 (see Figure 3) allow for external adjustment of the IF amplifier bias points. For operation as specified in Tables 3 and 4, these resistors are not required.

A schematic diagram for the SKY73020 Evaluation Board is shown in Figure 43.

www.DataSheet4U.com

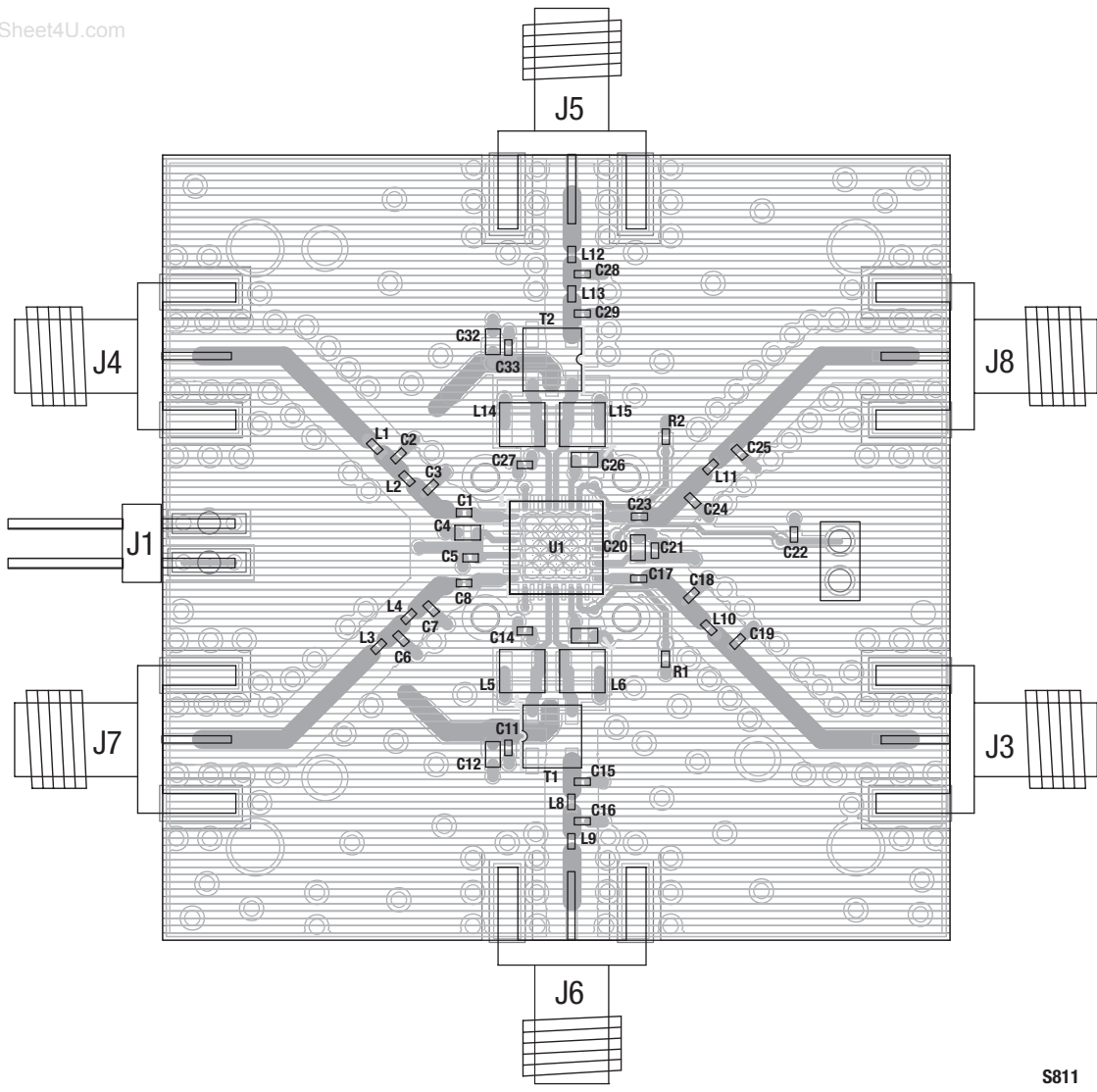

S811

Figure 41. SKY73020 Evaluation Board Assembly Diagram

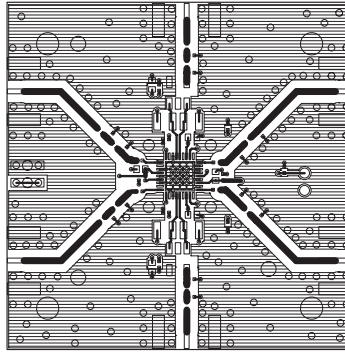

Layer 1: Top -- Metal

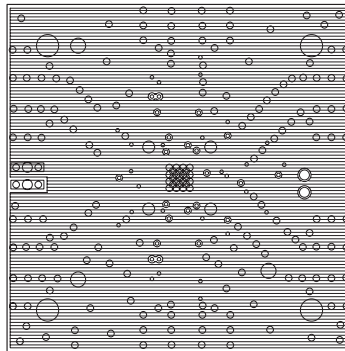

Layer 2: Ground

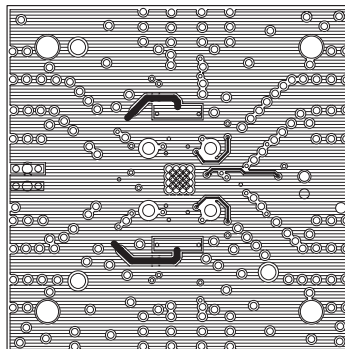

Layer 3: Power Plane

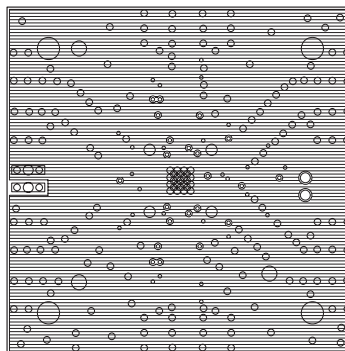

Layer 4: Solid Ground Plane

S903

**Figure 42. SKY73020 Evaluation Board Layer Detail**

www.DataSheet4U.com

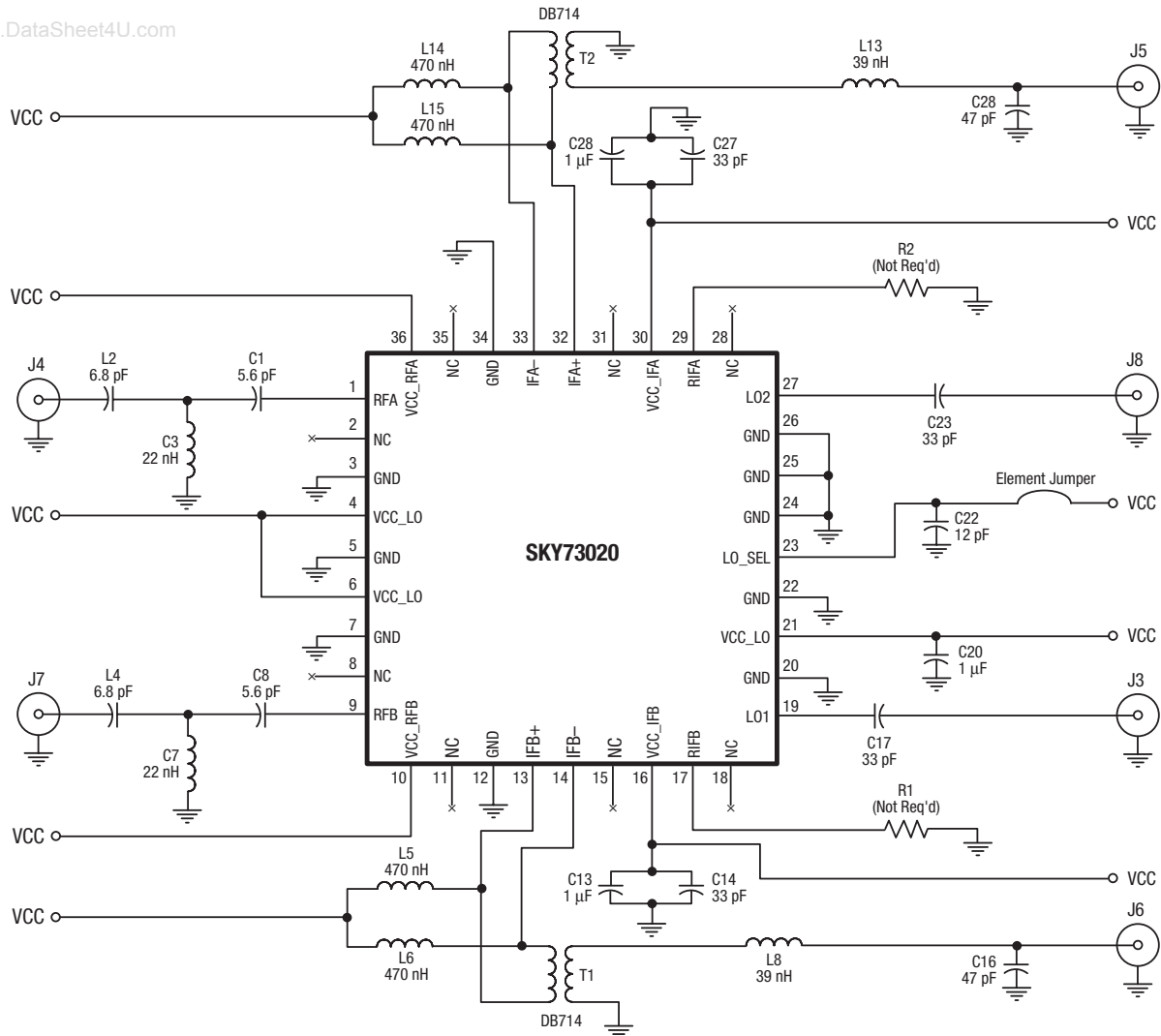

S685

Figure 43. SKY73020 Evaluation Board Schematic

**Package Dimensions**

Figure 44 shows the package dimensions for the 36-pin MCM and Figure 45 provides the tape and reel dimensions.

**Package and Handling Information**

Since the device package is sensitive to moisture absorption, it is baked and vacuum packed before shipping. Instructions on the shipping container label regarding exposure to moisture after the container seal is broken must be followed. Otherwise, problems related to moisture absorption may occur when the part is subjected to high temperature during solder assembly.

THE SKY73020 is rated to Moisture Sensitivity Level 3 (MSL3) at 260 °C. It can be used for lead or lead-free soldering. For additional information, refer to the Skyworks Application Note,

*PCB Design & SMT Assembly/Rework Guidelines for MCM-L Packages*, document number 101752.

Care must be taken when attaching this product, whether it is done manually or in a production solder reflow environment. Production quantities of this product are shipped in a standard tape and reel format. For packaging details, refer to the Skyworks Application Note, *Tape and Reel*, document number 101568.

**Electrostatic Discharge (ESD) Sensitivity**

The SKY73020 is a static-sensitive electronic device. Do not operate or store near strong electrostatic fields. Take proper ESD precautions.

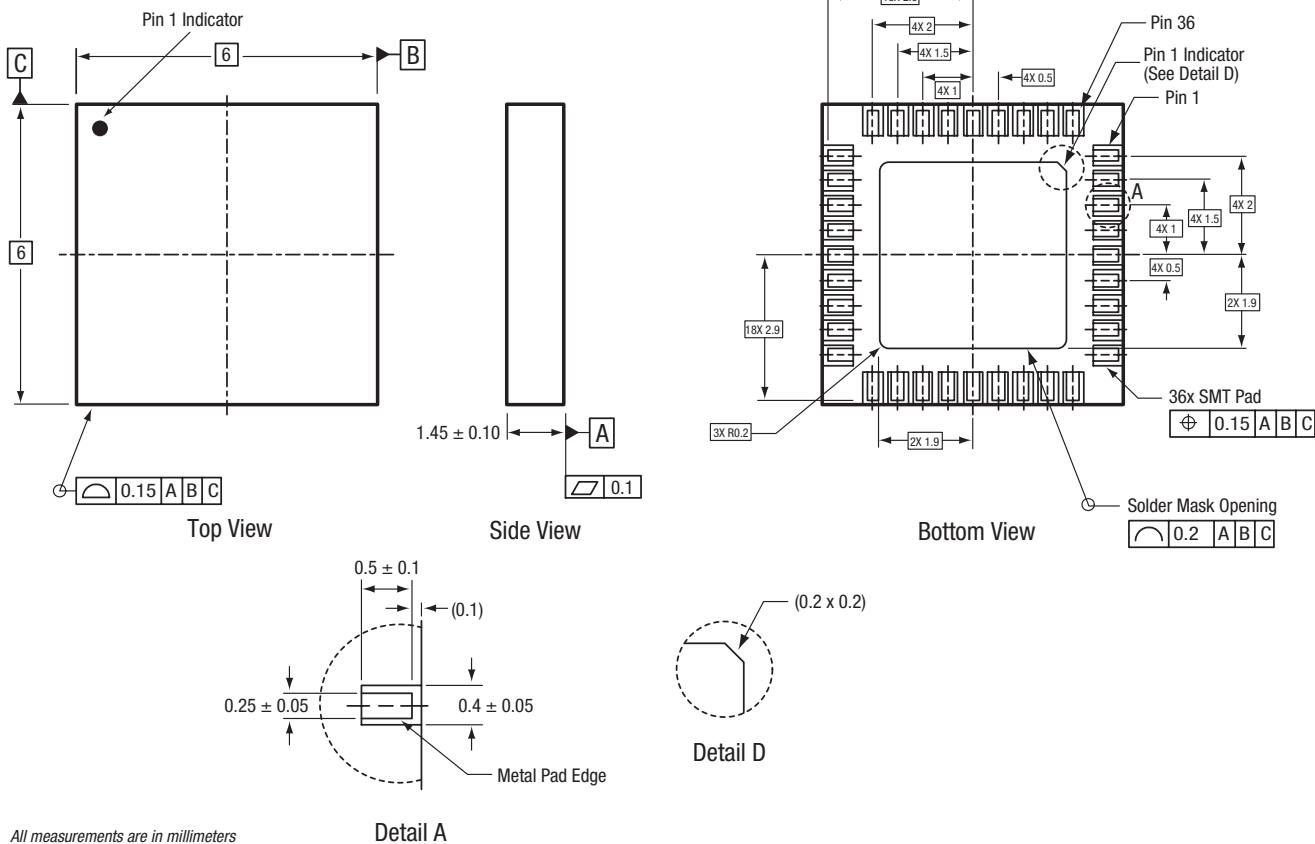

All measurements are in millimeters

Pads are solder mask defined on one edge and metal defined on three edges.

Dimensioning and tolerancing according to ASME Y14.5M-1994

S689

**Figure 44. SKY73020 36-Pin MCM Package Dimensions**

PRELIMINARY DATA SHEET • SKY73020 DOWNCONVERSION MIXER

www.DataSheet4U.com

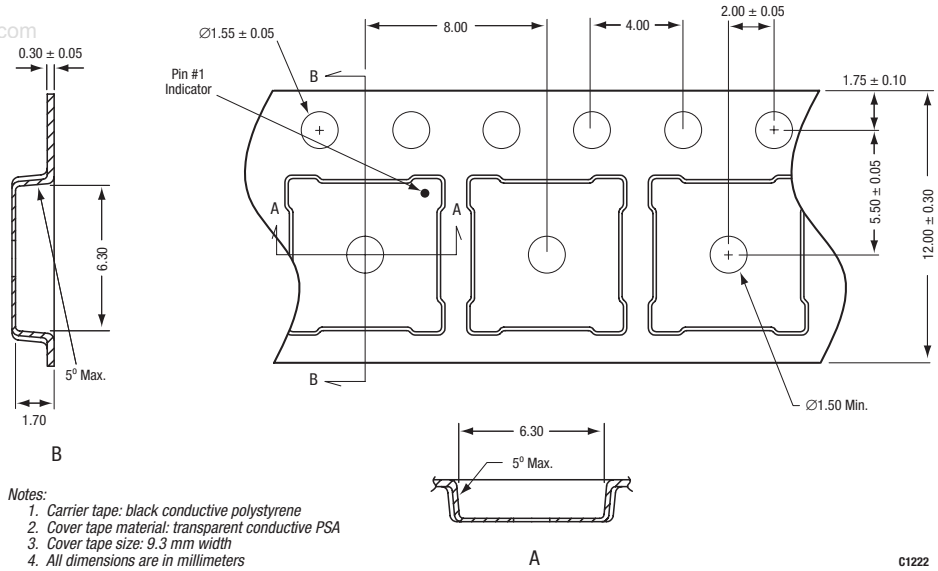

Figure 45. SKY73020 Tape and Reel Dimensions



**Ordering Information**

Model Name	Manufacturing Part Number	Evaluation Kit Part Number
SKY73020 Downconversion Mixer	SKY73020-11 (Pb-free package)	

Copyright © 2006 Skyworks Solutions, Inc. All Rights Reserved.

Information in this document is provided in connection with Skyworks Solutions, Inc. ("Skyworks") products or services. These materials, including the information contained herein, are provided by Skyworks as a service to its customers and may be used for informational purposes only by the customer. Skyworks assumes no responsibility for errors or omissions in these materials or the information contained herein. Skyworks may change its documentation, products, services, specifications or product descriptions at any time, without notice. Skyworks makes no commitment to update the materials or information and shall have no responsibility whatsoever for conflicts, incompatibilities, or other difficulties arising from any future changes.

No license, whether express, implied, by estoppel or otherwise, is granted to any intellectual property rights by this document. Skyworks assumes no liability for any materials, products or information provided hereunder, including the sale, distribution, reproduction or use of Skyworks products, information or materials, except as may be provided in Skyworks Terms and Conditions of Sale.

THE MATERIALS, PRODUCTS AND INFORMATION ARE PROVIDED "AS IS" WITHOUT WARRANTY OF ANY KIND, WHETHER EXPRESS, IMPLIED, STATUTORY, OR OTHERWISE, INCLUDING FITNESS FOR A PARTICULAR PURPOSE OR USE, MERCHANTABILITY, PERFORMANCE, QUALITY OR NON-INFRINGEMENT OF ANY INTELLECTUAL PROPERTY RIGHT; ALL SUCH WARRANTIES ARE HEREBY EXPRESSLY DISCLAIMED. SKYWORKS DOES NOT WARRANT THE ACCURACY OR COMPLETENESS OF THE INFORMATION, TEXT, GRAPHICS OR OTHER ITEMS CONTAINED WITHIN THESE MATERIALS. SKYWORKS SHALL NOT BE LIABLE FOR ANY DAMAGES, INCLUDING BUT NOT LIMITED TO ANY SPECIAL, INDIRECT, INCIDENTAL, STATUTORY, OR CONSEQUENTIAL DAMAGES, INCLUDING WITHOUT LIMITATION, LOST REVENUES OR LOST PROFITS THAT MAY RESULT FROM THE USE OF THE MATERIALS OR INFORMATION, WHETHER OR NOT THE RECIPIENT OF MATERIALS HAS BEEN ADVISED OF THE POSSIBILITY OF SUCH DAMAGE.

Skyworks products are not intended for use in medical, lifesaving or life-sustaining applications, or other equipment in which the failure of the Skyworks products could lead to personal injury, death, physical or environmental damage. Skyworks customers using or selling Skyworks products for use in such applications do so at their own risk and agree to fully indemnify Skyworks for any damages resulting from such improper use or sale.

Customers are responsible for their products and applications using Skyworks products, which may deviate from published specifications as a result of design defects, errors, or operation of products outside of published parameters or design specifications. Customers should include design and operating safeguards to minimize these and other risks. Skyworks assumes no liability for applications assistance, customer product design, or damage to any equipment resulting from the use of Skyworks products outside of stated published specifications or parameters.

Skyworks, the Skyworks symbol, and "Breakthrough Simplicity" are trademarks or registered trademarks of Skyworks Solutions, Inc., in the United States and other countries. Third-party brands and names are for identification purposes only, and are the property of their respective owners. Additional information, including relevant terms and conditions, posted at [www.skyworksinc.com](http://www.skyworksinc.com), are incorporated by reference.