

SKY73033-11: 1700 – 2200 MHz High Gain and Linearity Single Downconversion Mixer for 2G/3G Base Station Applications

Applications

- 2G/3G base station transceivers:
 - GSM/EDGE, CDMA, UMTS/WCDMA
- Land mobile radio
- Wireless Local Loop
- High performance radio links
- Private mobile radio

Features

- Operating frequency range: 1700 to 2200 MHz
- IF frequency range: 40 to 300 MHz
- Conversion gain: 8.9 dB
- Input IP3: 24.0 dBm
- Output IP3: 32.9 dBm
- Noise figure: 9.4 dB
- Integrated LO drivers
- Integrated low loss RF baluns
- High linearity IF amplifiers
- On-chip SPDT LO switch (greater than 40 dB LO-to-LO isolation)
- Small, MCM (20-pin, 5 x 5 mm) package (MSL3, 260 °C per JEDEC J-STD-020)

NEW

Skyworks offers lead (Pb)-free RoHS (Restriction of Hazardous Substances) compliant packaging.



Description

The SKY73033-11 is a fully integrated single mixer that includes Local Oscillator (LO) drivers, an LO switch, high linearity mixers, and large dynamic range Intermediate Frequency (IF) amplifiers. Low loss RF baluns have also been included to reduce design complications and lower system cost.

The SKY73033-11 features an input IP3 of 24.0 dBm and a Noise Figure (NF) of 9.4 dB, making the device an ideal solution for high dynamic range systems such as 2G/3G base station receivers. The LO switch provides more than 40 dB of isolation between LO inputs and supports the switching time required for GSM/EDGE base stations.

The SKY73033-11 is manufactured using a robust silicon BiCMOS process and has been designed for optimum long-term reliability. The SKY73033-11 single downconversion mixer is provided in a compact, 20-pin 5 x 5 mm Multi-Chip Module (MCM). A functional block diagram is shown in Figure 1. The pin configuration and package are shown in Figure 2. Signal pin assignments and functional pin descriptions are provided in Table 1.

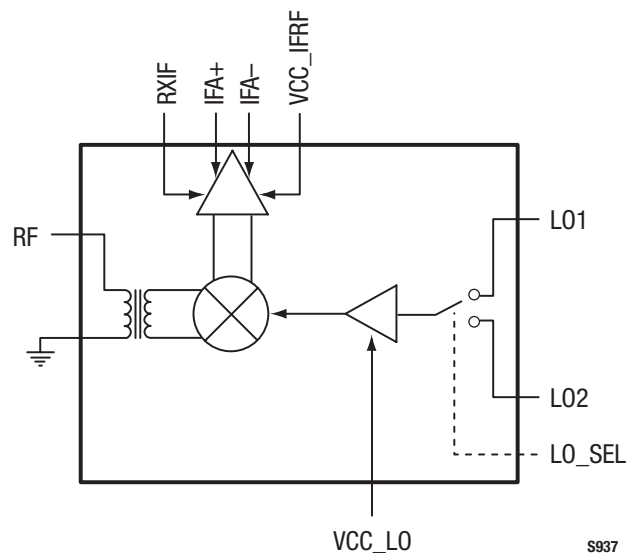
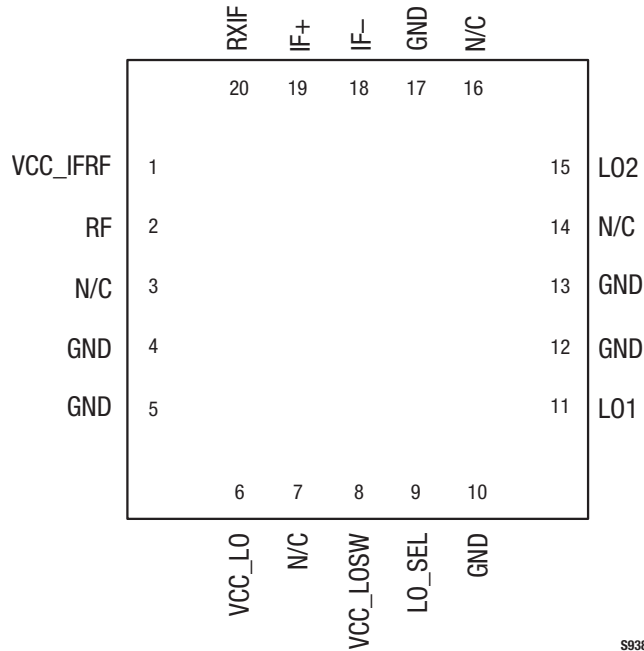

Figure 1. SKY73033-11 Block Diagram



S938

Figure 2. SKY73033-11 Pinout – 20-Pin MCM

Table 1. SKY73033-11 Signal Descriptions

Pin #	Name	Description	Pin #	Name	Description
1	VCC_IFRF	IF and RF DC supply, +5V	11	LO1	LO1 input
2	RF	RF input	12	GND	Ground
3	N/C	No connection	13	GND	Ground
4	GND	Ground	14	N/C	No connection
5	GND	Ground	15	LO2	LO2 input
6	VCC_LO	LO DC supply, +5V	16	N/C	No connection
7	N/C	No connection	17	GND	Ground
8	VCC_LOSW	LO switch DC supply, +5V	18	IF-	Negative IF output
9	LO_SEL	LO select switch control	19	IF+	Positive IF output
10	GND	Ground	20	RXIF	IF bias adjust

Functional Description

The SKY73033-11 is a high gain single mixer, optimized for base station receiver applications. The device consists of a low loss RF balun, high linearity passive mixer, and a low noise IF amplifier.

An LO amplifier is also included that allow the SKY73033-11 to connect directly to the output of a Voltage Controlled Oscillator (VCO). This eliminates the extra gain stages needed by most discrete passive mixers. A Single Pole, Double Throw (SPDT) switch has been included to select between two different LO inputs (LO1 and LO2) for frequency hopping applications such as GSM.

RF Baluns and Passive Mixer

The RF baluns provide a single ended input, which can easily be matched to 50 Ω using a simple external matching circuit. The RF baluns offer very low loss, and excellent amplitude and phase balance.

The high linearity SKY73033-11 is a passive, double balanced mixer that provides a very low conversion loss, and excellent 3rd Order Input Insertion Point (IIP3).

Additionally, the balanced nature of the mixer provides for high port-to-port isolation.

LO Buffers and SPDT LO Switch

The LO buffers allow the input power of the SKY73033-11 to be in the range of ±6 dBm. The LO section is optimized for low-side LO injection. However, each of the two LOs can be driven over a wide frequency range with only slight degradation in performance.

A high isolation SPDT switch allows the SKY73033-11 to be used for frequency hopping applications. This switch provides greater than 40 dB of LO1 to LO2 isolation:

LO_SEL Input	LO Path Selected
High	LO1 (pin 11) enabled
Low	LO2 (pin 15) enabled

For applications that do not require frequency hopping, LO_SEL is fixed to one state and the appropriate LO input is used. An internal pull-down resistor enables the LO2 input.

IF Amplifier

The SKY73033-11 includes high dynamic range IF amplifiers that follow the passive mixers in the signal path. The outputs require a supply voltage connection using inductive chokes. These choke inductors should be high-Q and have the ability to handle 200 mA or greater.

A simple matching network allows the output ports to be matched to a balanced 200 Ω impedance. The IF amplifiers are optimized for IF frequencies between 40 and 300 MHz. The IF amplifiers can be operated outside of this range, but with a slight degradation in performance.

Electrical and Mechanical Specifications

The absolute maximum ratings of the SKY73033-11 are provided in Table 2 and the recommended operating conditions in Table 3. Electrical characteristics for the SKY73033-11 are provided in Table 4.

Typical performance characteristics of the SKY73033-11 are illustrated in Figures 3 through 20.

Table 2. SKY73033-11 Absolute Maximum Ratings (Note 1)

Parameter	Symbol	Minimum	Maximum	Units
Supply voltage, +5 V	VCC	4.5	5.5	V
Supply current	I _{CC}		240	mA
RF input power	P _{RF}		+20.0	dBm
LO input power	P _{LO}		+20.0	dBm
Operating case temperature	T _C	-40	+85	°C
Junction temperature (Note 2)	T _J		+150	°C
Storage case temperature	T _{STG}	-40	+125	°C

Note 1: Exposure to maximum rating conditions for extended periods may reduce device reliability. There is no damage to device with only one parameter set at the limit and all other parameters set at or below their nominal value. Exceeding any of the limits listed here may result in permanent damage to the device.

Note 2: Nominal thermal resistance (junction to center ground pad) is 5.1 °C/W.

CAUTION: Although this device is designed to be as robust as possible, Electrostatic Discharge (ESD) can damage this device. This device must be protected at all times from ESD. Static charges may easily produce potentials of several kilovolts on the human body or equipment, which can discharge without detection. Industry-standard ESD precautions should be used at all times.

Table 3. SKY73033-11 Recommended Operating Conditions

Parameter	Symbol	Minimum	Typical	Maximum	Units
Supply voltage, +5 V	VCC	4.75	5.00	5.25	V
Supply current	I _{CC}		200		mA
LO input power	P _{LO}	-6	0	+6	dBm
LO select input: high low	LO_SELH LO_SEL	2.2		0.8	V V
Operating case temperature	T _C	-40		+85	°C
RF frequency range	F _{RF}	1700		2200	MHz
LO frequency range (Note 1)	F _{LO}	1460		2000	MHz
IF frequency range	F _{IF}	40		300	MHz

Note 1: The SKY73033-11 has been optimized for low side LO injection. However, the LO can be used outside of the specified frequency range with degraded performance.

Table 4. SKY73033-11 Electrical Specifications (Note 1) (1 of 2)

(Voltage Supply = +5 V, T_C = +25 °C, LO = 0 dBm, RF Frequency = 1748 MHz, IF Frequency = 201 MHz, LO Frequency = 1547 MHz, Unless Otherwise Noted)

Parameter	Symbol	Test Condition	Min	Typical	Max	Units
Conversion gain	G	F _{RF} = 1710 to 1980 MHz, VCC = 4.75 to 5.25 V, P _{LO} = -3 to +3 dBm	7.5	8.9		dB
Gain variation over temperature		T _C = -40 to +85 °C		±0.8		dB
Noise Figure	NF			9.4		dB
Noise Figure with a blocker signal	NF _{BLK}	Blocking signal input power = +8 dBm		23		dB
Third order input intercept point	IIP3	F _{RF} = 1748 and 1748.8 MHz, P _{RF} = -10 dBm/each tone, VCC = 4.75 to 5.25 V, P _{LO} = -3 to +3 dBm	22.5	24.0		dBm

Table 4. SKY73033-11 Electrical Specifications (Note 1) (2 of 2)**(Voltage Supply = +5 V, T_c = +25 °C, LO = 0 dBm, RF Frequency = 1748 MHz, IF Frequency = 201 MHz, LO Frequency = 1547 MHz, Unless Otherwise Noted)**

Parameter	Symbol	Test Condition	Min	Typical	Max	Units
Input IP3 variation over temperature		F _{RF} = 1748 and 1748.8 MHz, T _c = -40 to +85 °C		±0.2		dB
Third order output intercept point	OIP3	F _{RF} = 1748 and 1748.8 MHz, P _{RF} = -10 dBm/each tone, VCC = 4.75 to 5.25 V, P _{LO} = -3 to +3 dBm		32.9		dBm
2RF – 2LO	2x2	P _{RF} = -10 dBm		-71	-63	dBc
3RF – 3LO	3x3	P _{RF} = -10 dBm		-80	-70	dBc
Input 1 dB compression point	IP1dB	F _{RF} = 1710 to 1980 MHz, VCC = 4.75 to 5.25 V, P _{LO} = -3 to +3 dBm	11.5	13.5		dBm
Output 1 dB compression point	OP1dB			21.4		dBm
LO1-to-LO2 isolation				40		dB
RF to IF isolation			45	55		dB
LO leakage: @ RF port				-37	-28	dBm
@ IF port				-56	-33	dBm
LO_SEL input			-20	150	250	μA
LO switching time					1.0	μs
RF port input return loss	Z _{IN_RF}	With external matching components	14			dB
LO port input return loss	Z _{IN_LO}	With external matching components	14			dB
IF port input return loss	Z _{OUT_IF}	With external matching components	14			dB

Note 1: Performance is guaranteed only under the conditions listed in this Table and is not guaranteed over the full operating or storage temperature ranges. Exceeding any of the conditions listed here may result in permanent damage to the device. Operation at elevated temperatures may reduce reliability of the device.

Typical Performance Characteristics

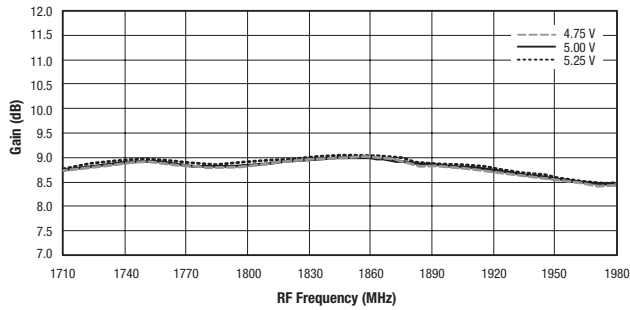

Figure 3. Mixer Gain vs Frequency and Supply Voltage

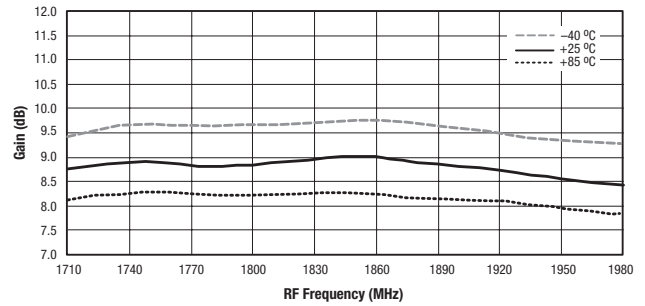

Figure 4. Mixer Gain vs Frequency and Temperature

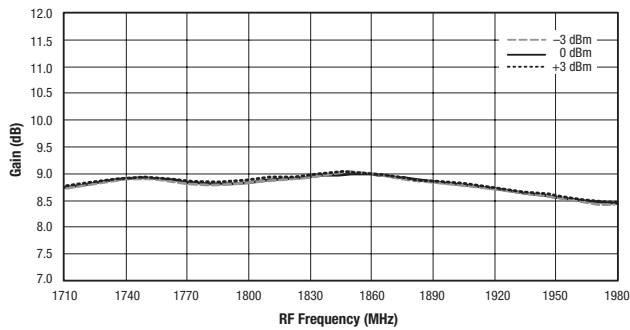

Figure 5. Mixer Gain vs Frequency and LO Power

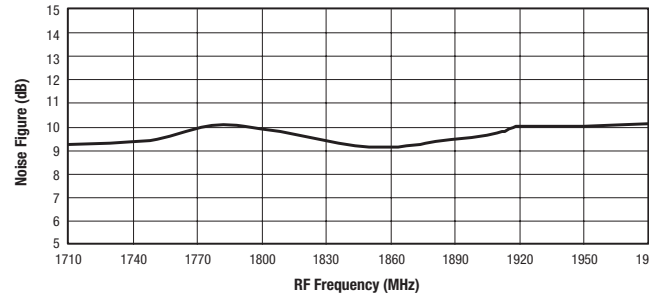

Figure 6. Mixer Noise Figure vs Frequency

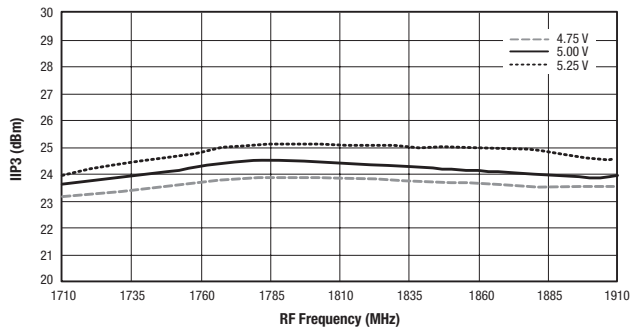

Figure 7. 1800 MHz and 1900 MHz Mixer IIP3 vs Frequency and Supply Voltage

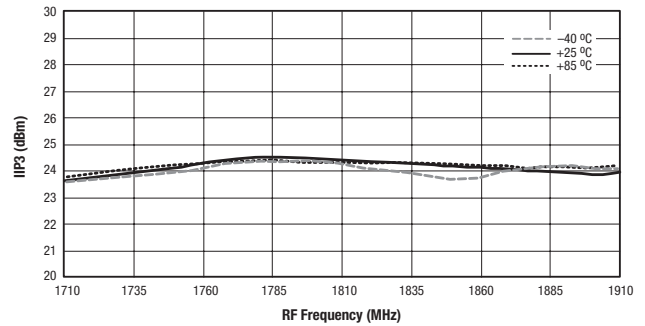

Figure 8. 1800 MHz and 1900 MHz Mixer IIP3 vs Frequency and Temperature

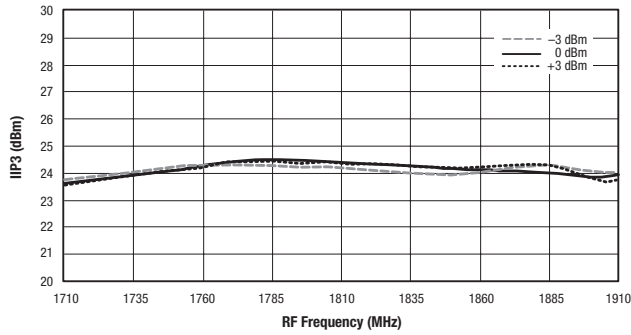

Figure 9. 1800 MHz and 1900 MHz Mixer IIP3 vs Frequency and LO Power

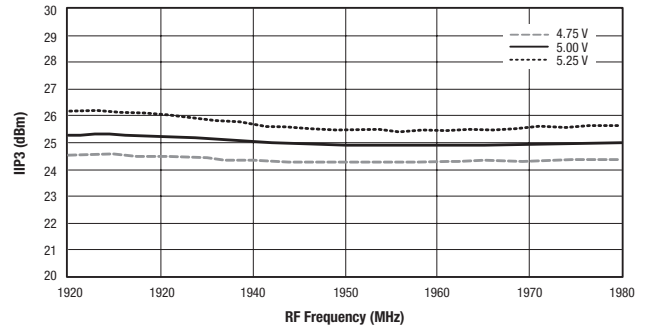

Figure 10. 2100 MHz Mixer IIP3 vs Frequency and Supply Voltage

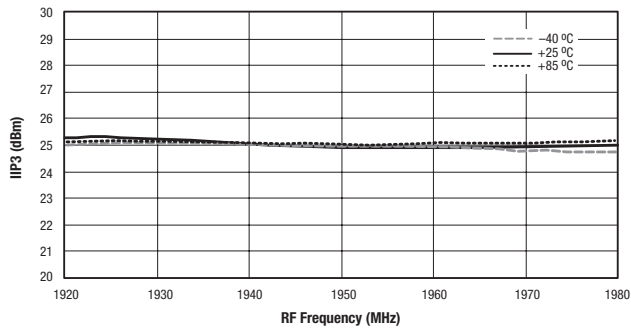

Figure 11. 2100 MHz Mixer IIP3 vs Frequency and Temperature

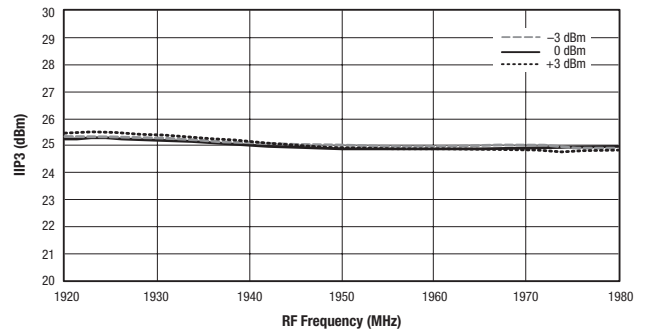

Figure 12. 2100 MHz Mixer IIP3 vs Frequency and LO Power

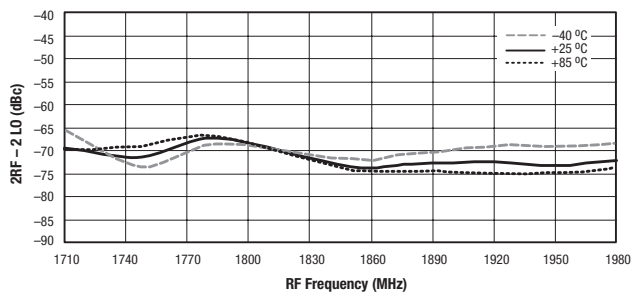

Figure 13. Mixer 2RF-2LO vs Frequency and Temperature

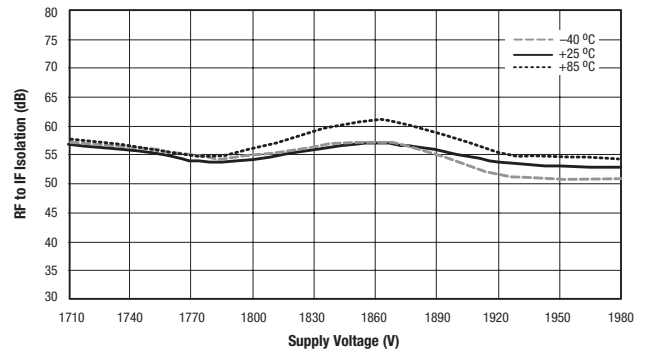

Figure 14. Mixer RF to IF Isolation vs Frequency and Temperature

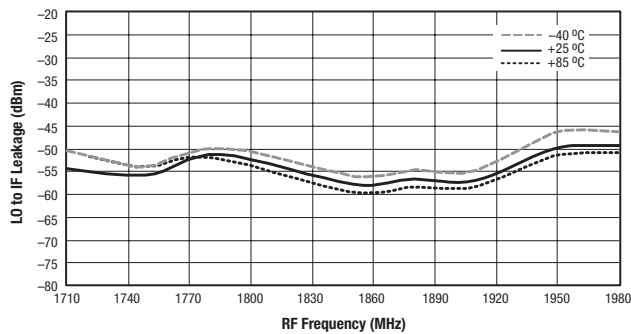

Figure 15. Mixer LO to IF Leakage vs Frequency and Temperature

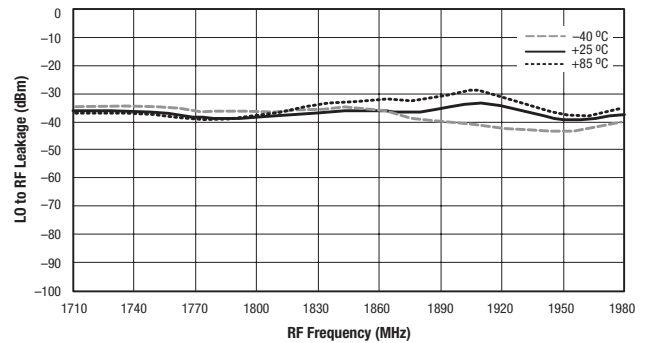

Figure 16. Mixer LO to RF Leakage vs Frequency and Temperature

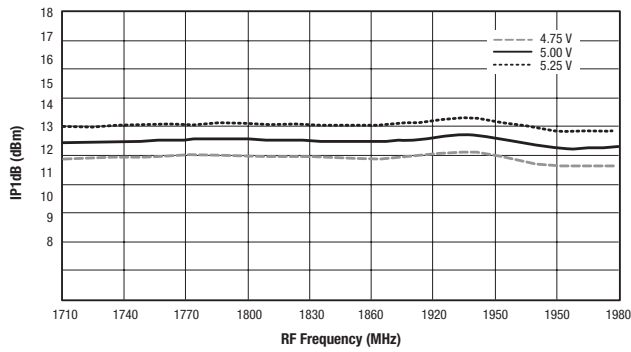

Figure 17. Mixer IP1dB vs Frequency and Supply Voltage

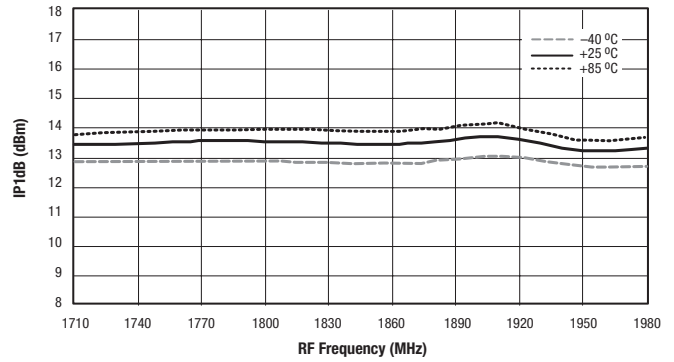

Figure 18. Mixer IP1dB vs Frequency and Temperature

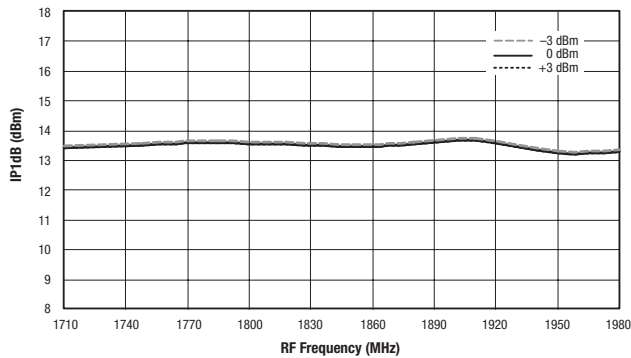

Figure 19. Mixer IP1dB vs Frequency and LO Power

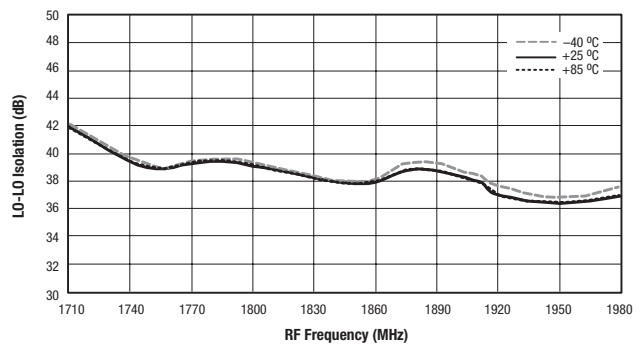

Figure 20. Mixer LO1 to LO2 Isolation vs Frequency and Temperature

Evaluation Board Description

The SKY73033-11 Evaluation Board is used to test the performance of the SKY73033-11 downconversion mixer. An assembly drawing for the Evaluation Board is shown in Figure 21 and the layer detail is provided in Figure 22.

Circuit Design Configurations

The following design considerations are general in nature and must be followed regardless of final use or configuration:

1. Paths to ground should be made as short and as low impedance as possible.
2. The ground pad of the SKY73033-11 provides critical electrical and thermal functionality. This pad is the main thermal conduit for heat dissipation. Since the circuit board acts as the heat sink, it must shunt as much heat as possible from the device. Therefore, design the connection to the ground pad to dissipate the maximum heat produced by the circuit board. For more information on soldering the

SKY73033-11, refer to the Package and Handling Information section of this Data Sheet.

3. Skyworks recommends including external bypass capacitors on the VCC voltage inputs of the device.
4. Components L5 and L4 (see Figure 23) are high-Q, low loss inductors. These inductors must be able to pass currents in excess of 200 mA DC.
5. Components R7 and R8 (see Figure 23) allow for external adjustment of the IF amplifier bias points. To reduce the IF amplifier bias current, connect pin 20 to ground through external resistor R8. To increase the IF amplifier bias current, connect pin 20 to VCC through external resistor R7. For operation as specified in Tables 3 and 4, these resistors are not required.

A schematic diagram for the SKY73033-11 Evaluation Board is shown in Figure 23.

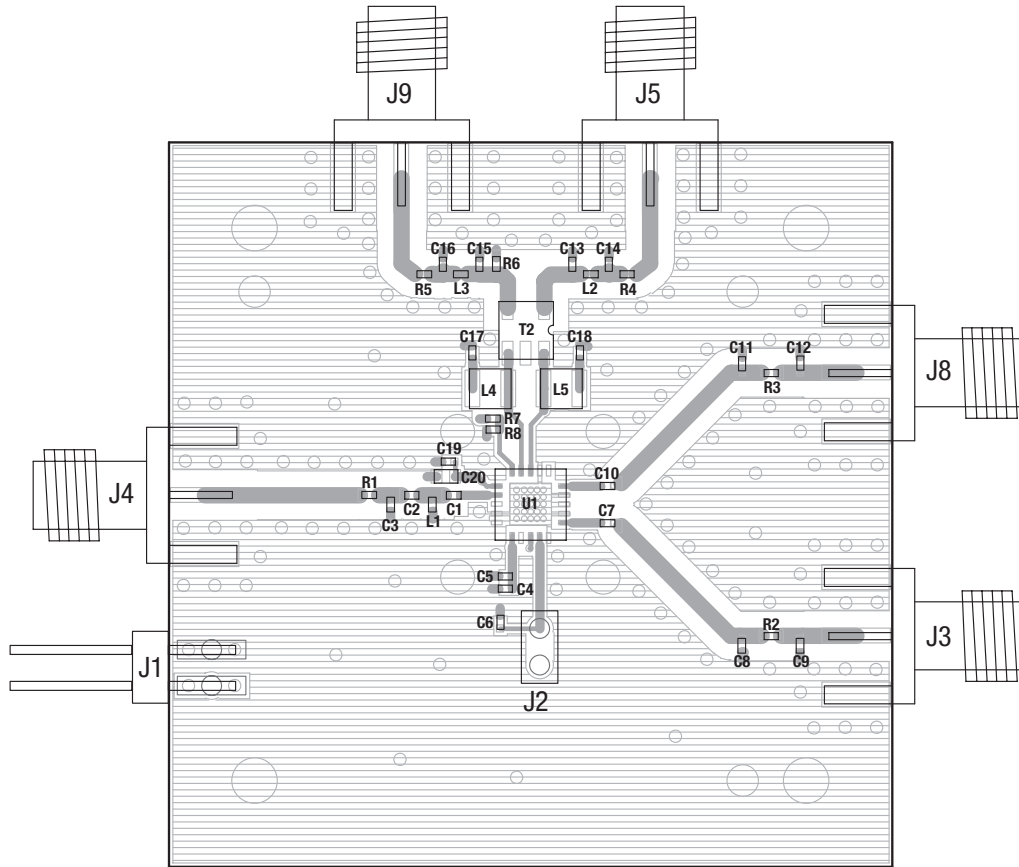

Note: This Evaluation Board is used for several different Skyworks devices.
 Components C3, C4, C6, C8, C9, C13, C15 through C19, R5, and L3 are not used for the device described by this Data Sheet.

S1214

Figure 21. SKY73033-11 Evaluation Board Assembly Diagram

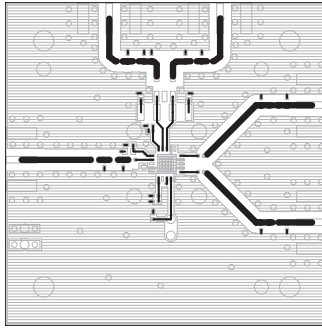

Layer 1: Top – Metal

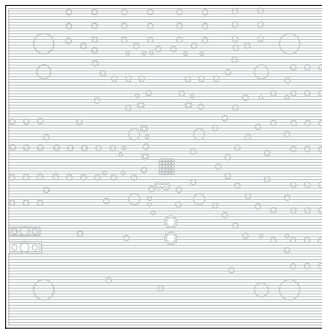

Layer 2: Ground

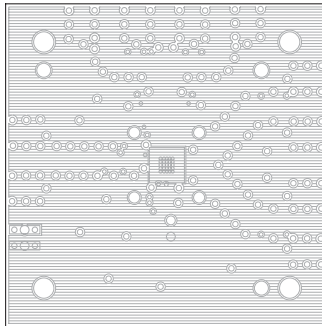

Layer 3: Power Plane

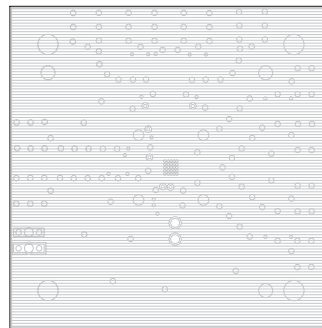

Layer 4: Solid Ground Plane

S940

Figure 22. SKY73033-11 Evaluation Board Layer Detail

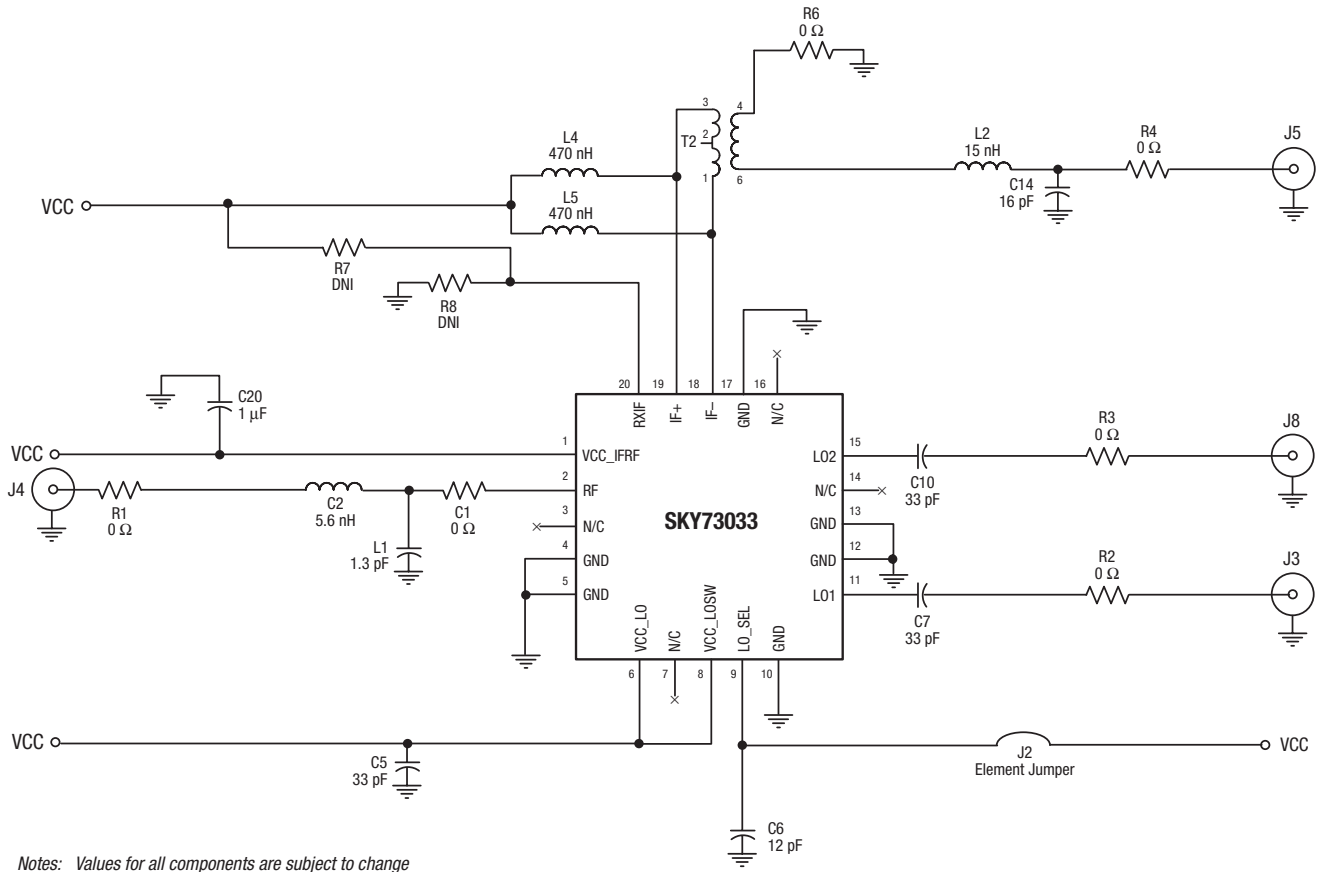

S948

Figure 23. SKY73033-11 Evaluation Board Schematic

Package Dimensions

Figure 24 shows the package dimensions for the 20-pin MCM, and Figure 25 provides the tape and reel dimensions.

Package and Handling Information

Since the device package is sensitive to moisture absorption, it is baked and vacuum packed before shipping. Instructions on the shipping container label regarding exposure to moisture after the container seal is broken must be followed. Otherwise, problems related to moisture absorption may occur when the part is subjected to high temperature during solder assembly.

THE SKY73033-11 is rated to Moisture Sensitivity Level 3 (MSL3) at 260 °C. It can be used for lead or lead-free soldering. For additional information, refer to the Skyworks Application Note, *PCB Design & SMT Assembly/Rework Guidelines for MCM-L Packages*, document number 101752.

Care must be taken when attaching this product, whether it is done manually or in a production solder reflow environment. Production quantities of this product are shipped in a standard tape and reel format. For packaging details, refer to the Skyworks Application Note, *Tape and Reel Information – RF Modules*, document number 101568.

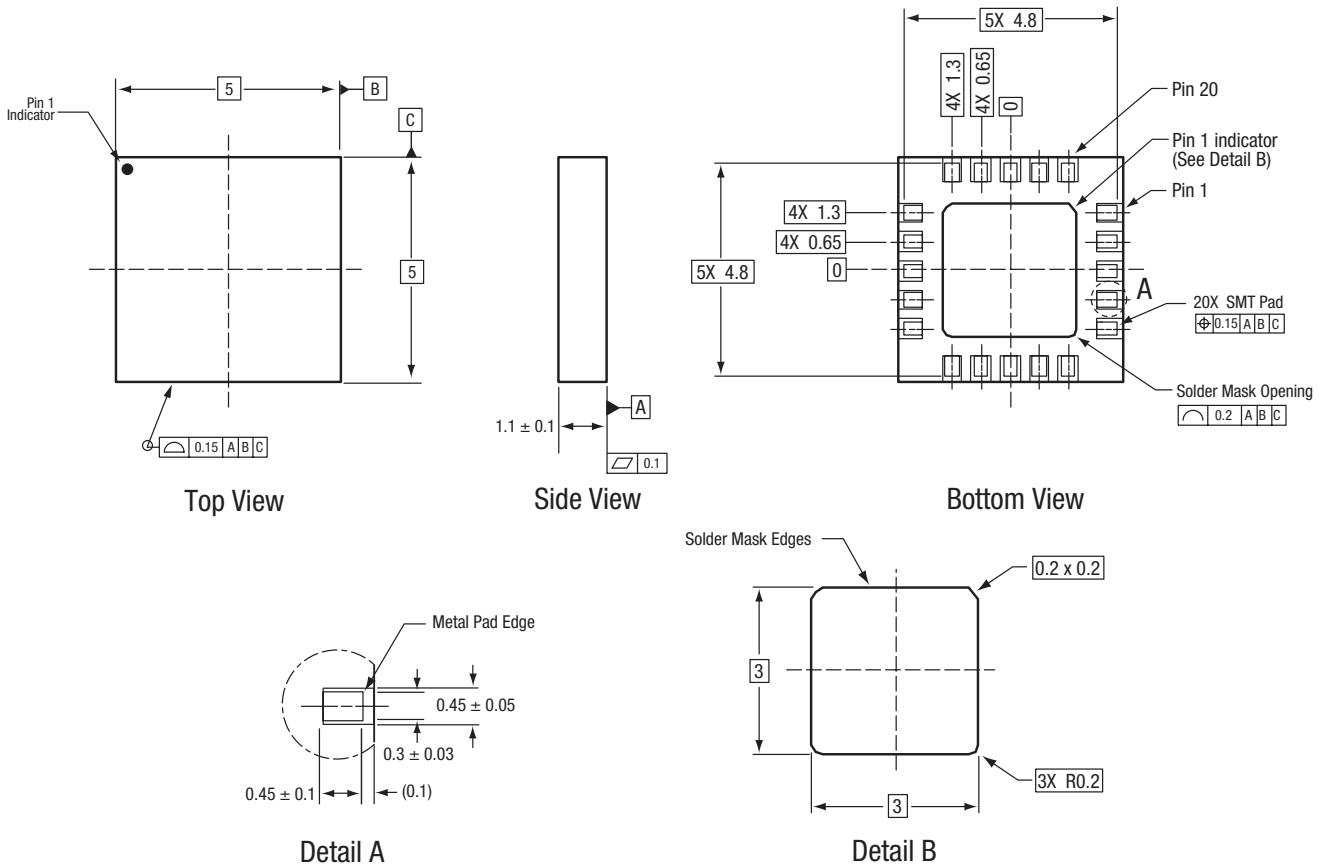

All measurements are in millimeters.
Dimensioning and tolerancing according to ASME Y14.5M-1994.

S944

Figure 24. SKY73033-11 20-Pin MCM Package Dimensions

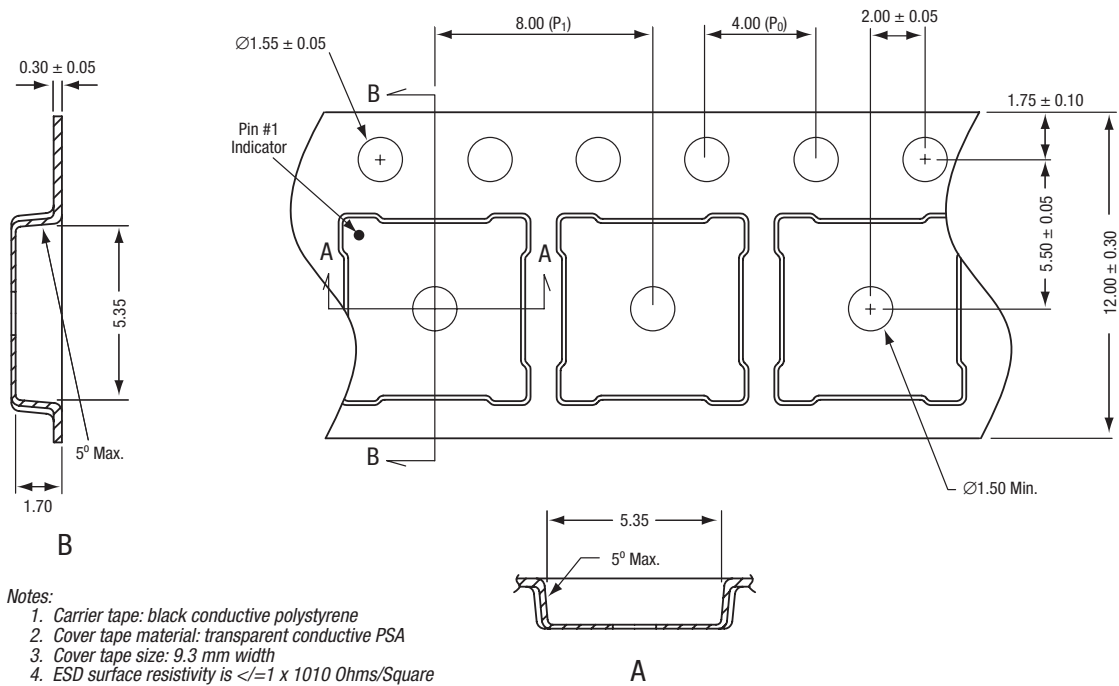

- Notes:
1. Carrier tape: black conductive polystyrene
 2. Cover tape material: transparent conductive PSA
 3. Cover tape size: 9.3 mm width
 4. ESD surface resistivity is $\leq 1 \times 10^{10}$ Ohms/Square according to EIA, JEDIC TNR specification.
 5. P_0/P_1 10 pitches cumulative tolerance on tape: ± 0.20 mm
 6. A and B measurement points are 0.30 mm from bottom pocket.
 7. All dimensions are in millimeters

S461

Figure 25. SKY73033-11 Tape and Reel Dimensions

Ordering Information

Model Name	Manufacturing Part Number	Evaluation Kit Part Number
SKY73033-11 1700-2200 MHz Downconversion Mixer	SKY73033-11 (Pb-free package)	TW17-D580

Copyright © 2007, 2008, 2009 Skyworks Solutions, Inc. All Rights Reserved.

Information in this document is provided in connection with Skyworks Solutions, Inc. ("Skyworks") products or services. These materials, including the information contained herein, are provided by Skyworks as a service to its customers and may be used for informational purposes only by the customer. Skyworks assumes no responsibility for errors or omissions in these materials or the information contained herein. Skyworks may change its documentation, products, services, specifications or product descriptions at any time, without notice. Skyworks makes no commitment to update the materials or information and shall have no responsibility whatsoever for conflicts, incompatibilities, or other difficulties arising from any future changes.

No license, whether express, implied, by estoppel or otherwise, is granted to any intellectual property rights by this document. Skyworks assumes no liability for any materials, products or information provided hereunder, including the sale, distribution, reproduction or use of Skyworks products, information or materials, except as may be provided in Skyworks Terms and Conditions of Sale.

THE MATERIALS, PRODUCTS AND INFORMATION ARE PROVIDED "AS IS" WITHOUT WARRANTY OF ANY KIND, WHETHER EXPRESS, IMPLIED, STATUTORY, OR OTHERWISE, INCLUDING FITNESS FOR A PARTICULAR PURPOSE OR USE, MERCHANTABILITY, PERFORMANCE, QUALITY OR NON-INFRINGEMENT OF ANY INTELLECTUAL PROPERTY RIGHT; ALL SUCH WARRANTIES ARE HEREBY EXPRESSLY DISCLAIMED. SKYWORKS DOES NOT WARRANT THE ACCURACY OR COMPLETENESS OF THE INFORMATION, TEXT, GRAPHICS OR OTHER ITEMS CONTAINED WITHIN THESE MATERIALS. SKYWORKS SHALL NOT BE LIABLE FOR ANY DAMAGES, INCLUDING BUT NOT LIMITED TO ANY SPECIAL, INDIRECT, INCIDENTAL, STATUTORY, OR CONSEQUENTIAL DAMAGES, INCLUDING WITHOUT LIMITATION, LOST REVENUES OR LOST PROFITS THAT MAY RESULT FROM THE USE OF THE MATERIALS OR INFORMATION, WHETHER OR NOT THE RECIPIENT OF MATERIALS HAS BEEN ADVISED OF THE POSSIBILITY OF SUCH DAMAGE.

Skyworks products are not intended for use in medical, lifesaving or life-sustaining applications, or other equipment in which the failure of the Skyworks products could lead to personal injury, death, physical or environmental damage. Skyworks customers using or selling Skyworks products for use in such applications do so at their own risk and agree to fully indemnify Skyworks for any damages resulting from such improper use or sale.

Customers are responsible for their products and applications using Skyworks products, which may deviate from published specifications as a result of design defects, errors, or operation of products outside of published parameters or design specifications. Customers should include design and operating safeguards to minimize these and other risks. Skyworks assumes no liability for applications assistance, customer product design, or damage to any equipment resulting from the use of Skyworks products outside of stated published specifications or parameters.

Skyworks, the Skyworks symbol, and "Breakthrough Simplicity" are trademarks or registered trademarks of Skyworks Solutions, Inc., in the United States and other countries. Third-party brands and names are for identification purposes only, and are the property of their respective owners. Additional information, including relevant terms and conditions, posted at www.skyworksinc.com, are incorporated by reference.