

DATA SHEET

SKY73103-11: 1460-1665 MHz High Performance VCO/Synthesizer With Integrated Switch

Applications

- 2G, 2.5G, and 3G base station transceivers:
 - GSM, EDGE, CDMA, WCDMA
- General purpose RF systems

Features

- Wideband frequency operation: 1460 to 1665 MHz
- Process-tolerant compensation for VCO
- 24-bit $\Sigma\Delta$ fractional-N synthesizer
- Ultra-fine frequency resolution of 0.001 ppm
- Flexible reference frequency selection
- Three-wire serial interface up to 20 MHz clock frequency
- Integrated PLL supply regulation for spur isolation
- MCM (38-pin, 9 x 12 mm) SMT package (MSL3, 260 °C per JEDEC J-STD-020)

NEW

Skyworks offers lead (Pb)-free, RoHS (Restriction of Hazardous Substances) compliant packaging.



Description

Skyworks SKY73103-11 Voltage-Controlled Oscillator (VCO)/Synthesizer is a fully integrated, high performance signal source for high dynamic range transceivers. The device provides ultra-fine frequency resolution, fast switching speed, and low phase noise performance for 2G, 2.5G, and 3G base station transceivers.

The SKY73103-11 VCO/Synthesizer is a key building block for high-performance radio system designs that require low power and a fine step size. Reference clock generators with an output frequency up to 52 MHz can be used with the SKY73103-11. The input clock frequency is divided down by programmable dividers (1 to 8) for the synthesizer. The phase detector can operate at a maximum speed of 26 MHz, which allows better phase noise due to the lower division value.

The SKY73103-11 VCO/Synthesizer is provided in a compact, 38-pin Multi-Chip Module (MCM). The device package and pinout are shown in Figure 1. A functional block diagram is shown in Figure 2. Signal pin assignments and functional pin descriptions are provided in Table 1.

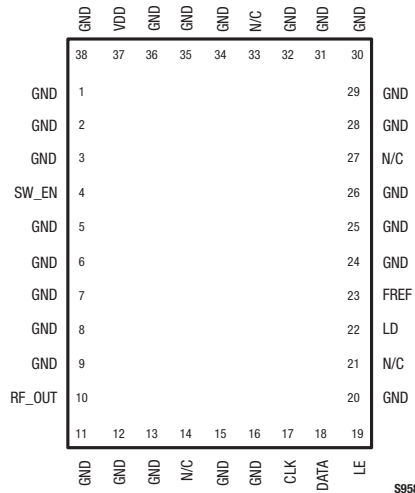
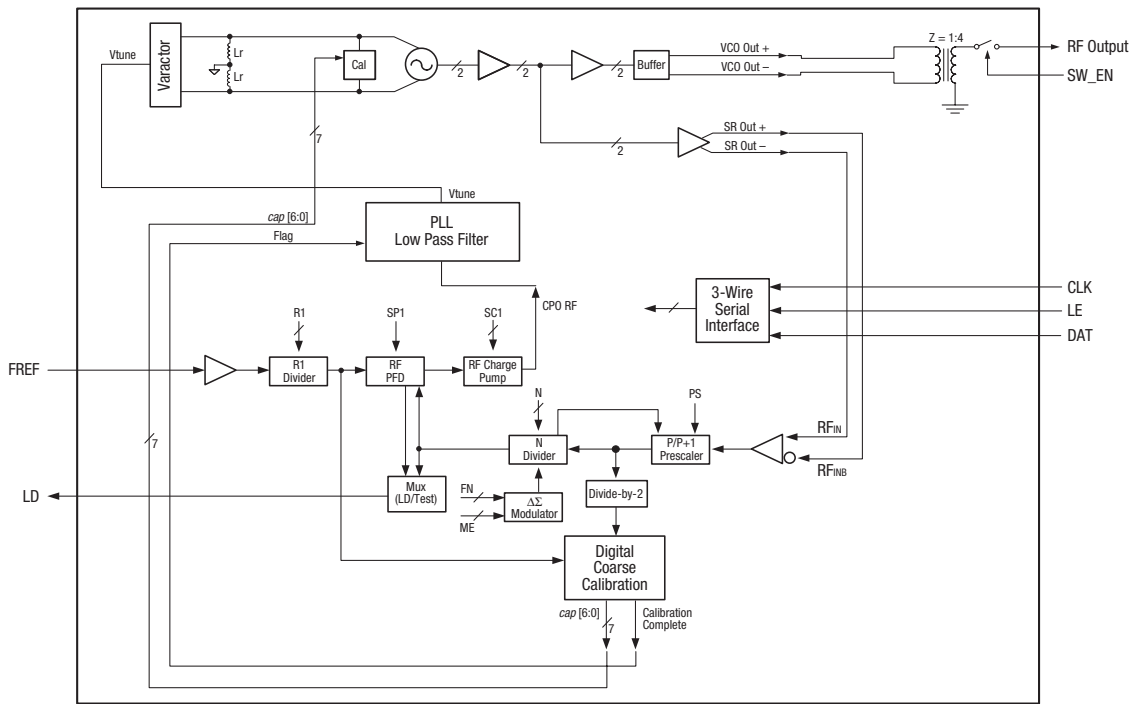

Figure 1. SKY73103-11 Pinout– 38-Pin MCM Package (Top View)



S1040

Figure 2. SKY73103-11 Functional Block Diagram

Table 1. SKY73103-11 Signal Descriptions

Pin #	Name	Description	Pin #	Name	Description
1	GND	Ground	20	GND	Ground
2	GND	Ground	21	N/C	No connection
3	GND	Ground	22	LD	Lock detect output
4	SW_EN	Synthesizer RF output switch enable	23	FREF	Frequency reference input
5	GND	Ground	24	GND	Ground
6	GND	Ground	25	GND	Ground
7	GND	Ground	26	GND	Ground
8	GND	Ground	27	N/C	No connection
9	GND	Ground	28	GND	Ground
10	RF_OUT	Synthesizer output	29	GND	Ground
11	GND	Ground	30	GND	Ground
12	GND	Ground	31	GND	Ground
13	GND	Ground	32	GND	Ground
14	N/C	No connection	33	N/C	No connection
15	GND	Ground	34	GND	Ground
16	GND	Ground	35	GND	Ground
17	CLK	Serial port clock	36	GND	Ground
18	DATA	Serial port data	37	VDD	+5 V power supply
19	LE	Serial port latch enable	38	GND	Ground

Technical Description

The SKY73103-11 is a fractional-N frequency synthesizer using a $\Sigma\Delta$ modulation technique. The fractional-N implementation provides low in-band noise by having a low division and fast frequency settling time. The device also provides programmable, arbitrary fine frequency resolution. This compensates the frequency synthesizer for crystal frequency drift.

Serial I/O Control Interface

The SKY73103-11 is programmed through a three-wire serial bus control interface. The three-wire interface consists of three signals: CLK (pin 17), LE (pin 19), and the bit serial data line DATA (pin 18). A serial data input timing diagram is shown in Figure 3. Timing parameter values are provided in Table 2.

Although the SKY73103-11 uses a 5 V DC supply, the internal voltage regulator has a 3.3 V output for the Phase Locked Loop (PLL). Therefore, the input DC voltage for the CLK, DATA, and LE signals should be set ≤ 3.3 V.

Figure 4 depicts the serial bus, which consists of one 26-bit load register and four separate 24-bit hold registers. Data is initially clocked into the load register starting with the Most Significant Bit (MSB) and ending with the Least Significant Bit (LSB).

The LE signal is used to gate the clock to the load register, requiring the LE signal to be brought low before the data load. Data is shifted on the rising edge of CLK. The falling edge of LE latches the data into the appropriate hold register from the load register. This programming sequence must be repeated to fill all four hold registers.

The specific hold register addresses are determined by the wd_0 and wd_1 parameters in the load register. These are the two LSBs (bits [1:0]) as shown in Figure 4. Table 3 lists the four hold registers and their respective addresses as determined in the load register.

The contents of each word in the load register are used to program the four hold registers described in Tables 4 through 7. The dpll_ctrl parameter (bits [19:2] of Word 1) programs the

Digital Phase Locked Loop (DPLL) block. Each of the 18 bits that comprise the dpll_ctrl parameter map directly to the signal ports on the DPLL block as shown in Table 8 (except for the dpll_flag_override and dpll_flag_value parameters).

Loading new data into a hold register not associated with the synthesizer frequency programming does not reset or change the synthesizer. The synthesizer should not lose lock before, during, or after a new serial word load that does not change the programmed frequency.

VCO Auto-Tuning Loop

An auto-tuning loop provides the proper 7-bit coarse tuning setting for the switch capacitors in the VCO tank circuits. This sets the oscillation frequency as close to target as possible before starting fine analog tuning.

The auto-tuning loop is designed to compensate for process variation so that the VCO fine tuning range can be reduced to cover minor variations only. The auto-tuning loop reduces VCO gain (Kv), which reduces the VCO phase noise.

The loop includes an analog part and a digital part (referred to as the DPLL). The analog part includes the VCO, a high-speed divider, and a VCO tuning voltage control block. The high-speed divider consists of the prescaler (divide by 16/17 or divide by 8/9) followed by an additional divide-by-2 block to generate the low frequency internal signal, vco_clk.

There are two conditions that enable the VCO auto-tuning function: a Power-On-Reset (POR) and a change in frequency. The difference in the program flow under each of these conditions is illustrated in Figure 5. Under either condition, dpll_en (bit [20] of Word 1) should first be cleared so that a rising edge pulse can be generated. Following this pulse, set dpll_en to enable VCO auto-tuning.

A POR timing diagram is shown in Figure 6. Auto-tuning details in the frequency and time domains for the VCO are shown in Figure 7.

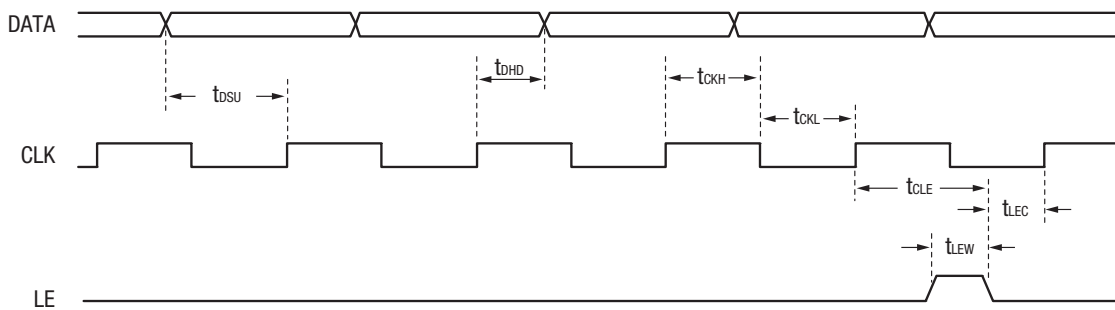

S1053

Figure 3. SKY73103-11 Serial Data Input Timing Diagram (MSB First)

Table 2. CLK, DATA, LE Timing Parameters

Parameter	Value
Input high voltage (V _{IH})	1.6 V
Input low voltage (V _{IL})	0.3 V
Input current (I _{DIG})	1 μA (maximum)
Clock frequency	15 MHz (maximum)
Clock high (t _{CKH})	15 ns (minimum)
Clock low (t _{CKL})	15 ns (minimum)
Data set up (t _{DSU})	20 ns (minimum)
Data hold (t _{DH})	10 ns (minimum)
Clock to latch enable (t _{CLE})	20 ns (minimum)
Latch enable width (t _{LEW})	15 ns (minimum)
Latch enable to clock (t _{LEC})	15 ns (minimum)
Word length	26 bits
Number of words	4
Current drain	2 μA

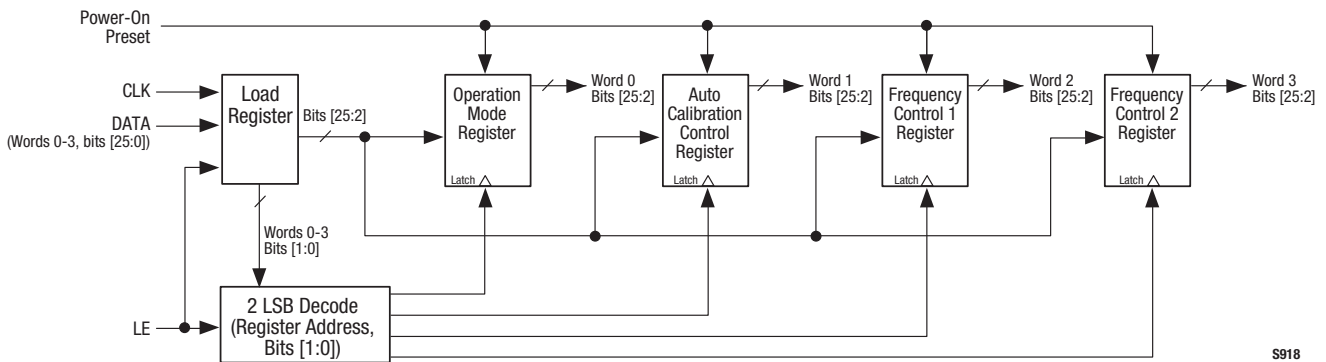

Figure 4. Serial Bus Block Diagram

Table 3. SKY73103-11 Hold Registers and Addresses

Hold Register Name	Hold Register Address (Binary) in Load Register Words	
	Bit [1]	Bit [0]
Operation Mode	0	0
Auto Calibration Control	0	1
Frequency Control 1	1	0
Frequency Control 2	1	1

Table 4. Load Register Word 0 (Programs the Operation Mode Register) (1 of 2)

Parameter	Function	State Description	Recommended Operational Value (Binary)
wd_0, wd_1	Address bits [1:0]. Must be set to 00b (see Table 3)		00
cp_output	Charge pump setting [4:2]	Bits [4:2]: 0 0 0 = 200 μ A 0 0 1 = 400 μ A 0 1 0 = 600 μ A 0 1 1 = 800 μ A 1 0 0 = 1000 μ A 1 0 1 = 1200 μ A 1 1 0 = 1400 μ A 1 1 1 = 1600 μ A	Application dependent (see Table 11)
cp_delay	Charge pump delay [6:5]	Bits [6:5]: 0 0 = 2 nsec 0 1 = 4 nsec 1 0 = 7 nsec 1 1 = 9 nsec	00
pd_polar	Polarity of phase detector [7]	Bit [7]: 0 = negative 1 = positive	0
cp_tristate	Tri-state selection for the transmit PLL charge pump output [8]	Bit [8]: 0 = charge pump in normal functional mode 1 = charge pump disabled/tri-stated	0
rsvd	Reserved [9]	Reserved	0
sd_sel	Internal operating voltage control bit for $\Sigma\Delta$ synthesizer [10] Note: this bit needs to be programmed together with bits [11] and [12].	Bit [12] Bit [11] Bit [10]: N-Cntr/R-Divider Voltage Mod Dig Voltage 0 X X = 0 V 0 V 1 0 0 = 1.8 V 1.8 V 1 0 1 = 1.8 V 2.4 V 1 1 0 = 2.4 V 1.8 V 1 1 1 = 2.4 V 2.4 V	100
nr_sel	Internal operating voltage control bit for N-counter and R-divider [11] See sd_sel parameter (bit [10])	This bit needs to be programmed together with bits [10] and [12].	–
pll_en	Internal operating voltage control bit for PLL [12] See sd_sel parameter (bit [10])	This bit needs to be programmed together with bits [10] and [11].	–
ref_bw_sel	Reference buffer bandwidth [14:13]	Bits [14:13]: 0 0 = 20 MHz 0 1 = 30 MHz 1 0 = 40 MHz 1 1 = 50 MHz	Application dependent (see Table 11)
test_mux	Lock detect and diagnostic output select [17:15]	Bits [17:15]: 0 0 0 = lock detect output 0 0 1 = R-divider output 0 1 0 = N-divider output 0 1 1 = not used 1 0 0 = not used 1 0 1 = not used 1 1 0 = not used 1 1 1 = DPLL test	000

Table 4. Load Register Word 0 (Programs the Operation Mode Register) (2 of 2)

Parameter	Function	State Description	Recommended Operational Value (Binary)
rsvd	Reserved [20:18]	Reserved	000
pre_curr_sel	Prescaler current bias [22:21]	Bits [22:21]: 0 0 = 20 μ A 0 1 = 22 μ A 1 0 = 24 μ A 1 1 = 26 μ A	00
prescale_sel	Prescaler mode select [23]	Bit [23]: 0 = Prescaler in 8/9 divide mode 1 = Prescaler in 16/17 divide mode	Application dependent (see Table 11)
rsvd	Reserved [25:24]	Reserved	00

Table 5. Load Register Word 1 (Programs the Auto Calibration Control Register)

Parameter	Function	State Description	Recommended Operational Value (Binary)
wd_0, wd_1	Address bits [1:0]. Must be set to 01b (see Table 3)		01
dpll_ctrl	DPLL control [19:2]	Refer to Table 8	–
dpll_en	VCO auto tuning enable flag [20]	0 = disable VCO auto tuning 1 = enable VCO auto tuning	Refer to Figure 5
rsvd	Reserved [25:21]	Reserved	00000

Table 6. Load Register Word 2 (Programs the Frequency Control 1 Register) (1 of 2)

Parameter	Function	State Description	Recommended Operational Value (Binary)
wd_0, wd_1	Address bits [1:0]. Must be set to 10b (see Table 3)		10
rdiv	Reference divider ratio [3:2]	Bits [3:2]: 0 0 = 8 0 1 = 4 1 0 = 2 1 1 = 1	Application dependent (see Table 11)
rsvd	Reserved [5:4]	Reserved	–
ndiv	N-divider/prescaler mode for control of M and A counters [15:6]	Bits [15:10] Bits [9:6] M bits [5:0] A bits [3:0] = use 16/17 prescaler M bits [5:0] A bits [2:0] = use 8/9 prescaler Note: The six MSBs of ndiv denote the M counter value and the four LSBs denote the A counter value. For the 8/9 prescaler mode, the A counter value requires only three bits. Therefore, bit [9] of ndiv is a “don’t care” bit.	Application dependent
rsvd	Reserved [16]	Reserved	0

Table 6. Load Register Word 2 (Programs the Frequency Control 1 Register) (2 of 2)

Parameter	Function	State Description	Recommended Operational Value (Binary)
mod_reset_f	Modulator reset/fractional mode select [17]	Bit [17]: 0 = modulator is reset or disabled 1 = modulator is in fractional mode	1
fract_int_sel	Fractional/integer mode select [18]	Bit [18]: 0 = modulator is in integer mode 1 = modulator is in functional mode	1
rsvd	Reserved [19]	Reserved. This bit should always remain set (logic high).	1
me	Modulus extender [23:20]	These four bits need to be programmed together with bits [12:2] of Word 3. Bits [23:20] represent the four LSBs ([3:0]) of the 15-bit modulus extender value (ME [14:0]). Refer to the Synthesizer Programming section of this Data Sheet for further information.	Application dependent
rsvd	Reserved [25:24]	Reserved	00

Table 7. Load Register Word 3 (Programs the Frequency Control 2 Register)

Parameter	Function	State Description	Recommended Operational Value (Binary)
wd_0, wd_1	Address bits [1:0]. Must be set to 11b (see Table 3)		11
me	Modulus extender [12:2]	These 11 bits need to be programmed together with bits [23:20] of Word 2. Bits [12:2] represent the 11 MSBs ([14:4]) of the 15-bit modulus extender value (ME [14:0]). Refer to the Synthesizer Programming section of this Data Sheet for further information.	Application dependent
fn	Fractional divisor code [20:13]	Bits [20:13] represent the 8-bit fractional divisor code (FN [7:0]). Refer to the Synthesizer Programming section of this Data Sheet for information.	Application dependent
rsvd	Reserved [23:21]	These three bits should always remain cleared (logic low).	0
rsvd	Reserved [25:24]	Reserved	00

Table 8. DPLL Signal Mapping

Serial Port Name	Load Register Word 1 Bit	Recommended Operation Value
dp11_clk_dly(0)	2	0
dp11_clk_dly(1)	3	0
dp11_temp_comp(0)	4	0
dp11_temp_comp(1)	5	0
dp11_temp_comp(2)	6	0
dp11_temp_comp(3)	7	0
dp11_temp_comp(4)	8	0
dp11_temp_comp_en	9	0
dp11_ext_test(0)	10	0
dp11_ext_test(1)	11	0
dp11_ext_test(2)	12	0
dp11_ext_test(3)	13	0
dp11_ext_test(4)	14	0
dp11_ext_test(5)	15	0
dp11_ext_test(6)	16	0
dp11_ext_test(7)	17	0
dp11_flag_override	18	0
dp11_flag_value	19	0

VCO Prescalers

The VCO prescalers divide the VCO output signal by either 16/17 or 8/9. The $\Sigma\Delta$ modulator determines whether to divide by 16 or 17 in the 16/17 mode, or whether to divide by 8 or 9 in the 8/9 mode. The prescaler mode is determined by bit [23] of Word 0 (Operation Mode Register).

N-Counter

The N-counter consists of two asynchronous ripple counters, a 6-bit M-counter and a 4-bit A-counter. The M-counter determines the counts using the lower division ratio in the prescaler (8 or 16); the A-counter determines the counts using the upper division ratio (9 or 17).

By changing the counter setting at each reference clock cycle, the Modulated Fractional Divider (MFD) achieves the desired noise shaping.

VCO MFD Block

The MFD block divides down the prescaler output to the internal PLL comparison frequency. A third order cascaded $\Sigma\Delta$ modulation technique minimizes spurs through randomization of the division ratio.

The MFD block controls the division ratio by dynamically programming the M and A counters.

Phase Detector and Charge Pump

The phase detector and charge pump detect and integrate the phase and frequency errors of the divided-down VCO output versus the reference clock. This results in a feedback adjustment of the control voltage for the VCO.

Lock Detect

Lock detection circuitry provides a CMOS logic level indication when the PLL is frequency locked (high when locked).

Reference Input Divider

The R-counter (reference input clock divider) consists of three divide-by-two blocks and one multiplexer controlled by the *rdiv* parameter in Word 2 (Frequency Control 1 Register). The R-counter is used to select a divide-by-one or a divide-by-eight function.

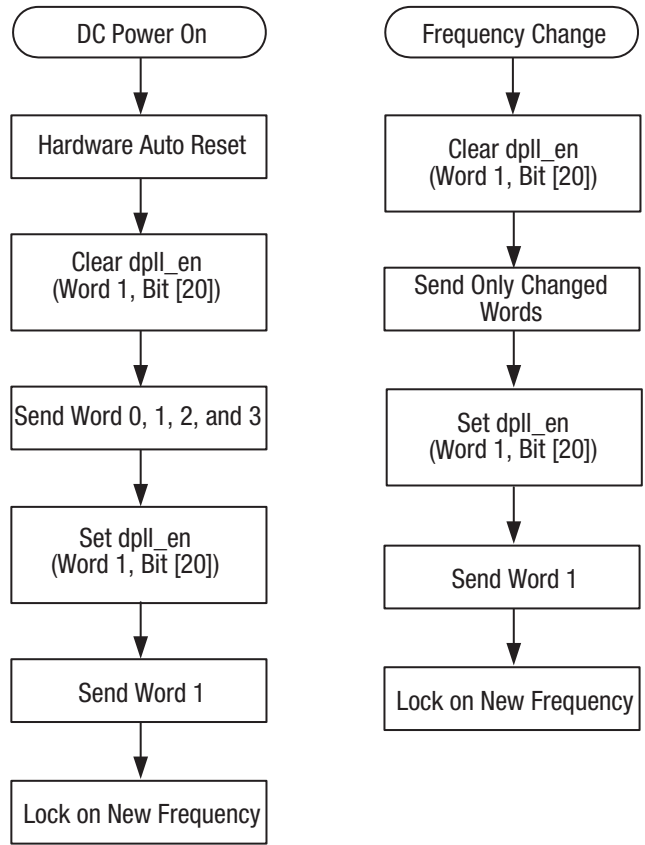

S998

Figure 5. VCO Auto-Tuning Enable Process Flow Due to POR or Frequency Change

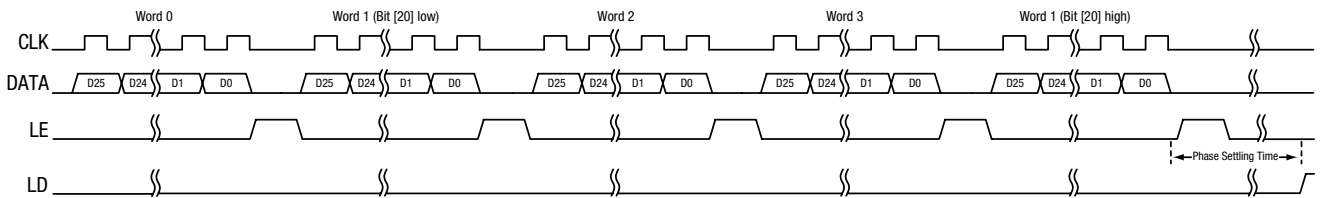

S1296

Figure 6. POR Timing Diagram

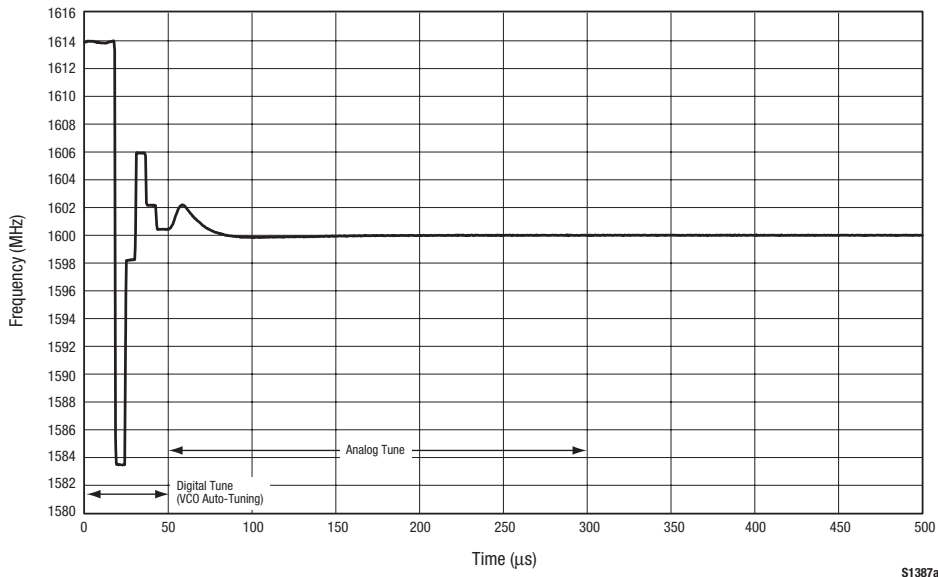

Figure 7. VCO Auto-Tuning @ 1600 MHz Frequency Settling

Synthesizer Output Switch

An on-chip switch is integrated into the SKY73103-11 RF output after the balun and is controlled by the SW_EN signal (pin 4) as indicated below:

SW_EN Input	Synthesizer Output
High	On
Low	Off

The switch provides >50 dB isolation at the synthesizer RF output. This allows the SKY73103-11 to be used for GSM applications.

Synthesizer Programming

To program the synthesizer to the correct frequency, values for the N-counter (both M and A portions), fractional divisor (FN), and fractional modulus extender (ME) are needed. These values are used to determine the total divider ratio, D_{Total} , according to Equation 1:

$$D_{Total} = N_{actual} + FN_{actual} + ME_{actual} + 3.5 \tag{1}$$

Where: N_{actual} = the actual value of the N-counter

FN_{actual} = the actual fractional divisor

ME_{actual} = the actual fractional modulus extender

Because of the way the $\Delta\Sigma$ modulator is implemented in the SKY73103-11, the number 3.5 must be added to the division number to obtain the final division ratio.

The calculated value for D_{Total} can then be used to determine the correct synthesizer frequency, RF :

$$RF = \frac{F_{REF}}{R1} \times D_{Total} \tag{2}$$

Where: F_{REF} = the reference frequency

$R1$ = the reference divider ratio

The 6-bit M-counter and the 4-bit A-counter portions of the N-counter are calculated according to the following relationships:

N_{actual} is the actual N-counter value and is the integer portion of $(D_{Total} - 3.5)$:

$$N_{actual} = M_{actual} \times P + A_{actual} \tag{3}$$

If: $M = M_{actual}$ (binary number, fit to six bits)

$A = A_{actual}$ (binary number, fit to four bits)

Then: $N = M \times 2^4 + A$

Where: N is the number to be programmed into the N-counter.

The synthesizer has a selectable prescaler of 8/9 or 16/17. If the 16/17 prescaler is used:

$$P = 2^4 = 16$$

In this case, N is the same as N_{actual} , M is equal to the six MSBs of N_{actual} , and A is equal to the four LSBs of N_{actual} .

If the 8/9 prescaler is used:

$$P = 8$$

Here, N is not equal to N_{actual} . The A-counter portion only uses the three LSBs (the 4th bit of the A-counter is a “don’t care” bit).

The fractional divisor code (FN) sets the fractional-N modulo up to 256 modulo according to the following equation:

$$FN_{actual} = D_7 \left(\frac{1}{2} \right) + D_6 \left(\frac{1}{2^2} \right) + D_5 \left(\frac{1}{2^3} \right) + \dots + D_0 \left(\frac{1}{2^8} \right) \quad (4)$$

The value of FN is equal to the binary representation of 256 (or 2^8) $\times FN_{actual}$, or:

$$FN = D_7 \times 2^7 + D_6 \times 2^6 + D_5 \times 2^5 + \dots + D_0$$

The fractional modulo can be extended up to 2^{23} using the modulo extender (ME) if required:

$$ME_{actual} = D_{14} (1/2^9) + D_{13} (1/2^{10}) + D_{12} (1/2^{11}) + \dots + D_0 (1/2^{23})$$

The value of ME is equal to the binary representation of the integer part of $2^{23} \times ME_{actual}$, or:

$$ME = D_{14} \times 2^{14} + D_{13} \times 2^{13} + D_{12} \times 2^{12} + \dots + D_0$$

Example:

A desired synthesizer frequency of 1537.25 MHz is required using a crystal frequency of 16 MHz and a 16/17 prescaler. Since the maximum internal reference frequency is 25 MHz, the crystal frequency does not need to be divided. However, a reference divider ratio of 2 is used for this example.

Restating Equation 2 as a function of D_{Total} :

$$D_{Total} = (1537.26 \times 2) / 16 = 192.1575$$

Where: $RF = 1537.26$

$$R1 = 2$$

$$F_{REF} = 16$$

Determine N_{actual} by subtracting 3.5 from D_{Total} and removing the fractional portion:

$$D_{Total} - 3.5 = 188.6575$$

Using Equation 3:

$$N_{actual} = 188 = M_{actual} \times P + A_{actual}$$

Where: $M_{actual} = 11$

$$P = 16$$

$$A_{actual} = 12$$

$M = M_{actual} = 11 = 001011b$ (the six MSBs)

$A = A_{actual} = 12 = 1100b$ (the four LSBs)

$N = M \times 2^4 + A = 0010111100b$ (this is the same as N_{actual})

Multiply the fractional portion that was removed in the previous step by 256 and remove the fractional portion of the result to determine FN :

$$0.6575 \times 256 = 168.32$$

$$FN = 168 = 10101000b$$

Divide FN by 256 to determine the actual fractional part, FN_{actual} :

$$FN_{actual} = 168/256 = 0.65625$$

Subtract this result from the fractional portion of ($D_{Total} - 3.5$) to determine the actual fractional modulus extender, ME_{actual} :

$$\begin{aligned} ME_{actual} &= (D_{Total} - 3.5 - N_{actual}) - FN_{actual} \\ &= 0.6575 - 0.65625 \\ &= 0.00125 \end{aligned}$$

Multiply this result by 8388608 (the 23-bit $\Delta\Sigma$ modulator value, 2^{23}) and remove the fractional portion to determine the value of ME :

$$0.00125 \times 8388608 = 10485.76$$

$$ME = 10485 = 010100011110101b$$

Package and Handling Information

Since the device package is sensitive to moisture absorption, it is baked and vacuum packed before shipping. Instructions on the shipping container label regarding exposure to moisture after the container seal is broken must be followed. Otherwise, problems related to moisture absorption may occur when the part is subjected to high temperature during solder assembly.

The SKY73103-11 is rated to Moisture Sensitivity Level 3 (MSL3) at 260 °C. It can be used for lead or lead-free soldering. For additional information, refer to Skyworks Application Note, *PCB Design and SMT Assembly/Rework Guidelines for MCM-L Packages*, document number 101752.

Care must be taken when attaching this product, whether it is done manually or in a production solder reflow environment. Production quantities of this product are shipped in a standard tape and reel format. For packaging details, refer to the Skyworks Application Note, *Tape and Reel*, document number 101568.

Circuit Design Considerations

The following design considerations are general in nature and must be followed regardless of final use or configuration

1. Paths to ground should be made as short and as low impedance as possible.
2. The ground pad of the SKY73103-11 provides critical electrical grounding requirements. Design the connection to the ground pad to provide the best electrical connection to the circuit board. Multiple vias to the grounding layer are recommended to connect the top layer ground area to the main ground layer.

3. Skyworks recommends including external bypass capacitors on the VDD voltage input (pin 37) of the device. These capacitors should be placed as close as possible to the VDD input pin.
4. A 50 Ω impedance trace is needed for the RF_OUT (pin 10) line.

Measurement plots for single sideband phase noise and settling time are shown in Figures 8 and 9, respectively.

Typical performance characteristics of the SKY73103-11 are illustrated in Figures 10 through 27.

A typical application schematic for the SKY73103-11 is provided in Figure 28. The PCB layout footprint of the SKY73103-11 is provided in Figure 29. Figure 30 shows the package dimensions for the 38-pin MCM, and Figure 31 provides the tape and reel dimensions.

Electrical and Mechanical Specifications

The absolute maximum ratings of the SKY73103-11 are provided in Table 9. The recommended operating conditions are specified in Table 10 and electrical specifications are provided in Table 11. Spur suppression measurements are provided in Table 12.

Table 9. SKY73103-11 Absolute Maximum Ratings (Note 1)

Parameter	Symbol	Min	Typical	Max	Units
Supply voltage	VCC	0		5.5	V
CLK, DATA, LE input DC voltage		0		4.6	V
Operating temperature	T _{OP}	-40		+85	°C
Storage temperature	T _{ST}	-40		+150	°C

Note 1: Exposure to maximum rating conditions for extended periods may reduce device reliability. There is no damage to device with only one parameter set at the limit and all other parameters set at or below their nominal values. Exceeding any of the limits listed here may result in permanent damage to the device.

CAUTION: Although this device is designed to be as robust as possible, Electrostatic Discharge (ESD) can damage this device. This device must be protected at all times from ESD. Static charges may easily produce potentials of several kilovolts on the human body or equipment, which can discharge without detection. Industry-standard ESD precautions should be used at all times. The SKY73103-11 threshold level is 2500 VDC using Human Body Model (HBM) testing. This level applies to RF signal lines >100 MHz, analog and RF lines <100 MHz, digital lines, power supply lines, and ground pins.

Table 10. SKY73103-11 Recommended Operating Conditions

Parameter	Symbol	Min	Typical	Max	Units
Supply voltage	VCC	4.75	5.00	5.25	V
Input voltage (CLK, DATA, LE) (Note 1): Low level High level		1.4	3.3	0.6 3.6	V V
Output voltage (LD) with 18 kΩ load from VCC PLL: Low level, unlocked High level, unlocked		2.4		0.4	V V
Reference frequency input voltage (FREF, pin 23)	FREF _{IN}	0.5	1.0	1.5	V _{p-p}
Load connected to RF output		50 Ω, maximum VSWR (load input) 2.0:1, all phases			
RF output switch enable: High Low	SWEN _H SWEN _L	2.2		0.8	V V

Note 1: The CLK, DATA, and LE signals (pins 17, 18, and 19, respectively) are internally 3.3 VDC. **DO NOT** apply 5 VDC to these pins.

Table 11. SKY73103-11 Electrical Characteristics (Note 1) (Note 2)**(VCC = 5 V, Tc = 25 °C, cp_output = 1000 μ A, FREF = 52 MHz, ref_bw_sel = 50 MHz, rdiv = 8, prescale_sel = 8/9, Unless Otherwise Noted)**

Parameter	Symbol	Test Conditions	Min	Typical	Max	Units
Oscillation frequency			1460		1665	MHz
Reference frequency	FREF			13	52	MHz
Phase detector frequency				6.5		MHz
PLL loop bandwidth				25		kHz
Output level			-12.0	-10.8	-8.0	dBm
Output impedance				50		Ω
Output VSWR					2:1	-
Reference frequency (FREF) input impedance			470			Ω
Harmonic suppression: 2 nd harmonic 3 rd harmonic				-38 -61	-33 -52	dBc dBc
Integrated RMS phase noise		100 Hz to 100 kHz			1	degrees RMS
Single sideband phase noise offset: @ 10 kHz @ 200 kHz @ 400 kHz @ 600 kHz @ 800 kHz @ 1000 kHz @ 1.8 MHz @6 MHz				-86 -126 -137 -141 -143 -148 -150 -156	-82 -120 -129 -134 -138 -142 -145 -153	dBc/Hz dBc/Hz dBc/Hz dBc/Hz dBc/Hz dBc/Hz dBc/Hz dBc/Hz
PLL-reference spurious suppression					-100	dBc
Frequency settling time		Within ± 2 kHz		215	375	μ s
Phase settling time		Within ± 5 deg		230	450	μ s
Peak phase error				2	5	degrees
Switch isolation			48	52		dB
Current consumption				114	135	mA

Note 1: Performance is guaranteed only under the conditions listed in this Table.**Note 2:** Characterized performance may change if the SKY73103-11 is configured differently than the test conditions specified here. This characterization used a 6.5 MHz fixed comparison frequency for the PLL phase loop filter. The PLL synthesizer is programmable up to a maximum comparison frequency of 26 MHz but with degraded performance.

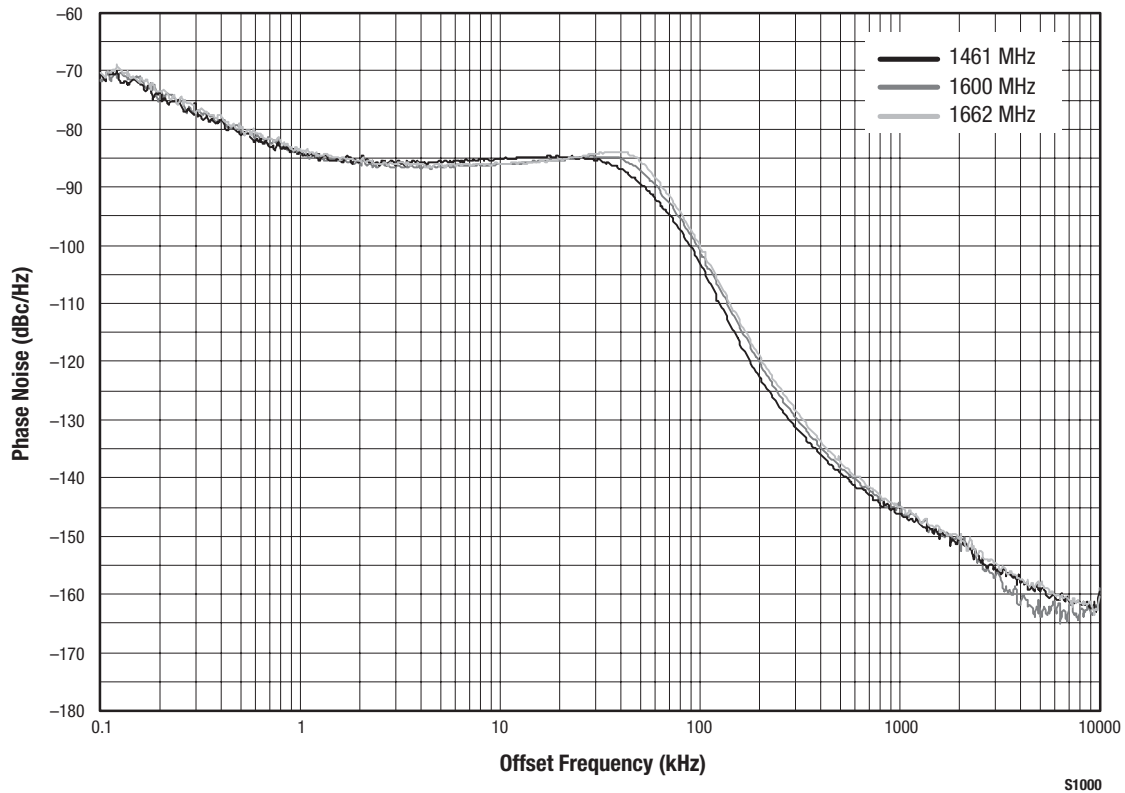

Figure 8. SKY73103-11 Single Sideband Phase Noise Measurements

Table 12. SKY73103-11 Spur Suppression Measurements
(VCC = 5 V, TC = 25 °C, cp_output = 1000 μA, FREF = 52 MHz, rdiv = 8)

Offset From Center Frequency (kHz)	Frequency (MHz)					
	1461	1499	1537	1600	1631	1662
100-400	No spur	No spur	No spur	No spur	No spur	No spur
400-600	No spur	No spur	No spur	No spur	498.51 kHz, -97 dBc	No spur
600-1000	No spur	No spur	No spur	No spur	No spur	No spur
1000-3000	2232.74 kHz, -100 dBc	2355.55 kHz, -103 dBc 2866.58 kHz, -101 dBc	No spur	2272.95 kHz, -103 dBc	No spur	No spur
≥ 3000	No spur	No spur	3551.30 kHz, -105 dBc	4478.81 kHz, -107 dBc	3306.59 kHz, -106 dBc	5074.89 kHz, -102 dBc

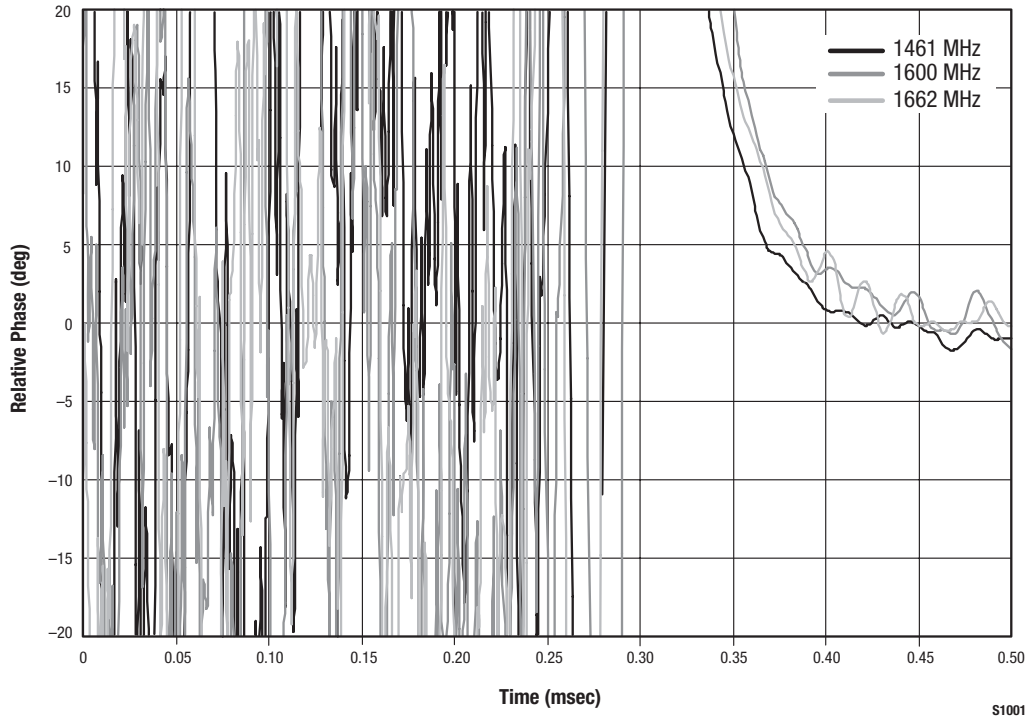

Figure 9. SKY73103-11 Settling Time Measurements

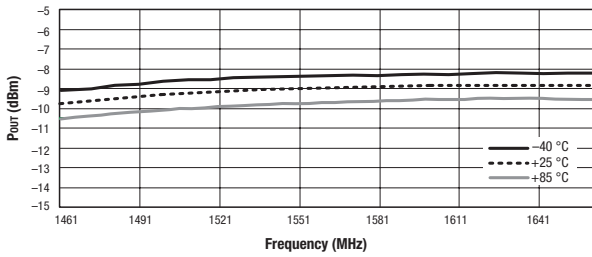

Figure 10. Output Power vs Frequency and Temperature

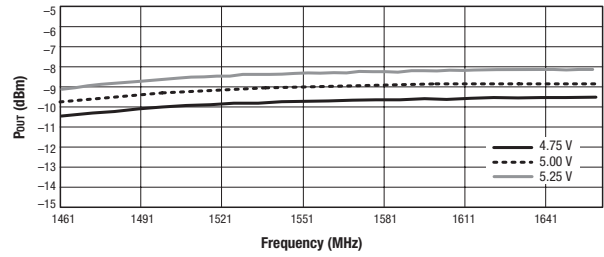

Figure 11. Output Power vs Frequency and Supply Voltage

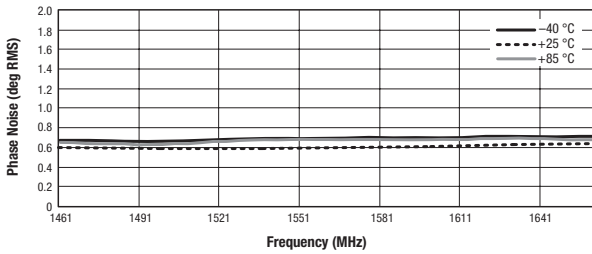

Figure 12. Integrated Phase Noise vs Frequency and Temperature

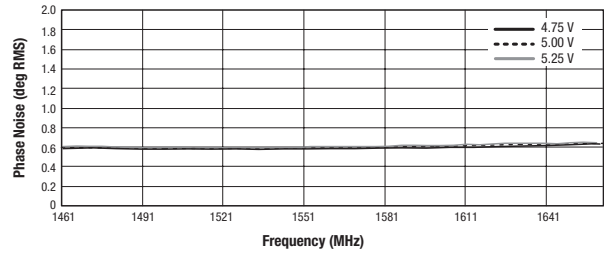

Figure 13. Integrated Phase Noise vs Frequency and Supply Voltage

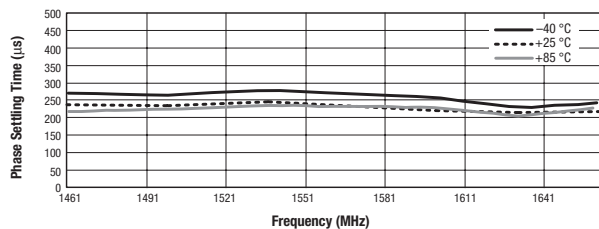

Figure 14. Phase Settling Time vs Frequency and Temperature

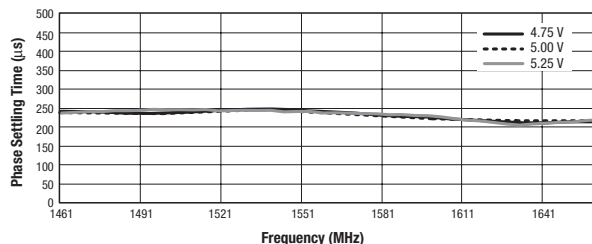

Figure 15. Phase Settling Time vs Frequency and Supply Voltage

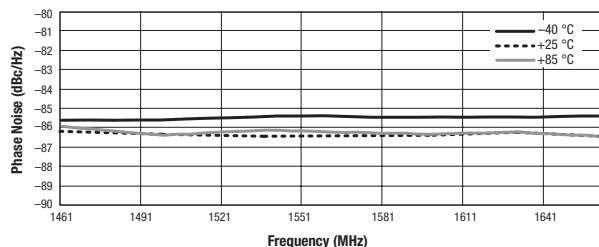

Figure 16. Phase Noise @ 10 kHz Offset vs Frequency and Temperature

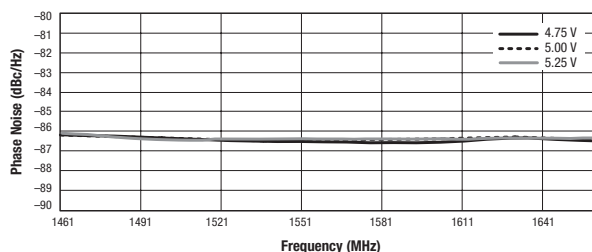

Figure 17. Phase Noise @ 10 kHz Offset vs Frequency and Supply Voltage

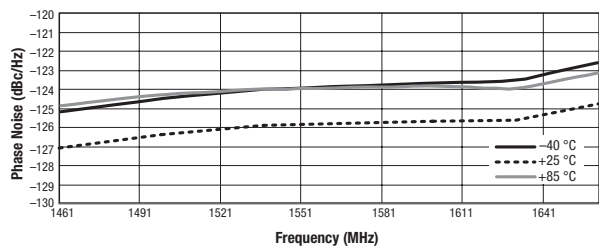

Figure 18. Phase Noise @ 200 kHz Offset vs Frequency and Temperature

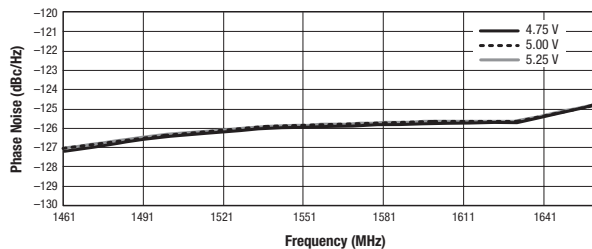

Figure 19. Phase Noise @ 200 kHz Offset vs Frequency and Supply Voltage

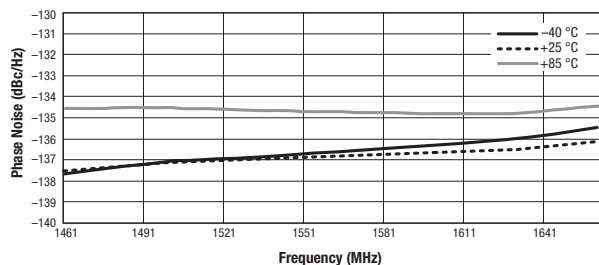

Figure 20. Phase Noise @ 400 kHz Offset vs Frequency and Temperature

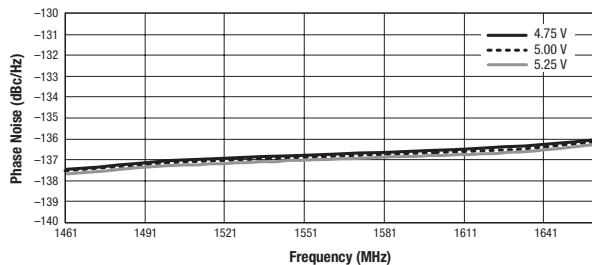

Figure 21. Phase Noise @ 400 kHz Offset vs Frequency and Supply Voltage

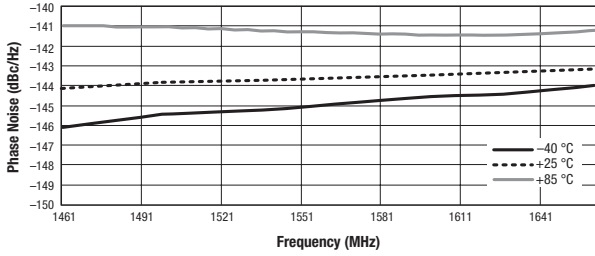

Figure 22. Phase Noise @ 800 kHz Offset vs Frequency and Temperature

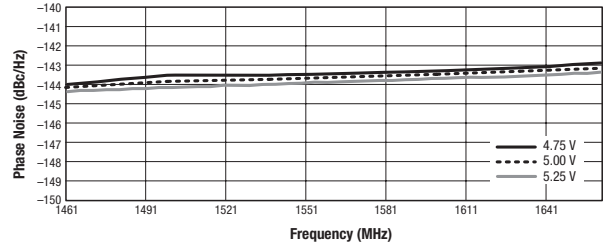

Figure 23. Phase Noise @ 800 kHz Offset vs Frequency and Supply Voltage

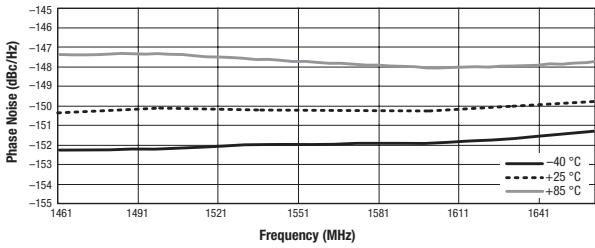

Figure 24. Phase Noise @ 1.8 MHz Offset vs Frequency and Temperature

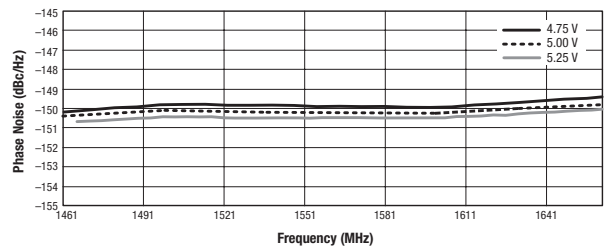

Figure 25. Phase Noise @ 1.8 MHz Offset vs Frequency and Supply Voltage

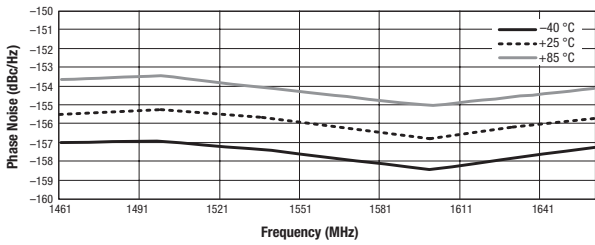

Figure 26. Phase Noise @ 6 MHz Offset vs Frequency and Temperature

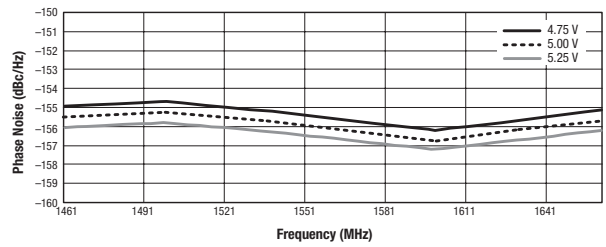
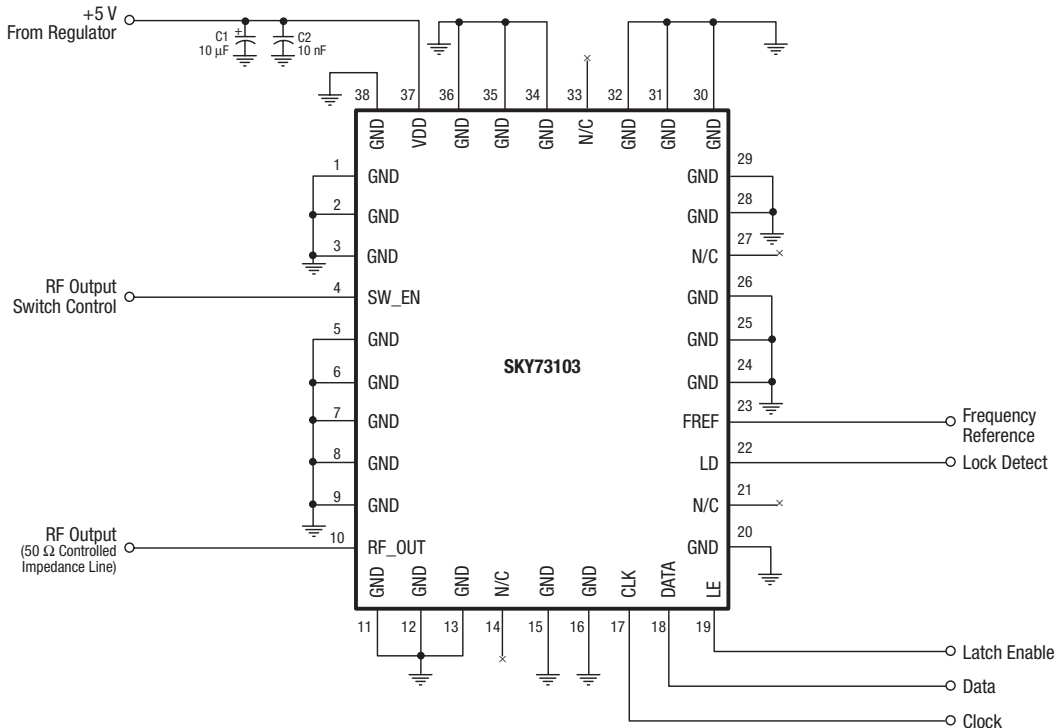

Figure 27. Phase Noise @ 6 MHz Offset vs Frequency and Supply Voltage



S962

Figure 28. SKY73103-11 Typical Application Schematic

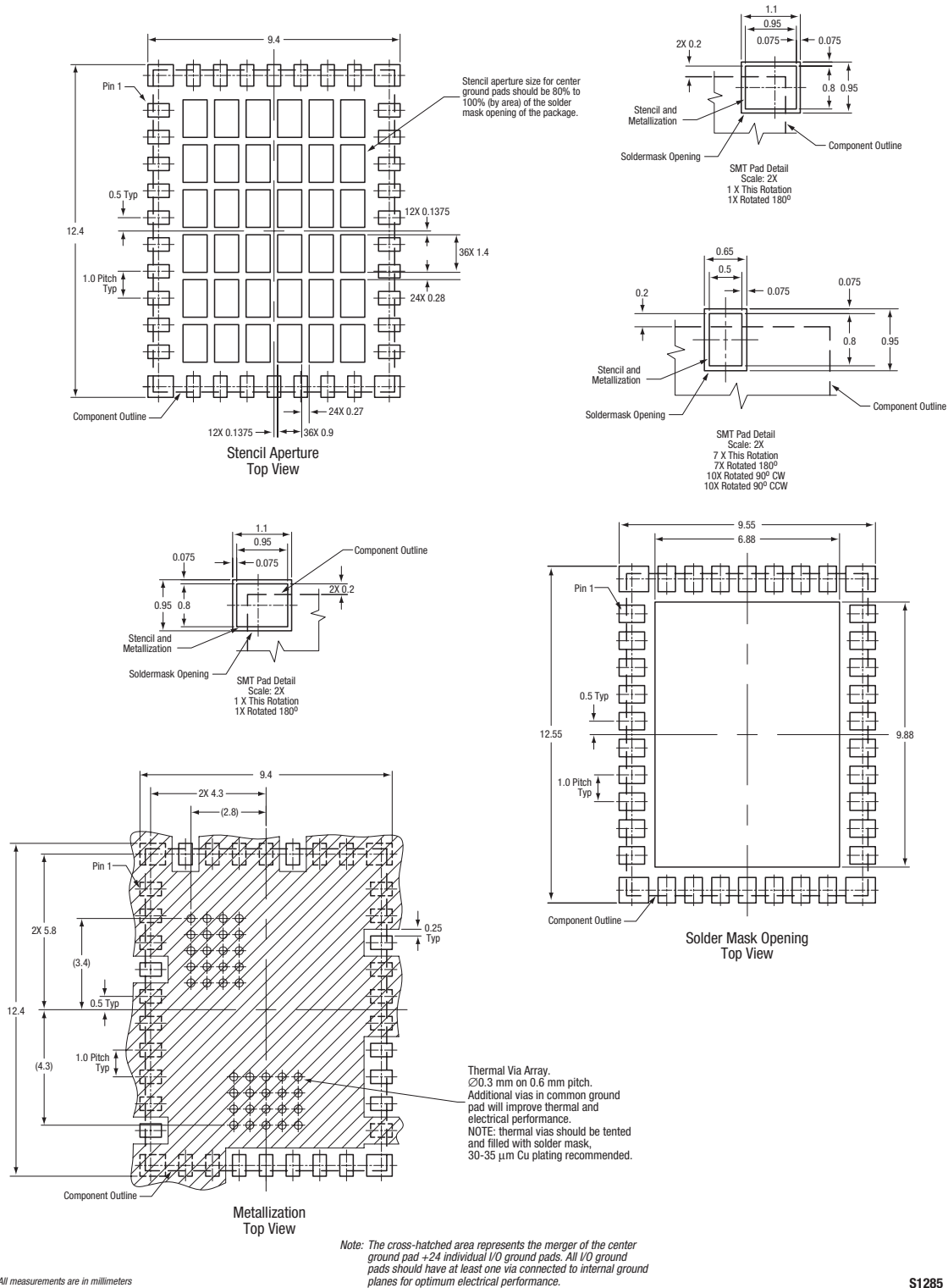
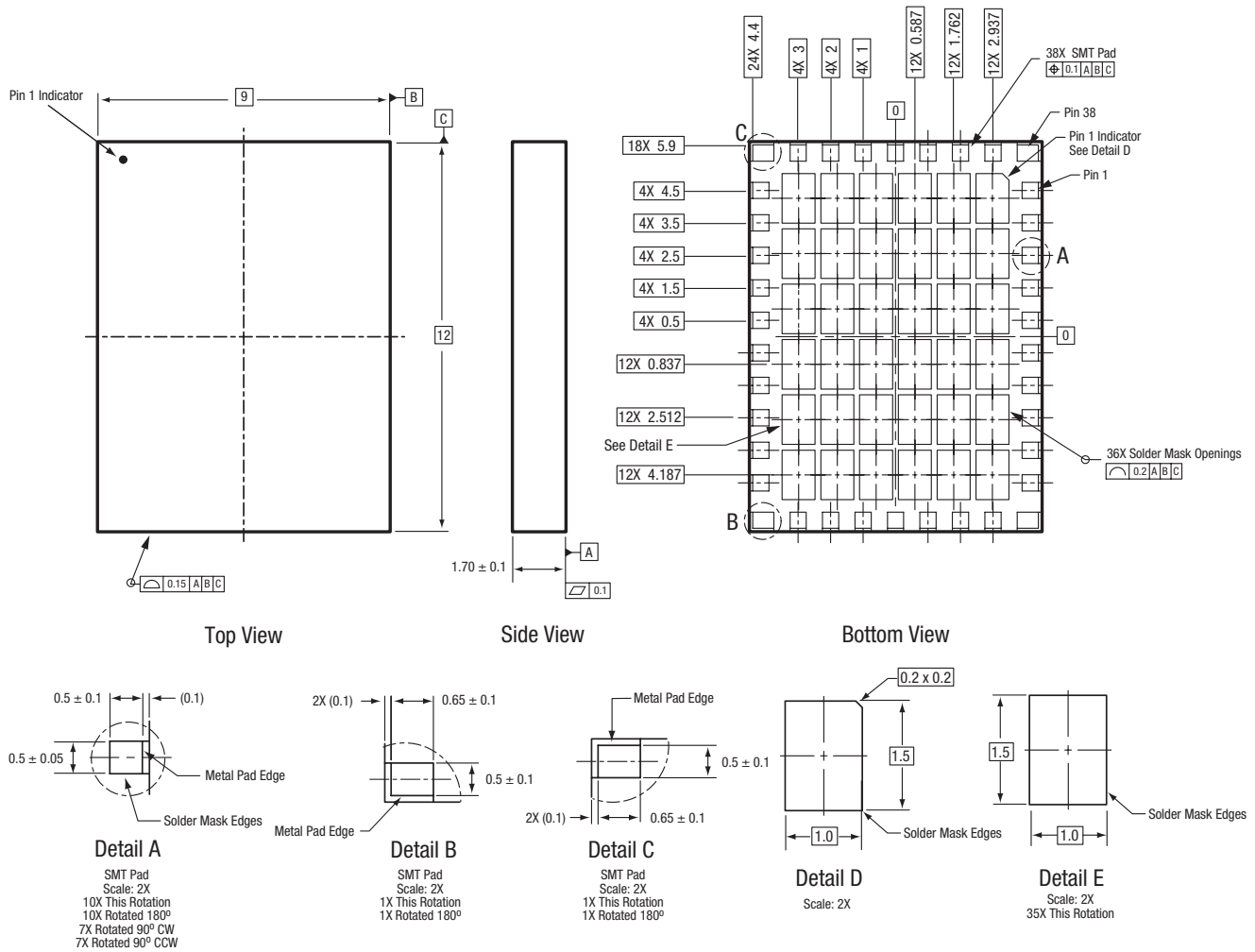

Figure 29. PCB Layout Footprint for the SKY73103-11 9 x 12 mm MCM



All measurements are in millimeters.

Dimensioning and tolerancing according to ASME Y14.5M-1994.

S1286

Figure 30. SKY73103-11 38-Pin MCM Package Dimensions

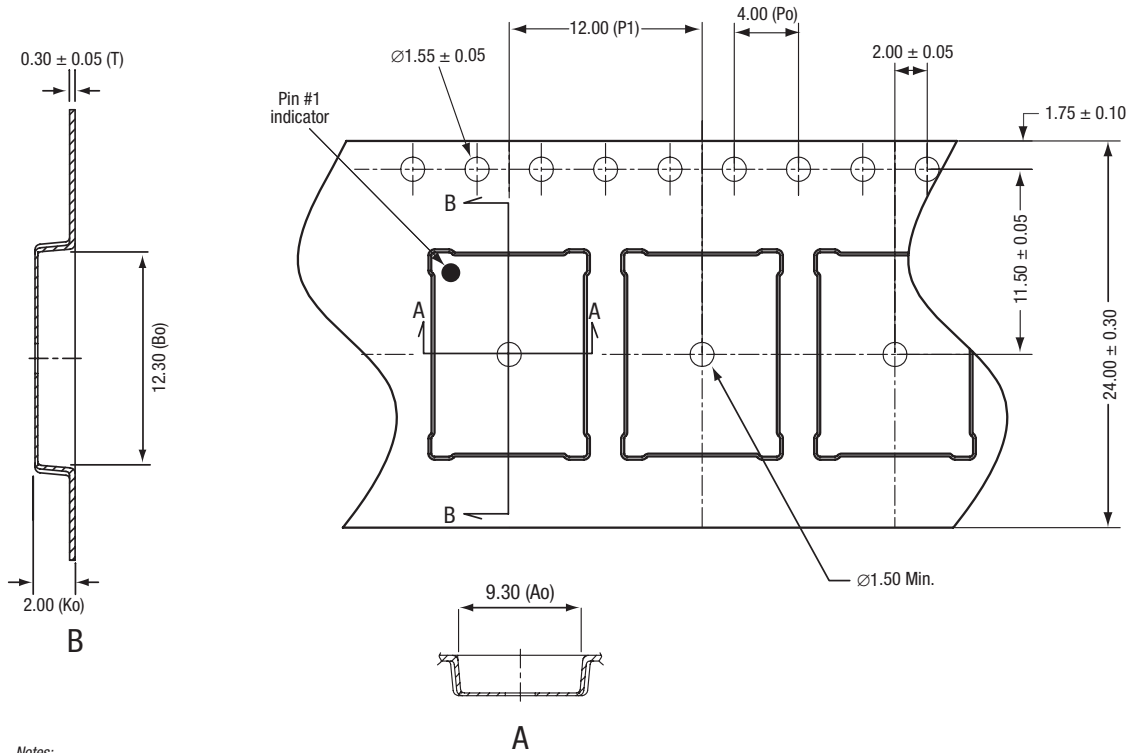

- Notes:
1. Carrier tape material: black conductive polystyrene
 2. Cover tape material: transparent conductive PSA
 3. Cover tape size: 21.3 mm width
 4. Po/P1 10 pitches cumulative tolerance on tape: ± 0.20 mm
 5. Ao and Bo measurement point to be 0.30 mm from bottom pocket
 6. All measurements are in millimeters

S1832

Figure 31. SKY73103-11 Tape and Reel Dimensions

Ordering Information

Model Name	Manufacturing Part Number	Evaluation Kit Part Number
SKY73103-11 1460-1665 MHz VCO/Synthesizer	SKY73103-11 (Pb-free package)	TW17-D770

Copyright © 2007, 2008, 2009 Skyworks Solutions, Inc. All Rights Reserved.

Information in this document is provided in connection with Skyworks Solutions, Inc. (“Skyworks”) products or services. These materials, including the information contained herein, are provided by Skyworks as a service to its customers and may be used for informational purposes only by the customer. Skyworks assumes no responsibility for errors or omissions in these materials or the information contained herein. Skyworks may change its documentation, products, services, specifications or product descriptions at any time, without notice. Skyworks makes no commitment to update the materials or information and shall have no responsibility whatsoever for conflicts, incompatibilities, or other difficulties arising from any future changes.

No license, whether express, implied, by estoppel or otherwise, is granted to any intellectual property rights by this document. Skyworks assumes no liability for any materials, products or information provided hereunder, including the sale, distribution, reproduction or use of Skyworks products, information or materials, except as may be provided in Skyworks Terms and Conditions of Sale.

THE MATERIALS, PRODUCTS AND INFORMATION ARE PROVIDED “AS IS” WITHOUT WARRANTY OF ANY KIND, WHETHER EXPRESS, IMPLIED, STATUTORY, OR OTHERWISE, INCLUDING FITNESS FOR A PARTICULAR PURPOSE OR USE, MERCHANTABILITY, PERFORMANCE, QUALITY OR NON-INFRINGEMENT OF ANY INTELLECTUAL PROPERTY RIGHT; ALL SUCH WARRANTIES ARE HEREBY EXPRESSLY DISCLAIMED. SKYWORKS DOES NOT WARRANT THE ACCURACY OR COMPLETENESS OF THE INFORMATION, TEXT, GRAPHICS OR OTHER ITEMS CONTAINED WITHIN THESE MATERIALS. SKYWORKS SHALL NOT BE LIABLE FOR ANY DAMAGES, INCLUDING BUT NOT LIMITED TO ANY SPECIAL, INDIRECT, INCIDENTAL, STATUTORY, OR CONSEQUENTIAL DAMAGES, INCLUDING WITHOUT LIMITATION, LOST REVENUES OR LOST PROFITS THAT MAY RESULT FROM THE USE OF THE MATERIALS OR INFORMATION, WHETHER OR NOT THE RECIPIENT OF MATERIALS HAS BEEN ADVISED OF THE POSSIBILITY OF SUCH DAMAGE.

Skyworks products are not intended for use in medical, lifesaving or life-sustaining applications, or other equipment in which the failure of the Skyworks products could lead to personal injury, death, physical or environmental damage. Skyworks customers using or selling Skyworks products for use in such applications do so at their own risk and agree to fully indemnify Skyworks for any damages resulting from such improper use or sale.

Customers are responsible for their products and applications using Skyworks products, which may deviate from published specifications as a result of design defects, errors, or operation of products outside of published parameters or design specifications. Customers should include design and operating safeguards to minimize these and other risks. Skyworks assumes no liability for applications assistance, customer product design, or damage to any equipment resulting from the use of Skyworks products outside of stated published specifications or parameters.

Skyworks, the Skyworks symbol, and “Breakthrough Simplicity” are trademarks or registered trademarks of Skyworks Solutions, Inc., in the United States and other countries. Third-party brands and names are for identification purposes only, and are the property of their respective owners. Additional information, including relevant terms and conditions, posted at www.skyworksinc.com, are incorporated by reference.