

SKiiP 25ACI12T4V2



MiniSKiiP® AC IPM

3-phase bridge inverter
intelligent power module

SKiiP 25ACI12T4V2

Features

- Contact springs for solder-free and quick assembly
- Trench-Field-Stop IGBT
- Freewheeling diodes in CAL technology
- HVIC gate driver in SOI technology with advanced level shifter
- Matched propagation delay
- Over-current and under-voltage detection
- Interlock logic for cross conduction protection
- Multi-purpose error input
- Integrated temperature sensor (NTC)
- RoHs compliant
- UL recognised file no. E63532

Typical Applications*

- Industrial & consumer drives
- Power supplies (SMPS & UPS)

Remarks

- Product reliability results valid for $T_j \leq 150^\circ\text{C}$
- Case temp. limited to $T_c = 125^\circ\text{C}$ max. (for baseplateless modules $T_c = T_s$)

Footnotes

¹⁾ Please refer to Technical Explanations

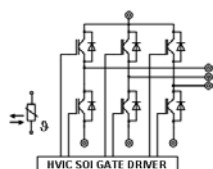

ACI

Absolute Maximum Ratings				
Symbol	Conditions		Values	Unit
Inverter - IGBT				
V_{CES}	$T_j = 25^\circ\text{C}$		1200	V
I_C	$T_j = 175^\circ\text{C}$	$T_s = 25^\circ\text{C}$	62	A
		$T_s = 70^\circ\text{C}$	50	A
I_{Cnom}			50	A
I_{CRM}	$I_{CRM} = 3 \times I_{Cnom}$		150	A
t_{psc}	$V_{CC} = 800\text{ V}$	$T_j = 150^\circ\text{C}$	10	μs
	$V_{GE} \leq 15\text{ V}$			
	$V_{CES} \leq 1200\text{ V}$			
T_j			-40 ... 175	$^\circ\text{C}$
Inverse - Diode				
I_F	$T_j = 175^\circ\text{C}$	$T_s = 25^\circ\text{C}$	59	A
		$T_s = 70^\circ\text{C}$	47	A
I_{Fnom}			50	A
I_{FRM}	$I_{FRM} = 3 \times I_{Fnom}$		150	A
I_{FSM}	$t_p = 10\text{ ms, sin } 180^\circ, T_j = 150^\circ\text{C}$		270	A
T_j			-40 ... 175	$^\circ\text{C}$
Driver				
VCC	VCC-VSS, VCCL-VSSL		17	V
VBx	VB1-U, VB2-V, VB3-W		17	V
Vsx	Voltage to VSS		-3 ... 1200	V
V_{in}	HINx-VSS, LINx-VSS, /ERRIN-VSS		VSS-0.3 ... VCC+0.3	V
V_{oErr}	/ERROUT-VSS		VSS-0.3 ... VCC+0.3	V
$I_{max(EO)}$	/ERROUT-VSS		10	mA
V_{ITRIP}	ITRIP-VSS		VSS-0.3 ... VCC+0.3	V
Module				
T_c			-40 ... 125	$^\circ\text{C}$
T_{stg}			-40 ... 125	$^\circ\text{C}$
V_{isol}	AC sinus 50Hz, all pins to heat sink, 1 min		2500	V
$I_t(\text{RMS})$	$T_{terminal} = 80^\circ\text{C}, 20\text{A per spring}$		60	A

Characteristics						
Symbol	Conditions		min.	typ.	max.	Unit
Inverter - IGBT						
$V_{CE(sat)}$	$I_C = 50\text{ A}$ $V_{GE} = 15\text{ V}$ chipelevel	$T_j = 25^\circ\text{C}$	1.85	2.10		V
		$T_j = 150^\circ\text{C}$	2.20	2.40		V
V_{CE0}	chipelevel	$T_j = 25^\circ\text{C}$	0.8	0.9		V
		$T_j = 150^\circ\text{C}$	0.7	0.8		V
r_{CE}	$V_{GE} = 15\text{ V}$ chipelevel	$T_j = 25^\circ\text{C}$	21	24		$\text{m}\Omega$
		$T_j = 150^\circ\text{C}$	30	32		$\text{m}\Omega$
I_{CES}	$V_{GE} = 0\text{ V}$ $V_{CE} = 1200\text{ V}$	$T_j = 25^\circ\text{C}$	0.1	0.3		mA
						mA
Q_G	0 V ... +15 V		220			nC
$t_{d(on)}$			$T_j = 150^\circ\text{C}$		943	ns
t_r	$V_{CC} = 600\text{ V}$		$T_j = 150^\circ\text{C}$		47	ns
E_{on}	$I_C = 50\text{ A}$		$T_j = 150^\circ\text{C}$		6.6	mJ
$t_{d(off)}$	$V_{GE} = +15/0\text{ V}$ ¹⁾		$T_j = 150^\circ\text{C}$		1613	ns
t_f			$T_j = 150^\circ\text{C}$		69	ns
E_{off}			$T_j = 150^\circ\text{C}$		5.7	mJ
$R_{th(j-s)}$	per IGBT				0.84	K/W

SKiiP 25ACI12T4V2



MiniSKiiP® AC IPM

3-phase bridge inverter intelligent power module

SKiiP 25ACI12T4V2

Features

- Contact springs for solder-free and quick assembly
- Trench-Field-Stop IGBT
- Freewheeling diodes in CAL technology
- HVIC gate driver in SOI technology with advanced level shifter
- Matched propagation delay
- Over-current and under-voltage detection
- Interlock logic for cross conduction protection
- Multi-purpose error input
- Integrated temperature sensor (NTC)
- RoHs compliant
- UL recognised file no. E63532

Typical Applications*

- Industrial & consumer drives
- Power supplies (SMPS & UPS)

Remarks

- Product reliability results valid for $T_j \leq 150^\circ\text{C}$
- Case temp. limited to $T_c = 125^\circ\text{C}$ max. (for baseplateless modules $T_c = T_s$)

Footnotes

¹⁾ Please refer to Technical Explanations

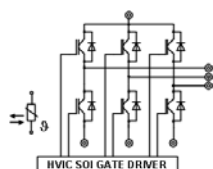

ACI

Characteristics						
Symbol	Conditions		min.	typ.	max.	Unit
Inverse diode						
$V_F = V_{EC}$	$I_F = 50\text{ A}$ $V_{GE} = 0\text{ V}$ chipllevel	$T_j = 25^\circ\text{C}$		2.25	2.5	V
		$T_j = 150^\circ\text{C}$		2.2	2.5	V
V_{F0}	chipllevel	$T_j = 25^\circ\text{C}$		1.3	1.5	V
		$T_j = 150^\circ\text{C}$		0.9	1.1	V
r_F	chipllevel	$T_j = 25^\circ\text{C}$		18	21	m Ω
		$T_j = 150^\circ\text{C}$		26	28	m Ω
I_{RRM}	$I_F = 50\text{ A}$	$T_j = 150^\circ\text{C}$		51		A
Q_{rr}	$V_{GE} = 0\text{ V}$	$T_j = 150^\circ\text{C}$		8.5		μC
E_{rr}	$V_{CC} = 600\text{ V}$	$T_j = 150^\circ\text{C}$		3		mJ
$R_{th(j-s)}$	per Diode			0.99		K/W
Driver						
VCC	VCC-VSS, VCCL-VSSL ¹⁾			15		V
ICC ₀	Quiescent current, VCC=15V ¹⁾				8.5	mA
VBx	VB1-U, VB2-V, VB2-W ¹⁾			15		V
IBx	Quiescent high side driver supply current per channel, VBx=15V ¹⁾			80	90	μA
V_{IT+}	Input threshold voltage (HIGH) ¹⁾			2	2.4	V
V_{IT-}	Input threshold voltage (LOW) ¹⁾		0.8	0.9		V
V_{ITRIP+}	ITRIP set threshold voltage ¹⁾			0.47	0.6	V
V_{ITRIP-}	ITRIP reset threshold voltage ¹⁾		0.35	0.41		V
V_{oErr}	Error output, open drain ¹⁾				15	V
V_{UV}	Supply under-voltage protection set ¹⁾		10.5	11.1		V
V_{UVr}	Supply under-voltage protection reset ¹⁾			11.5	12.3	V
$t_{d,ITRIP}$	ITRIP to LOUTx/HOUTx shutdown propagation delay (W-phase)			820		ns
t_{SIS}	PWM short pulse suppression			0.5		μs
t_{TD}	Interlock dead time			0.58		μs
f_{SW}	Switching frequency				25	kHz
Temperatur Sensor						
R_{25}	$T_r = 25^\circ\text{C}$ ¹⁾			$5.0 \pm 5\%$		k Ω
Module						
M_s	to heat sink		2		2.5	Nm
w	weight			55		g

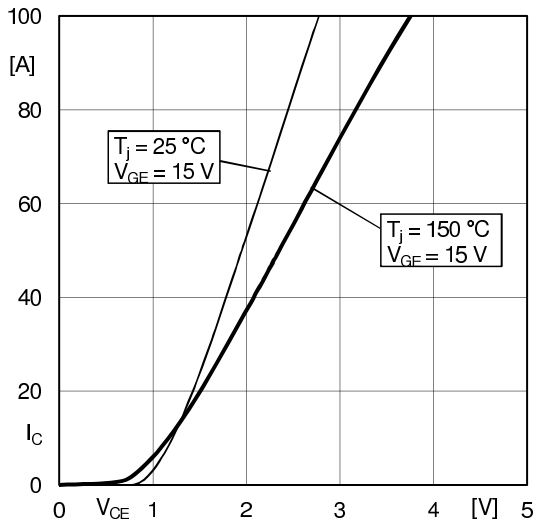

Fig. 1: Typ. output characteristic

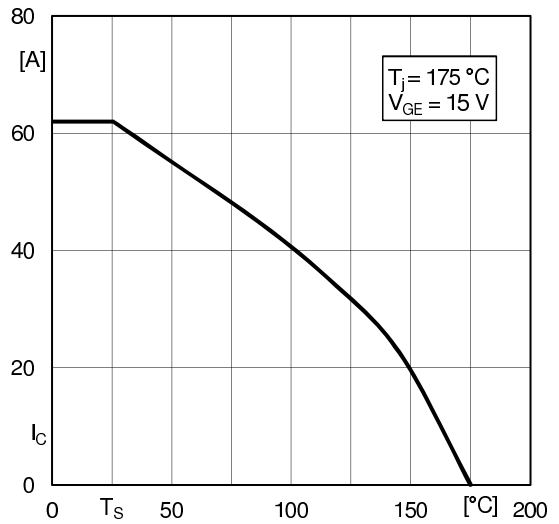

Fig. 2: Typ. rated current vs. temperature $I_C = f(T_S)$

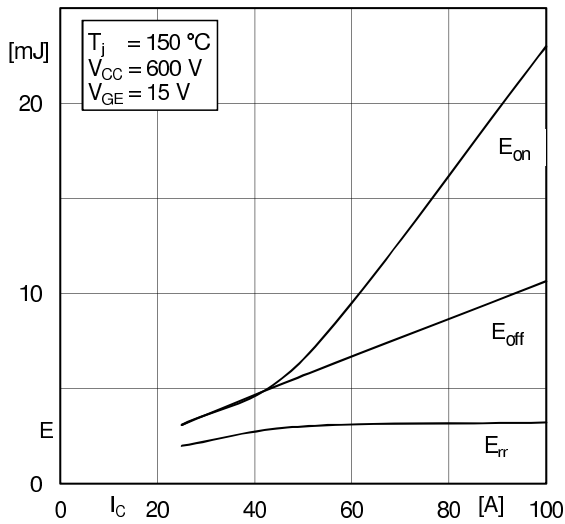

Fig. 3: Typ. turn-on /-off energy = $f(I_C)$

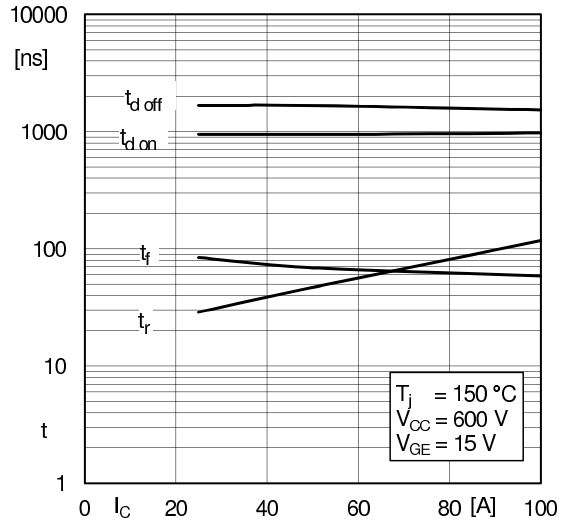

Fig. 4: Typ. switching times vs. I_C

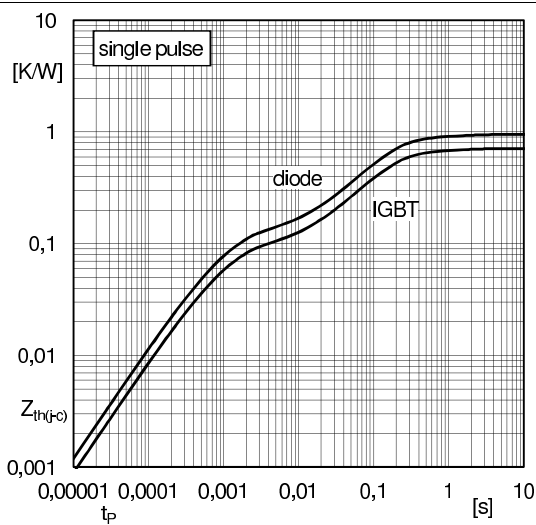

Fig. 5: Transient thermal impedance of IGBT and diode

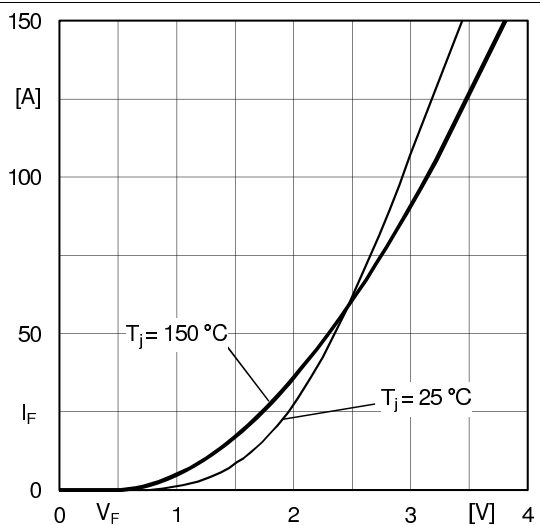
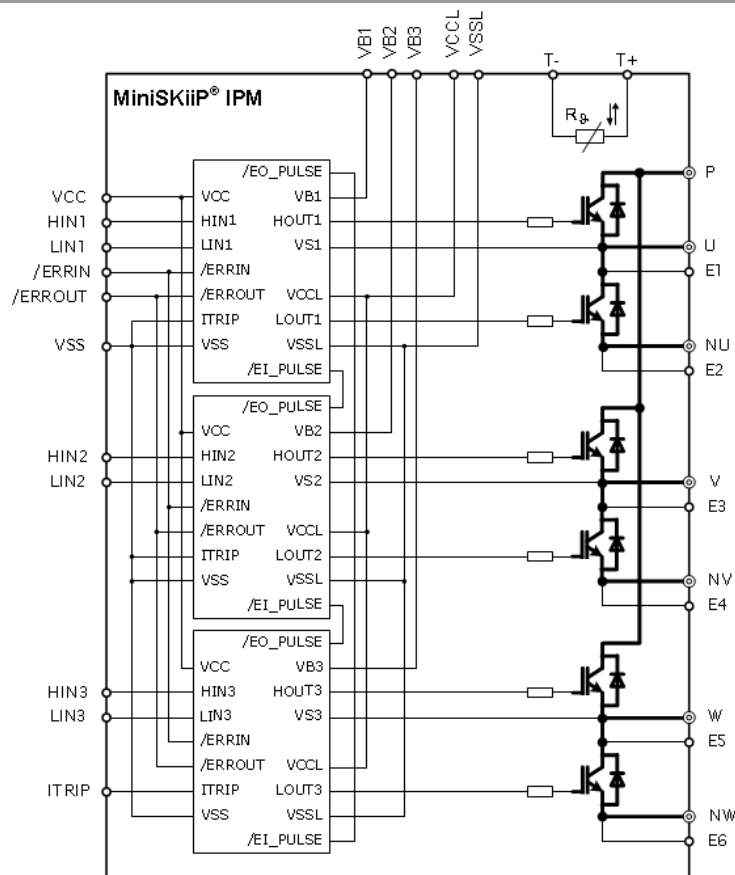

Fig. 6: Typ. freewheeling diode forward characteristic



Internal circuit

Pin	Signal	Description
1	VB1	Floating supply voltage for phase U high side IGBT
2	HIN1	PWM signal input for phase U high side switch
3	LIN1	PWM signal input for phase U low side switch
4	HIN2	PWM signal input for phase V high side switch
5	VCC	Driver IC main supply voltage
6	HIN3	PWM signal input for phase W high side switch
7	/ERRIN	Multi-purpose error input for common shut-down (low active)
8	VSS	Driver IC supply voltage ground
9	/ERROUT	Error logic output (low active)
10	ITRIP	Comparator input / current sense input for overcurrent shut-down
11	VSSL	Low side supply voltage ground
12	VCCL	Low side supply voltage
13	VB2	Floating supply voltage for phase V high side IGBT
14	VB3	Floating supply voltage for phase W high side IGBT
15	LIN2	PWM signal input for phase V low side switch
16	LIN3	PWM signal input for phase W low side switch
U	U	Phase U AC terminal
E1	E1	Auxiliary emitter terminal of phase U high side IGBT
V	V	Phase V AC terminal
E3	E3	Auxiliary emitter terminal of phase V high side IGBT
W	W	Phase W AC terminal
E5	E5	Auxiliary emitter terminal of phase W high side IGBT
NU	NU	Phase U -DC terminal
E2	E2	Auxiliary emitter terminal of phase U low side IGBT
NV	NV	Phase V -DC terminal
E4	E4	Auxiliary emitter terminal of phase V low side IGBT
NW	NW	Phase W -DC terminal
E6	E6	Auxiliary emitter terminal of phase W low side IGBT
P	P	+DC terminal
+T	+T	Temperature sensor terminal (+)
-T	-T	Temperature sensor terminal (-)

Pin and signal description

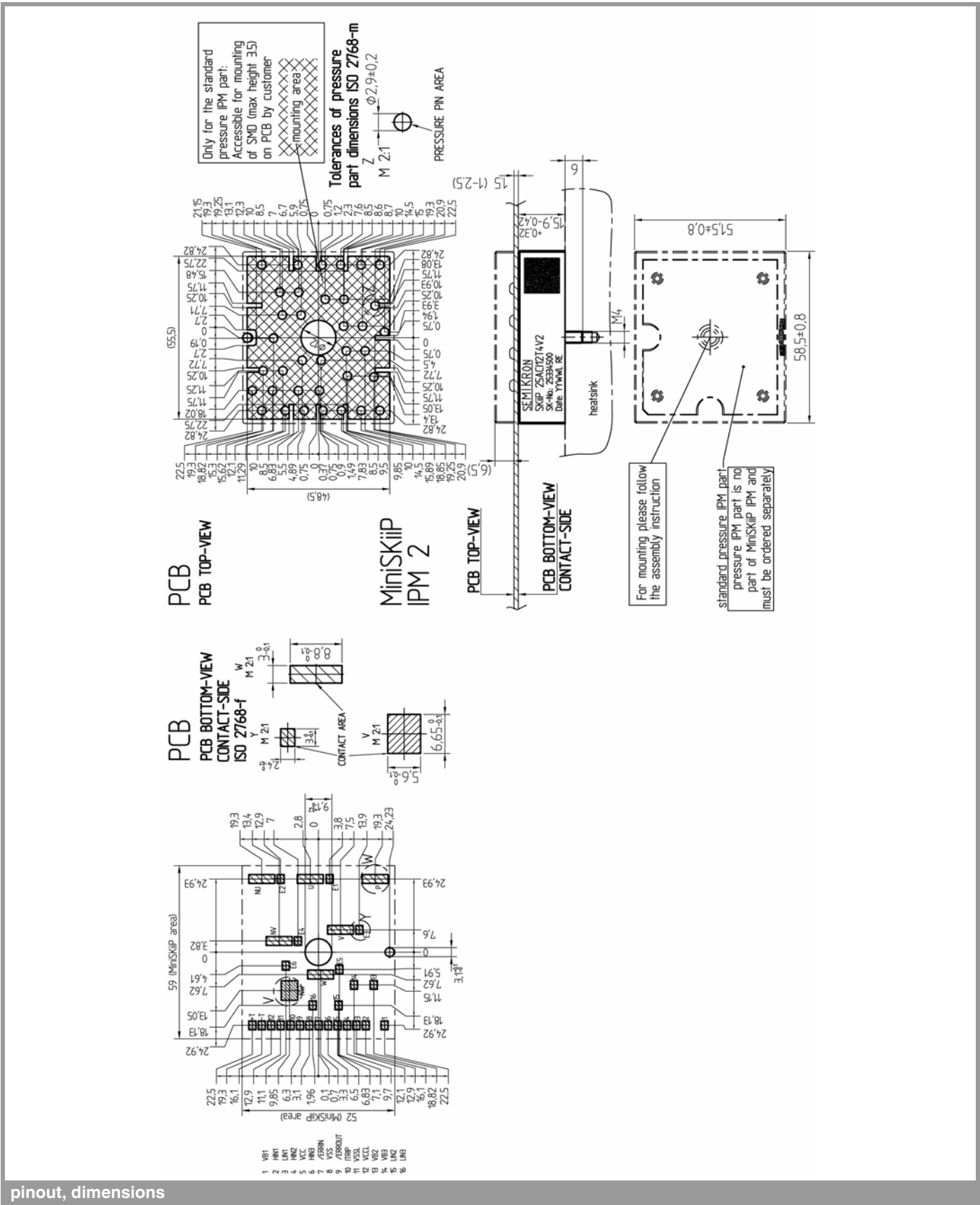

This is an electrostatic discharge sensitive device (ESDS), international standard IEC 60747-1, Chapter IX

* The specifications of our components may not be considered as an assurance of component characteristics. Components have to be tested for the respective application. Adjustments may be necessary. The use of SEMIKRON products in life support appliances and systems is subject to prior specification and written approval by SEMIKRON. We therefore strongly recommend prior consultation of our staff.